

FLUKE®

2680A/2686A

Data Acquisition System/Data Logging System

Users Manual

June 2002, Rev. 1, 4/04

© 2002, 2004 Fluke Corporation. All rights reserved.

All product names are trademarks of their respective companies.

Limited Warranty and Limitation of Liability

Each Fluke product is warranted to be free from defects in material and workmanship under normal use and service. The warranty period is one year and begins on the date of shipment. Parts, product repairs and services are warranted for 90 days. This warranty extends only to the original buyer or end-user customer of a Fluke authorized reseller, and does not apply to fuses, disposable batteries or to any product which, in Fluke's opinion, has been misused, altered, neglected, contaminated, or damaged by accident or abnormal conditions of operation or handling.

Fluke warrants that software will operate substantially in accordance with its functional specifications for 90 days and that it has been properly recorded on non-defective media. Fluke does not warrant that software will be error free or operate without interruption. The software is neither intended nor warranted for use in medical or any other applications where human safety may be a concern.

Fluke authorized resellers shall extend this warranty on new and unused products to end-user customers only but have no authority to extend a greater or different warranty on behalf of Fluke. Warranty support is available only if product is purchased through a Fluke authorized sales outlet or Buyer has paid the applicable international price. Fluke reserves the right to invoice Buyer for importation costs of repair/replacement parts when product purchased in one country is submitted for repair in another country.

Fluke's warranty obligation is limited, at Fluke's option, to refund of the purchase price, free of charge repair, or replacement of a defective product which is returned to a Fluke authorized service center within the warranty period.

To obtain warranty service, contact your nearest Fluke authorized service center to obtain return authorization information, then send the product to that service center, with a description of the difficulty, postage and insurance prepaid (FOB Destination). Fluke assumes no risk for damage in transit. Following warranty repair, the product will be returned to Buyer, transportation prepaid (FOB Destination). If Fluke determines that failure was caused by neglect, misuse, contamination, alteration, accident or abnormal condition of operation or handling, including overvoltage failures caused by use outside the product's specified rating, or normal wear and tear of mechanical components, Fluke will provide an estimate of repair costs and obtain authorization before commencing the work. Following repair, the product will be returned to the Buyer transportation prepaid and the Buyer will be billed for the repair and return transportation charges (FOB Shipping Point).

THIS WARRANTY IS BUYER'S SOLE AND EXCLUSIVE REMEDY AND IS IN LIEU OF ALL OTHER WARRANTIES, EXPRESS OR IMPLIED, INCLUDING BUT NOT LIMITED TO ANY IMPLIED WARRANTY OF MERCHANTABILITY OR FITNESS FOR A PARTICULAR PURPOSE. FLUKE SHALL NOT BE LIABLE FOR ANY SPECIAL, INDIRECT, INCIDENTAL OR CONSEQUENTIAL DAMAGES OR LOSSES AND/OR PROFITS, INCLUDING LOSS OF DATA, ARISING FROM ANY CAUSE OR THEORY.

Since some countries or states do not allow limitation of the term of an implied warranty, or exclusion or limitation of incidental or consequential damages, the limitations and exclusions of this warranty may not apply to every buyer. If any provision of this Warranty is held invalid or unenforceable by a court or other decision-maker of competent jurisdiction, such holding will not affect the validity or enforceability of any other provision.

Fluke Corporation
P.O. Box 9090
Everett, WA 98206-9090
U.S.A.

Fluke Europe B.V.
P.O. Box 1186
5602 BD Eindhoven
The Netherlands

⚠️⚠️ Caution

This is an IEC safety Class 1 product. Before using, the ground wire in the line cord or rear panel binding post must be connect to an earth ground for safety.

Interference Information

This equipment generates and uses radio frequency energy and if not installed and used in strict accordance with the manufacturer's instructions, may cause interference to radio and television reception. It has been type tested and found to comply with the limits for a Class B computing device in accordance with the specifications of Part 15 of FCC Rules, which are designed to provide reasonable protection against such interference in a residential installation.

Operation is subject to the following two conditions:

- This device may not cause harmful interference.
- This device must accept any interference received, including interference that may cause undesired operation.

There is no guarantee that interference will not occur in a particular installation. If this equipment does cause interference to radio or television reception, which can be determined by turning the equipment off and on, the user is encouraged to try to correct the interference by one of more of the following measures:

- Reorient the receiving antenna
- Relocate the equipment with respect to the receiver
- Move the equipment away from the receiver
- Plug the equipment into a different outlet so that the computer and receiver are on different branch circuits

If necessary, the user should consult the dealer or an experienced radio/television technician for additional suggestions. The user may find the following booklet prepared by the Federal Communications Commission helpful: How to Identify and Resolve Radio-TV Interference Problems. This booklet is available from the U.S. Government Printing Office, Washington, D.C. 20402. Stock No. 004-000-00345-4.

SAFETY TERMS IN THIS MANUAL

This device has been designed and tested to meet the requirements of EN61010-1 (Safety Requirements for Electrical Equipment for Measurement, Control and Laboratory Use). It is an Installation Category II device intended for operation from a normal single phase supply. The DIO relay controls are rated to 250 V ac CAT I and should not be used in applications that exceed that rating. This Users Manual contains information, warnings and cautions. Use of this equipment in a manner not specified herein may impair the protection provided by the equipment.

Measurement category I is for measurements performed on circuits not directly connected to MAINS. Examples are measurements on circuits not derived from MAINS, and specially protected (internal) MAINS derived circuits.

Measurement category II is for measurements performed on circuits directly connected to the low voltage installation. Examples are measurements on household appliances, portable tools and similar equipment.

⚠ ⚠ WARNING statements identify conditions or practices that could result in personal injury or loss of life.

⚠ ⚠ CAUTION statements identify conditions or practices that could result in damage to equipment.

SYMBOLS MARKED ON EQUIPMENT:



WARNING Risk of electric shock.



Ground (earth) terminal.



Protective ground (earth) terminal. Must be connected to safety earth ground when the power cord is used.



Attention. Refer to the manual. This symbol indicates that information about usage of a feature is contained in the manual. This symbol appears on the Universal Input Module and in the following two places on the device rear panel:

1. Ground Binding Post (to the left of the line power connector).
2. Alarm/Trigger I/O and Digital I/O connectors.

AC POWER SOURCE

The device is intended to operate from an ac power source that will not apply more than 264 V ac rms between the supply conductors or between either supply conductor and ground. A protective ground connection by way of the grounding conductor in the power cord is required for safe operation.

⚠️⚠️WARNING

Use the proper fuse. To avoid fire hazard, for fuse replacement use only a 1/2 ampere, 250 V time delay line fuse.

DC POWER SOURCE

The device may also be operated from a 9 V to 45 V dc power source when either the rear panel ground binding post or the power cord grounding conductor is connected properly. The input is protected by a 4 ampere fuse internal to the device. This fuse should only be replaced by a qualified Fluke technician.

GROUNDING THE DEVICE

The device utilizes controlled overvoltage techniques that require the device to be grounded whenever normal mode or common mode ac voltages or transient voltages may occur. The enclosure must be grounded through the grounding conductor of the power cord, or if operated on battery with the power cord unplugged, through the rear panel ground binding post.

USE THE PROPER POWER CORD

Use only the power cord and connector appropriate for the voltage and plug configuration in your country.

Use only a power cord that is in good condition.

Refer power cord and connector changes to qualified service personnel.

⚠️⚠️WARNING

To avoid possible electric shock or damage to the device:

- **Read manual before operating.**
- **Do not position device so that air flow through side vents is restricted.**
- **Do not use in a manner not specified in this manual or safety protection may be impaired.**
- **Disconnect power cord and ALL other inputs before replacing a fuse.**
- **Position the device where power cord can be disconnected.**
- **Do not exceed maximum voltages.**

⚠️⚠️ WARNING

- **Do not operate in explosive atmospheres.**
- **To avoid personal injury or death, do not remove the device cover without first removing the power source connected to the rear panel. Do not operate the device without the cover properly installed. There is no need for the operator to remove the cover.**
- **Do not attempt to operate if protection may be impaired.**
- **If the device appears damaged or operates abnormally, protection may be impaired. Do not attempt to operate the device under these conditions. Refer all question of proper device operation to qualified service personnel.**
- **Do not attempt to service unless you are a Fluke qualified repair technician.**
- **To avoid personal injury or death, remove the AC power cord and all analog and digital connector modules before servicing the device.**

Note

All signals must be removed from the analog and digital connector wiring before opening the connector modules.

The following table provides additional safety information.

General Specifications

Specification	Characteristic								
Size	473 mm (18.6 in) x 432 mm (17 in) x 237 mm (9.3 in)								
Weight	<table> <tr> <td>2680A/2686A (empty)</td> <td>8.6 Kg (18.9 lb)</td> </tr> <tr> <td>2680A – FAI</td> <td>0.8 Kg (1.8 lb)</td> </tr> <tr> <td>2680A – PAI</td> <td>1.2 Kg (2.7 lb)</td> </tr> <tr> <td>2680A – DIO</td> <td>0.8 Kg (1.8 lb)</td> </tr> </table>	2680A/2686A (empty)	8.6 Kg (18.9 lb)	2680A – FAI	0.8 Kg (1.8 lb)	2680A – PAI	1.2 Kg (2.7 lb)	2680A – DIO	0.8 Kg (1.8 lb)
2680A/2686A (empty)	8.6 Kg (18.9 lb)								
2680A – FAI	0.8 Kg (1.8 lb)								
2680A – PAI	1.2 Kg (2.7 lb)								
2680A – DIO	0.8 Kg (1.8 lb)								
Power	100 – 240 V ac (no switching required), 50 to 60 Hz, 100 VA maximum or optional 9 V dc to 45 V dc, 35 W maximum								
EMC	EN50082-2 EN55022-1 EN55011 class A EN610000-4-2,3,4,6,8 EN61326								
Safety	EN61010-1, CAT II CSA C22.2 No. 1010.1								
Operating Temperature Range	-20 °C to 60 °C (-4 °F to +140 °F)								
Storage Temperature Range	-40 °C to 70 °C (-40 °F to +158 °F)								
Relative Humidity	90% maximum for -10 °C to 28 °C (14 °F to +82 °F) 75% maximum for 28 °C to 35 °C (82 °F to +95 °F) 50% maximum for 35 °C to 60 °C (95 °F to +140 °F) (3 MΩ range, reduce humidity rating by 25% for 1 hour warm-up. 3 MΩ range meets full humidity ratings with 2 hour warm-up)								
Altitude	Operating: 2,000 m (6,562 ft) maximum Non-operating: 12,200 m (40,000 ft) maximum								

Table of Contents

Chapter	Title	Page
1	Overview	1-1
	Introduction.....	1-3
	Contacting Fluke.....	1-3
	Instrument Features and Capabilities.....	1-5
	Mainframe Features.....	1-8
	Trigger Input.....	1-8
	Trigger Output.....	1-8
	PC Card ATA Interface (2686A Only).....	1-8
	Master Alarm.....	1-9
	Interval Trigger.....	1-9
	External Trigger.....	1-9
	Alarms.....	1-9
	Channel Monitoring.....	1-10
	Alarm Trigger.....	1-10
	Channel Numbering.....	1-10
	Computed Channels.....	1-11
	Mx+B Scaling.....	1-11
	Analog Channels.....	1-11
	Digital I/O Module Option.....	1-12
	Digital I/O.....	1-12
	Relay Output.....	1-12
	Totalizer.....	1-12
	User Interface.....	1-13
	Operating a 2680 Series Data Acquisition System.....	1-14
	Isolated Networks.....	1-14
	General Networks.....	1-14
	Ethernet Port.....	1-14
	Group Operations.....	1-15
	Scanning and Logging.....	1-15
	RS-232 Interface.....	1-17

Host Computer Requirements	1-17
Options and Accessories	1-18
2 Preparing for Operation	2-1
Introduction	2-3
Instrument Preparation	2-4
Unpacking and Inspecting the Instrument	2-5
Positioning and Rack Mounting	2-5
Connecting to a Power Source and Grounding	2-5
Operating Using AC Power	2-6
Operating Using DC Power	2-7
Grounding and Common Mode Voltage	2-7
Alarm/Trigger I/O Connection	2-7
Trigger Input	2-8
Trigger Output	2-9
Master Alarm	2-10
External Trigger Wiring for a Group	2-10
Universal Input Module Analog Connections (2620A-180)	2-12
Shielded Wiring	2-15
Crosstalk Considerations	2-15
Digital I/O Connector Module	2-15
Digital I/O	2-16
Totalizer	2-16
Totalizer Enable	2-17
Relays	2-17
Controls and Indicators	2-17
Front Panel Controls	2-17
Front Panel Indicators	2-19
Rear Panel Controls	2-22
Rear Panel Indicators	2-23
Front Panel Operating Procedures	2-24
Power-On Options	2-24
Displaying a Monitor Channel	2-25
Displaying the Digital I/O Status	2-27
Displaying Relay Status	2-28
Displaying the Totalizer Status	2-30
Reviewing and Setting the Base Channel Number	2-31
Reviewing and Setting the Line Frequency	2-33
Reviewing and Setting the Network Type	2-35
Reviewing and Setting the General Network Socket Port	2-40
Reviewing and Setting the General Network IP Address	2-41
Reviewing and Setting the Subnet Mask and Default Gateway	2-42
Viewing the Instrument Ethernet Address	2-44
Reviewing and Setting PC Card Options	2-46

Host Computer and Network Preparation.....	2-47
Installing Host Computer Ethernet Adapter.....	2-47
Instrument and Host Computer Interconnection	2-49
Host Computer/Instrument Direct Connection	2-49
Interconnection Using 10/100BaseT (Twisted Pair) Ethernet Wiring..	2-50
Set Up Windows Networking	2-52
Setting Host Computer Networking Parameters	2-53
Installing Fluke DAQ Software.....	2-53
Testing and Troubleshooting	2-54
Installing and Testing the Installation	2-54
Troubleshooting Network Problems	2-58

3 Using Fluke DAQ Software 3-1

Introduction.....	3-3
Installing Fluke DAQ Software	3-4
Understanding the User Interface	3-5
Fluke DAQ Main Window	3-5
Using the Toolbar.....	3-6
Understanding the Workspace Area.....	3-8
Configuration Dialogs.....	3-9
Main Configuration Dialog.....	3-9
Instrument Configuration Dialog.....	3-9
Module Configuration Dialog.....	3-10
Analog Channel Configuration Dialog	3-10
DIO Configuration Dialog	3-10
Computed Channel Configuration Dialog	3-10
Communication Dialogs.....	3-11
Main Communication Dialog	3-11
Instrument Communication and Status Dialog.....	3-11
Module Communication Dialog	3-11
Digital I/O Points Dialog	3-11
Computed Channels Dialog	3-11
Communications Icons.....	3-12
Security Dialogs.....	3-12
Trend Dialog	3-13
Alarm Dialog.....	3-13
Mail and Web Settings Dialogs.....	3-13
Managing Your Network Using Fluke DAQ.....	3-14
Inserting and Configuring an Instrument	3-14
Inserting and Configuring a Module	3-19
Inserting and Configuring a Channel	3-23
Configuring a Computed Channel.....	3-26
Configuring Multiple Channels.....	3-29
Using Equations with Computed Channels.....	3-30

Starting a Scan	3-32
Starting a Configuration Scan	3-32
Starting an Instrument Scan.....	3-33
Getting Scan Data.....	3-33
Viewing and Resetting the Totalizer	3-34
PC Card Functions.....	3-34
Getting PC Card Information	3-34
Formatting the PC Card.....	3-34
Getting PC Card Scan Data	3-35
Starting Spy	3-36
Viewing Module Measurement Data.....	3-38
Using the Digital I/O Points Communication Dialog.....	3-39
Using Trend to View Collected Data.....	3-40
Changing the Trend Chart Display.....	3-43
Viewing Alarms.....	3-44
Configuring Data Files.....	3-46
Selecting a Master for a Data Group.....	3-47
Advanced Data File Configuration.....	3-47
Real-time Data File Creation	3-53
Main Window Advanced Settings.....	3-55
Using Fluke DAQ System Security Features	3-56
Configuring Web and Alarm Mail Settings	3-58
4 Maintenance	4-1
Introduction	4-3
Self-Test Diagnostics and Error Codes	4-3
Cleaning	4-6
AC Fuse Replacement.....	4-7
DC Fuse Replacement.....	4-9
Performance Test.....	4-9
Configuring the Performance Test Setup.....	4-9
Initializing the Performance Test Setup.....	4-11
Accuracy Performance Tests.....	4-13
Master Alarm Output Tests.....	4-14
RS-232 Master Alarm Output Test.....	4-14
Fluke DAQ Master Alarm Output Test	4-14
Trigger Input Tests	4-15
RS-232 Trigger Input Test.....	4-15
Fluke DAQ Trigger Input Test.....	4-15
Trigger Output Tests.....	4-15
RS-232 Trigger Output Test.....	4-15
Fluke DAQ Trigger Output Test	4-16
Volts DC Accuracy Test (PAI Module).....	4-16
Volts DC Accuracy Test (FAI Module).....	4-17

Volts AC Accuracy Test	4-18
Frequency Accuracy Test	4-19
Analog Channel Integrity Test	4-20
Open Thermocouple Response Test	4-20
2-Wire Resistance Accuracy Test (PAI) - Optional	4-21
2-Wire Resistance Accuracy Test (FAI Module) - Optional	4-22
4-Wire Resistance Accuracy Test (PAI Module)	4-24
4-Wire Resistance Accuracy Test (FAI Module)	4-28
Digital Input/Output Tests	4-29
RS-232 Digital Input/Output Test	4-29
Fluke DAQ Digital Input/Output Test	4-30
DIO Relay/Fuse Tests	4-30
RS-232 DIO Relay Fuse Test	4-30
Fluke DAQ DIO Relay Fuse Test	4-30
Totalizer Tests	4-31
RS-232 Totalizer Count Test	4-31
RS-232 Totalizer Count and Enable Test	4-31
RS-232 Totalizer Count and Direction Test	4-32
RS-232 Totalizer Count and Debounce Test	4-32
Fluke DAQ Totalizer Count Test	4-33
Fluke DAQ Totalizer Count and Enable Test	4-33
Fluke DAQ Totalizer Count and Direction Test	4-34
Fluke DAQ Totalizer Count and Debounce Test	4-34
Calibration	4-35
Variations in the Display	4-35
Service	4-36
Replacement Parts	4-36

Appendices

A Specifications	A-1
B Noise, Shielding, and Crosstalk Considerations	B-1
C True-RMS Measurements	C-1
D RTD Linearization	D-1
E Computed Channel Equations	E-1
F Data File Format	F-1
G Ethernet Cabling	G-1
H Network Considerations	H-1
I Error Codes	I-1

List of Tables

Table	Title	Page
1-1.	Channel Count vs Scan Rate.....	1-16
1-2.	Models, Options and Accessories.....	1-18
2-1.	Front Panel Key Descriptions.....	2-18
2-2.	Annunciator Display Descriptions.....	2-20
2-3.	Instrument Default Parameters.....	2-24
2-4.	Displaying a Monitor Channel.....	2-25
2-5.	Displaying the Digital I/O Status.....	2-27
2-6.	Displaying Relay Status.....	2-28
2-7.	Displaying Totalizer Status.....	2-30
2-8.	Reviewing and Setting the Base Channel Number.....	2-31
2-9.	Reviewing and Setting the Line Frequency.....	2-33
2-10.	Reviewing and Setting the Network Type.....	2-35
2-11.	Reviewing and Setting the Network Type to General.....	2-37
2-12.	Reviewing and Setting the General Network Socket Port.....	2-40
2-13.	Reviewing and Setting the General Network IP Address.....	2-41
2-14.	Reviewing and Setting the Subnet Mask and Default Gateway.....	2-43
2-15.	Viewing the Instrument Ethernet Address.....	2-44
2-16.	Identifying Network Problems.....	2-58
2-17.	Ethernet Indicators.....	2-61
3-2.	Configuration Control States.....	3-29
3-3.	File Renaming Example.....	3-51
3-4.	File Size Control Criteria.....	3-52
4-1.	Self-Test Codes.....	4-4
4-2.	Recommended Test Equipment.....	4-10
4-3.	Replacement Parts.....	4-36
A-1.	2680 Series General Specifications.....	A-2
A-2.	2680A/2686A Clock and Calendar.....	A-3
A-3.	Trigger In Specification.....	A-4
A-4.	Trigger Out Specification.....	A-4
A-5.	Master Alarm Output Specification.....	A-5
A-6.	2686A - Active Channels and Number of Scans to Card Capacity.....	A-5

A-7.	PAI Module DC Voltage General Specifications.....	A-6
A-8.	PAI Module DC Voltage Range and Resolution Specifications.....	A-7
A-9.	PAI Module DC Voltage Accuracy Specifications.....	A-7
A-10.	PAI Module AC Voltage General Specifications.....	A-8
A-11.	PAI Module AC Voltage Range and Resolution Specifications.....	A-9
A-12.	PAI Module AC Voltage Accuracy Specifications.....	A-10
A-13.	PAI Module 4-Wire Resistance Temperature Coefficient.....	A-11
A-14.	PAI Module 4-Wire Resistance Range and Resolution Specifications.....	A-11
A-15.	PAI Module 4-Wire Resistance Accuracy Specifications.....	A-12
A-16.	PAI Module 4-Wire RTD Temperature Coefficient.....	A-13
A-17.	PAI Module 4-Wire RTD Specifications.....	A-13
A-18.	PAI Module Thermocouple General Specifications.....	A-14
A-19.	PAI Module Thermocouple Specifications.....	A-15
A-20.	PAI Module Frequency Accuracy Specifications.....	A-17
A-21.	PAI Module Frequency Sensitivity Specifications.....	A-17
A-22.	FAI Module DC Voltage General Specifications.....	A-18
A-23.	FAI Module DC Voltage Resolution and Repeatability Specifications.....	A-19
A-24.	FAI Module DC Voltage Accuracy Specifications.....	A-19
A-25.	FAI Module AC Voltage General Specifications.....	A-20
A-26.	FAI Module AC Voltage Range and Resolution Specifications.....	A-20
A-27.	FAI Module AC Voltage Accuracy Specifications.....	A-21
A-28.	FAI Module 4-Wire Resistance Temperature Coefficient.....	A-22
A-29.	FAI Module 4r-Wire Resistance Range and Resolution Specifications.....	A-22
A-30.	FAI Module 4-Wire Resistance Accuracy Specifications.....	A-23
A-31.	FAI Module 4-Wire RTD Temperature Coefficient.....	A-23
A-32.	FAI Module 4-Wire RTD Specifications.....	A-24
A-33.	FAI Module Thermocouple General Specifications.....	A-24
A-35.	FAI Module Frequency Accuracy Specifications.....	A-27
A-36.	FAI Module Frequency Sensitivity Specifications.....	A-27
A-37.	DIGITAL I/O Specification.....	A-28
A-38.	Totalizer Specification.....	A-29
A-39.	DIGITAL I/O Relay Specification.....	A-29
B-1.	FAI Module Crosstalk Specifications.....	B-3
B-2.	PAI Module Crosstalk Specifications.....	B-4
I-1.	Error Codes.....	I-1

List of Figures

Figure	Title	Page
1-1.	2680A/2686A Instrument	1-4
1-2.	2680A/2686A Front Panel	1-5
1-3.	Typical Front Panel Display During Scanning and Monitoring	1-6
1-4.	2680A/2686A Rear Panel	1-7
1-5.	DIO Connector Module	1-13
2-1.	Instrument Preparation.....	2-4
2-2.	Connecting the Instrument to a Power Source.....	2-6
2-3.	Alarm/Trigger I/O Connector	2-9
2-4.	External Trigger Wiring for a Group of Instruments.....	2-11
2-5.	Universal Input Module Connections	2-13
2-6.	2-Wire and 4-Wire Connections	2-14
2-7.	Digital I/O Connector	2-16
2-8.	Front Panel Controls	2-17
2-9.	Front Panel Indicators.....	2-19
2-10.	Rear Panel Controls	2-22
2-11.	Displaying a Monitor Channel.....	2-26
2-12.	Examples During Monitor	2-26
2-13.	Examples for Digital I/O, Relay, and Totalizer Status	2-29
2-13.	Reviewing and Setting the Base Channel Number	2-32
2-14.	Examples for Reviewing and Setting the BCN.....	2-32
2-14.	Reviewing and Setting the Line Frequency	2-34
2-15.	Examples for Reviewing and Setting the Line Frequency.....	2-34
2-15.	Reviewing and Setting the Isolated Network Type to Isolated.....	2-36
2-16.	Examples for Reviewing and Setting the Network Type.....	2-36
2-17.	Examples for Reviewing and Setting General Network Parameters	2-38
2-17.	Viewing the Instrument Ethernet Address.....	2-45
2-18.	Examples for Viewing the Ethernet Address.....	2-45
2-19.	Preparing for Network Operation	2-48
2-20.	Host Computer/Instrument Direct Connection	2-49
2-21.	Interconnection Using 10/100BaseT (Twisted Pair) Wiring	2-51
4-1.	Replacing the Fuse.....	4-8

4-2.	Performance Test Setup	4-11
4-3.	2-Wire Connections to 5700A.....	4-24
4-4.	4-Wire Connections to the Universal Input Module (Resistor).....	4-25
4-5.	4-Wire Connections to the Universal Input Module (5700A).....	4-26
A-1.	2680 Series Chassis	A-30
C-1.	Comparison of Common Waveforms.....	C-3
D-1.	385 RTD.....	D-2
D-2.	375 RTD.....	D-3
D-3.	391 RTD.....	D-4
D-4.	392 RTD.....	D-6
G-1.	10/100BaseT Ethernet Cables	G-2

Chapter 1 Overview

Contents	Page
Introduction	1-3
Contacting Fluke	1-3
Instrument Features and Capabilities	1-5
Mainframe Features	1-8
Trigger Input.....	1-8
Trigger Output.....	1-8
PC Card ATA Interface (2686A Only).....	1-8
Master Alarm.....	1-9
Interval Trigger.....	1-9
External Trigger.....	1-9
Alarms	1-9
Channel Monitoring.....	1-10
Alarm Trigger.....	1-10
Channel Numbering.....	1-10
Computed Channels.....	1-11
Mx+B Scaling.....	1-11
Analog Channels.....	1-11
Digital I/O Module Option.....	1-12
Digital I/O.....	1-12
Relay Output.....	1-12
Totalizer.....	1-12
User Interface	1-13
Operating a 2680 Series Data Acquisition System.....	1-14
Isolated Networks	1-14
General Networks	1-14
Ethernet Port	1-14
Group Operations.....	1-15
Scanning and Logging	1-15
RS-232 Interface.....	1-17
Host Computer Requirements	1-17
Options and Accessories	1-18

Introduction

The 2680A Data Acquisition System (DAS) and 2686A Data Logging System (DLS) provide 20 to 120 channels that operate in conjunction with Fluke DAQ software for Windows to form a data acquisition system.

The 2686A comes with a removable PC Card (PCMCIA) for stand-alone storage operation. This socket accepts ATA memory cards up to 2 GB in size.

Each 2680 Series instrument can hold from 1 to 6 modules. These modules are the Precision Analog module (PAI), Fast Analog module (FAI), and the Digital IO/Relay and Totalizer module (DIO). These modules are all isolated from one another. You can add the DIO module to the instrument in slot 6 only.

The analog modules measure dc volts, ac volts, ohms, temperature, frequency, and dc current. Temperature measurements use thermocouples, thermistors or resistance temperature detectors (RTDs). The instruments also have extensive computed math capability. Besides using data collected from the analog modules and digital totalizer, time can also be used in computed channel calculations.

The system scans 20 to 120 analog channels and calculates the values for up to 60 computed channels. Interval timers, alarm conditions, and/or an external signal input can trigger scans. The Fluke DAQ software configures and controls up to 99 2680 Series instruments via an Ethernet connection. The software provides the means to view scan data and log it into files. In addition, Fluke DAQ software permits multiple master/slave groups to run simultaneously.

The two analog modules that may be used with the 2680 Series are the FAI module and the PAI module. The PAI modules emphasize precision with 5 ½ digits of resolution, .02% accuracy, and can withstand up to 150 V common mode voltage (300 V on channels 1 and 11). The FAI modules emphasize increased measurement speed with 4 ½ digits of resolution, 0.04% accuracy, and can withstand up to 50 V common mode voltage. See Appendix A for instrument specifications.

Contacting Fluke

To contact Fluke, call one of the following telephone numbers:

USA: 1-888-99-FLUKE (1-888-993-5853)

Canada: 1-800-36-FLUKE (1-800-363-5853)

Europe: +31 402-675-200

Japan: +81-3-3434-0181

Singapore: +65-738-5655

Anywhere in the world: +1-425-446-5500

Or, visit Fluke's Web site at www.fluke.com.

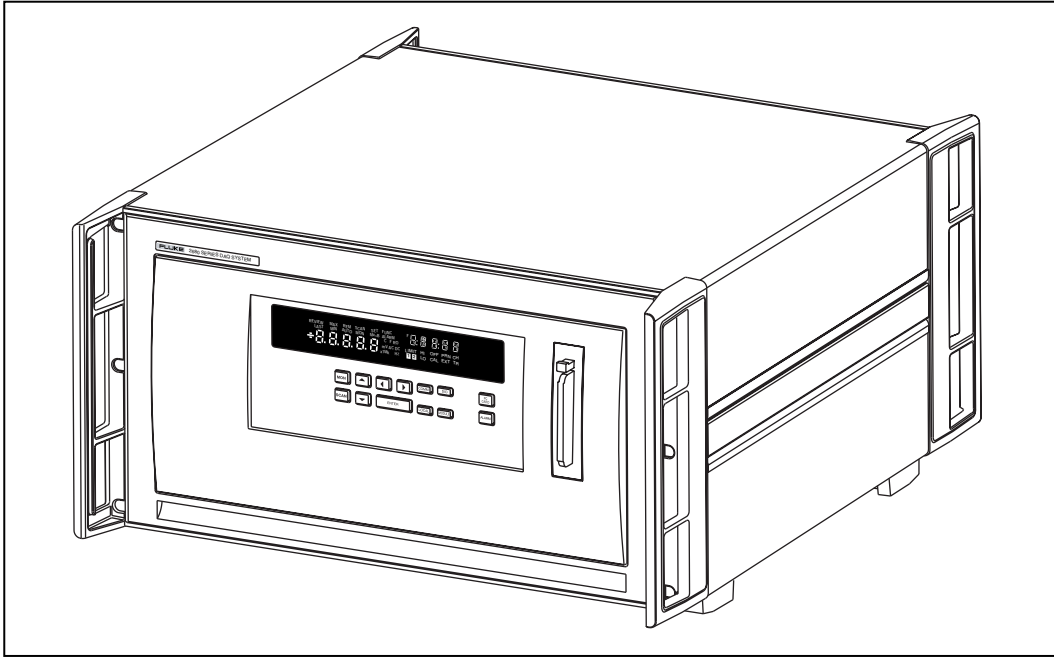

Figure 1-1. 2680A/2686A Instrument

alg46f.eps

Instrument Features and Capabilities

The following describes the front and rear panels of the instrument and its capabilities (Figures 1-2 to 1-4).

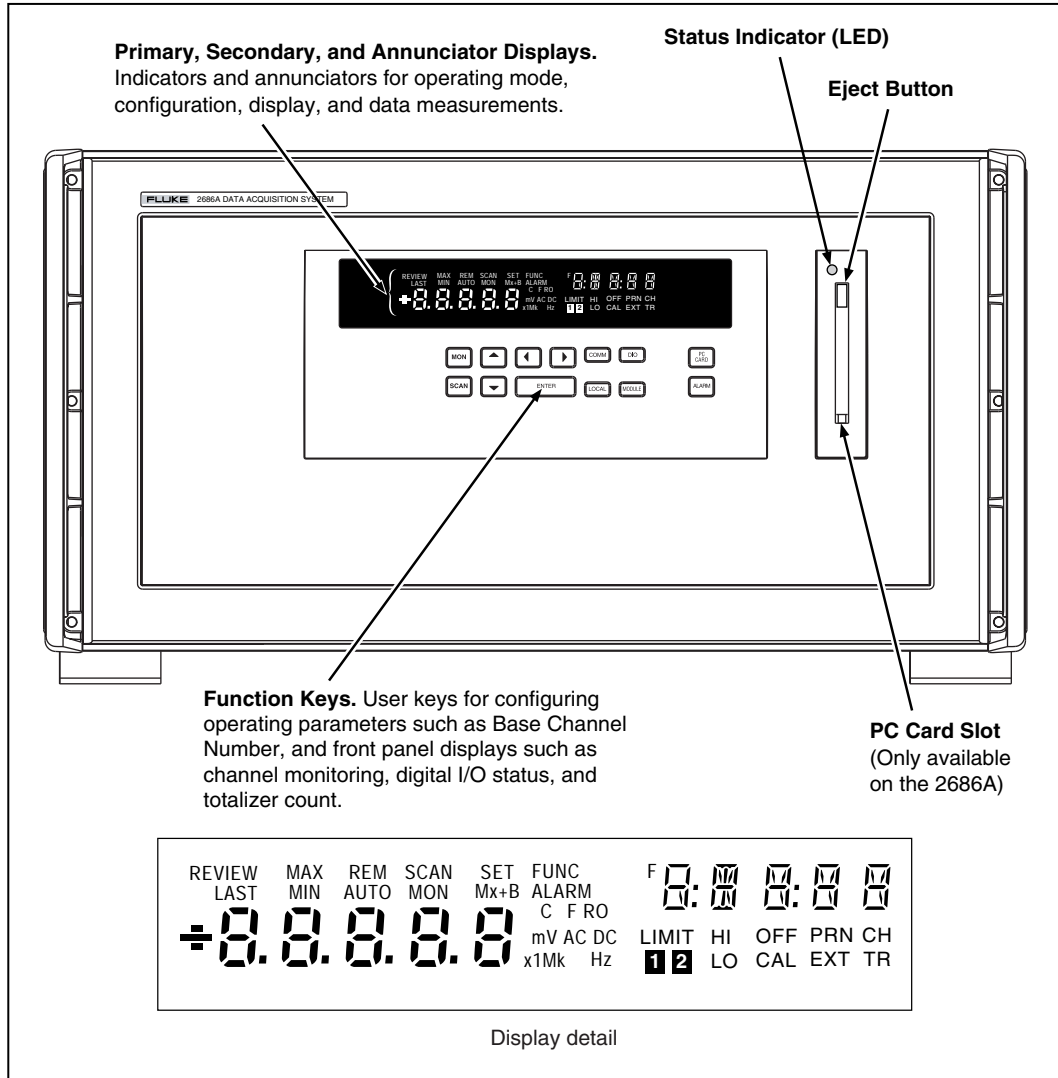
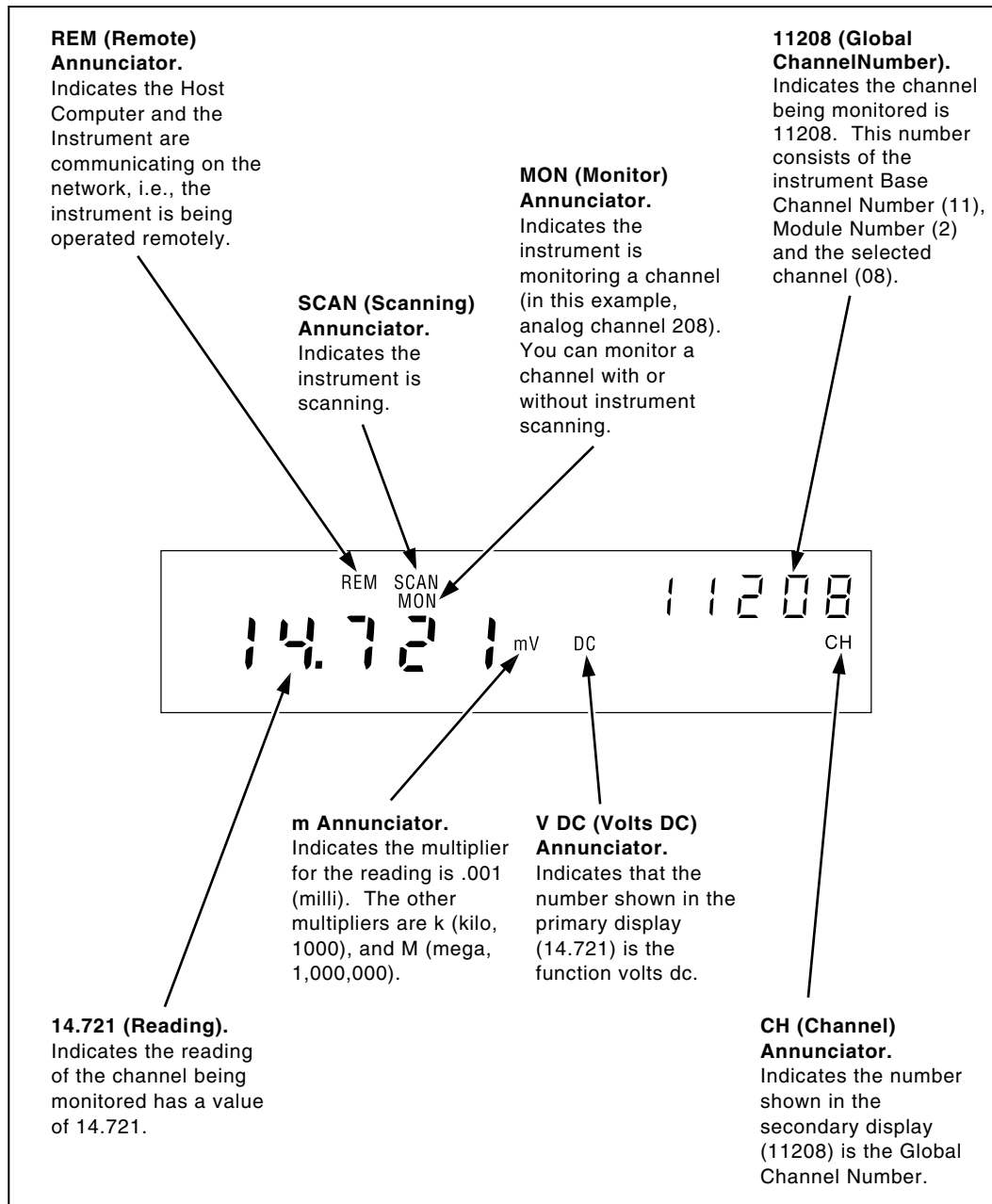

Figure 1-2. 2680A/2686A Front Panel

alg47f.eps



alg48f.eps

Figure 1-3. Typical Front Panel Display During Scanning and Monitoring

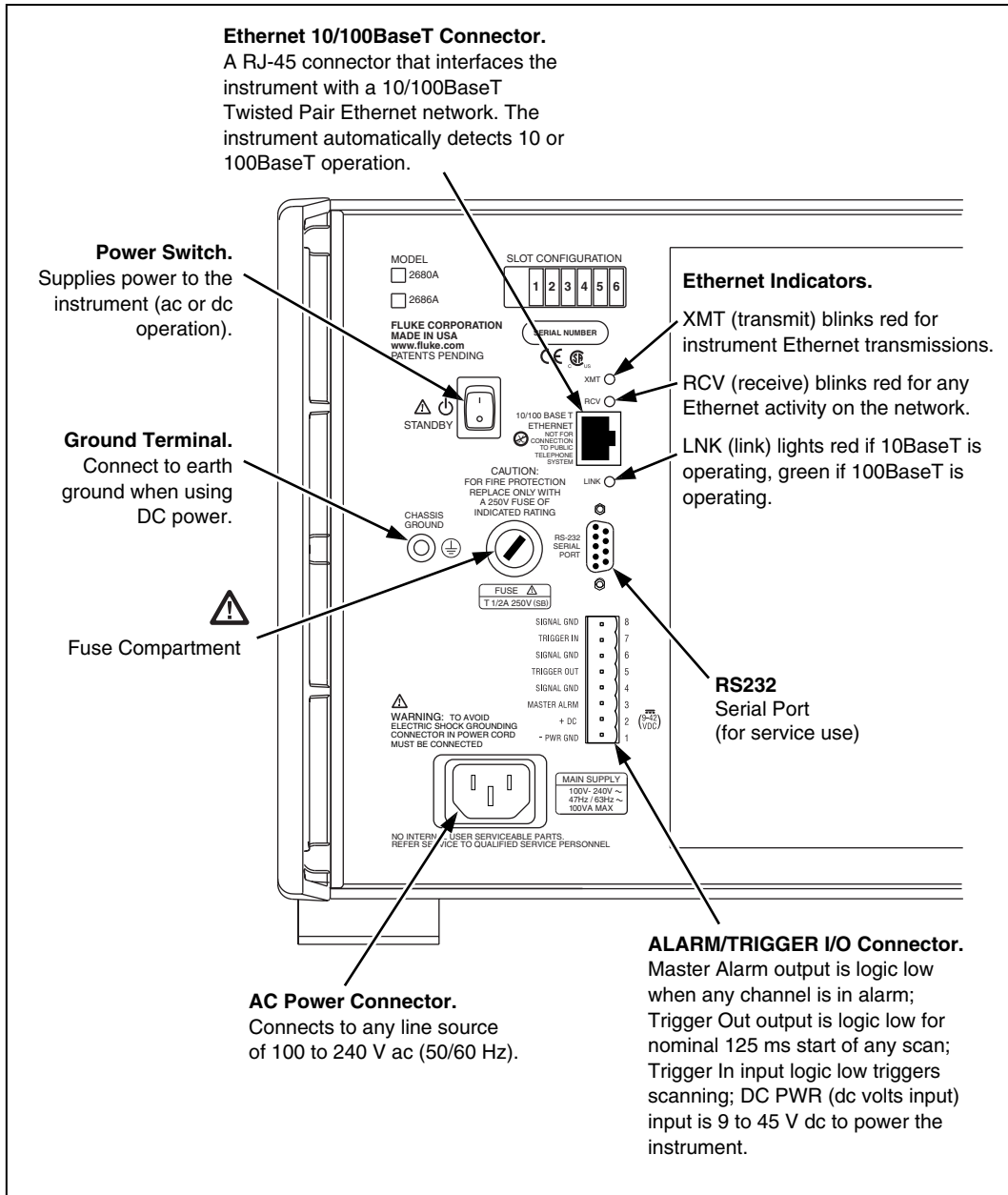

Figure 1-4. 2680A/2686A Rear Panel

aig60f.eps

Mainframe Features

Trigger Input

Trigger Input is an instrument connection used to trigger scans from an external source. The connection uses the rear panel Trigger In and GND (Figure 1-4). A logic low or contact closure between Trigger In and GND triggers an instrument scan if External Trigger is enabled. While the trigger input line is held low, the instrument continues to scan at Interval 2.

When there is no trigger input, an internal pull-up resistor holds the input at logic high (nominal +5.0 V dc).

Trigger Output

Trigger Output is an output line that, when enabled, goes to logic low for 125 μ s every time a scan begins. The connection uses the rear panel Trigger Out and GND (Figure 1-4). Use the Trigger Output to trigger other instruments by their Trigger Input connection and to interface with external equipment. An internal pull-up resistor holds the trigger output line at a logic high (nominal +5.0 V dc) when there is no trigger output.

PC Card ATA Interface (2686A Only)

A PC ATA card interface provided in each 2686A system. It can be used to store data when there is no network connection. The data produced is DOS compatible. When scanned data is first recorded on the card, a copy of the configuration of the instrument is also recorded. As a result, you can stop scanning, remove the card, read results, reinstall the card in the same instrument, and restart scanning and have only one file created. If you want to clear the existing memory card, the front panel keys can be used to erase the card contents. You can use up to 2 GB ATA compatible PC Card in a 2686A instrument. See Chapter 2 for additional information.

An error will result if a card has partially been filled with data from a different configuration. This can be fixed by using the front panel keys to erase the existing data in the card.

⚠⚠ Caution

Removing the PC card while the storage LED is on may cause a loss of data. Before removing the card, stop the instrument scanning. Loss of power while data is being written to the card may also result in loss of data.

Master Alarm

Master Alarm is an instrument output line that is logic low (nominal +0.8 V dc) for as long as any channel is in alarm while scanning is active. The connection uses the ALARM/TRIGGER I/O terminals Master Alarm and GND (Figure 1-4). This TTL output interfaces with external equipment such as warning lights, alarms, automatic shutdowns, and paging systems. When the alarm condition ends or scanning stops, an internal pull-up resistor sets the output at logic high (nominal +5.0 V dc).

Interval Trigger

Interval Trigger is an internal software timer you can set using Fluke DAQ software. It permits scanning at regular time intervals using Interval 1. Interval 1 is in seconds, with a minimum of 0.000 (continuous scanning) and a maximum of 86400.000 (one scan every 24 hours). The time resolution is to the millisecond, for example, 12.345 seconds.

External Trigger

External Trigger is started by an external event and triggers scanning when an external logic low is applied to the instrument Trigger In line. As long as the Trigger Input remains low, scans are triggered at regular time intervals using Interval 2. Interval 2 is in seconds, with a minimum of 0.000 (continuous scanning) and a maximum of 86400.000 (one scan every 24 hours). The time resolution is to the millisecond, for example, 12.345 seconds. When scanning starts, if the External Trigger is logic low, scanning begins at the Interval 2 rate. If the External Trigger is logic high, no scans are triggered until the trigger line is set to logic low.

If one or more external trigger events occur while a scan is in progress, one triggered scan follows the scan in progress.

Alarms

Two alarms, Alarm 1 and Alarm 2, can be applied to any configured channel. An alarm condition occurs when a measurement falls below a low alarm value, rises above a high alarm value, or is between the two alarm values. If you apply $Mx+B$ scaling as part of the channel configuration, the instrument bases the alarms on the scaled values.

When any configured channel is in alarm, the Alarm annunciator is on dim, or bright if a channel in alarm is being used as an Alarm Trigger. When a channel is in alarm, the rear-panel Master Alarm output is asserted (logic low). You can use alarms to trigger scanning (see Alarm Trigger later in this chapter) and to set a Digital I/O line to a logic low (see Digital I/O Module later in this chapter) or close a relay. The Fluke DAQ software displays and records alarm conditions.

Channel Monitoring

Channel monitoring takes place at the front panel of the instrument. Use the front panel MON key and arrow keys to select a channel for monitoring. The Fluke DAQ software also allows the selection of a channel to monitor during scanning. For an example of a front panel display of the instrument during monitoring, see Figure 1-3. Monitor can also automatically scroll up or down through the channels displaying each channel and then moving to the next. The channel monitoring display nominally updates once per second.

Alarm Trigger

The alarm trigger triggers scanning when a channel designated as an alarm trigger goes into alarm. As long as any such channel is in alarm, scans are triggered at regular time intervals using Interval 2. Interval 2 is in seconds, with a minimum of 0.000 (continuous scanning) and a maximum of 86400.000 (one scan every 24 hours). The time resolution is to the millisecond, for example, 12.345 seconds.

The instrument performs background monitoring of channels designated as alarm triggers to check for alarm conditions using Interval 3.

You can combine Alarm Trigger with External Trigger and Interval Trigger. For example, set the Interval Trigger for 60 seconds (Interval 1) and the Alarm Trigger for 10 seconds (Interval 2). Scanning is at 60 second intervals except when a channel designated as an alarm trigger is in alarm, when scanning is at 10 second intervals.

Channel Numbering

Each instrument channel, measured or computed, is identified by the Global Channel Number (GCN). The first two digits of the GCN are the Base Channel Number (01 to 99) that identifies the instrument. The third digit indicates the slot or module number. The last two digits are the channel number. For example, GCN 28318 indicates instrument 28, slot 3, and channel 18. When the instrument is in the quiescent state, the channel number of the GCN shows dashes, for example, 45--- for instrument 45.

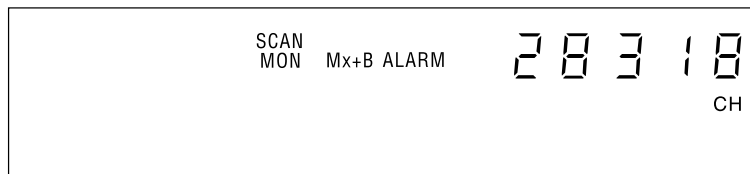

Computed Channels

In addition to the analog channels, the instrument provides an additional 60 computed channels by processing analog channels and other computed channels.

The computed channels are numbered 901 to 960. The following calculations are used:

- The average of a group of channels,
- The difference between any two channels,
- The difference between a channel and the average of a group of channels,
- A mathematical equation. Other channels, time and totalizer can be part of the equation.

For computed channels, the functions use 24 bits and an exponent for calculations. As a result, when the totalizer or time exceed 16,777,215 units, the number will be rounded off to remain within the 24 bits. For example, one count more than 16,777,215 would be rounded to 16,777,220 in a computed channel.

Mx+B Scaling

Mx+B scaling multiplies a measurement by a multiplier M and then offsets it by an offset B. For example, Mx+B scaling of $100x+50$ applied to a measured or computed channel value of 1.15 results in a reading of $100(1.15)+50=165$. A common use of Mx+B scaling is to scale a sensor or transducer to provide for display and recording in engineering units. The Mx+B annunciator lights when a monitored channel has scaling applied.

Analog Channels

The analog channel measurement connections are made via the Universal Input Modules. External signal conditioning for the analog inputs is not necessary for most common electrical signals. The input channels are numbered 101 to 120, 201 to 220, 301 to 320, 401 to 420, 501 to 520, and 601 to 620. The host computer configures all analog channels using the Fluke DAQ software.

There are two different analog modules available for the 2680 Series instruments with up to 6 modules for any given instrument. Each module is isolated from every other module to 300 V. One analog module is the fast analog module (FAI) and has a maximum rate of 667 channel readings per second but a limited input voltage of 50 V dc or 30 V rms. The other analog module is the precision analog module (PAI). The PAI has a maximum of 300 V dc rms (on channel 1 and 11) and a maximum rate of 133 channel readings per second. All other channels are 150 V maximum for the PAI module. The Digital IO/Relay and Totalizer module can monitor digital type (High or Low) signals.

Digital I/O Module Option

Digital I/O

20 general-purpose open collector digital outputs and Transistor Logic (TTL) digital input lines are available in the Digital I/O module. A logic low can be applied to an I/O line as an input; alternatively a logic low can be internally set by the instrument if the channel is set as an output. If no logic low is set or applied externally, the input is pulled up to logic high (+5 V) internally. An output logic low condition takes precedence over an input logic high condition. When the I/O lines are used as inputs, they signal an external condition that can be correlated to the data measurements.

Fluke DAQ software records the status of the Digital I/O as the decimal equivalent of the 20 binary bits. For example, 1111 1111 1111 1111 1111 (DIO19 to DIO0) is represented by decimal 1,048,575; 0000 0000 0000 0000 1111 is represented by decimal 15.

The instrument can display the Digital I/O status in binary format at the front panel with updates each second.

Relay Output

There are also 8 relays capable of switching up to 1 A or 250 V rms. Fluke DAQ software records the relay status as bits 24-31 of the DIO value. The relay status can also be displayed on the instrument front panel.

Totalizer

The Digital I/O module also includes a totalizer with external enable. The totalizer input counts contact closures or voltage transitions with a maximum count of 4,294,967,295. There is also an external totalizer enable that can be used to enable the totalizer. The totalizer can be preset and count down to zero or count up from zero.

The connections for the totalizer are the Σ and Σ_{en} input lines on the Digital I/O connector (Figure 1-5). The instrument continuously detects the totalizer input on the rear panel independently from instrument scanning and other activities. If the Totalizer overflows (reaching the maximum count), the display briefly shows OL (overload) and begins counting again.

A totalizer input from contact closures increments on the “open” portion of the switch sequence close-open. To prevent switch contact “bounce” from triggering false readings, select the Totalizer Debounce feature. A totalizer input from voltage transitions increments during low-to-high voltage transitions with a nominal threshold of +1.4 V. The maximum voltage input is +30 V dc, and the minimum voltage input is -4.0 V dc. The maximum totalizer rate is 5,000 transitions per second without debounce and 500 transitions per second with debounce.

The instrument reports totalizer status with scan data and can display it at the front panel. You can initialize the totalizer count by cycling power to the instrument or using Fluke DAQ software.

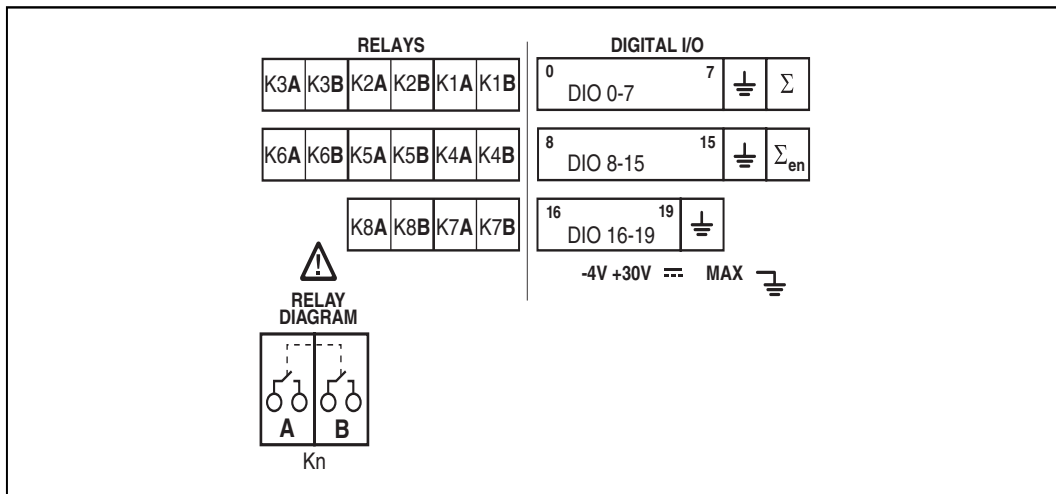

Figure 1-5. DIO Connector Module

alg57f.eps

User Interface

Fluke DAQ is the operating software for the 2680 Series instruments. It lets you configure and operate your system through a Windows-based environment. You can install Fluke DAQ on either Windows XP, 2000 (Service Pack 3 required), or NT (Service Pack 6.0 required). Chapter 3 of this manual provides detailed information about using Fluke DAQ software.

You can use Fluke DAQ software to easily perform the following:

- Configure your 2680 Series network and instrument settings.
- Download/upload configuration to the instruments.
- Send commands to the digital I/O.

- Monitor the instruments on-line values and alarms.
- Plot trend charts, retrieve historical trends, acknowledge alarms, and export data files in .csv format.

Note

Fluke DAQ supports the NetDAQ 2680 models (2640A and 2645A) as well as the 2680A and 2686A.

Operating a 2680 Series Data Acquisition System

You can configure 2680 Series instruments to operate over either an isolated or general network. An isolated network includes 2680 Series instruments and a host computer only. A general network may also include servers, routers, gateways, or other network devices. Both types of networks interconnect using Ethernet (i.e., using the IEEE 802.3 or ISO 8802-3 standards).

A unique 2 digit Base Channel Number (BCN) entered at the instrument front panel identifies each 2680 Series instrument on the network. All subsequent operations refer to the instrument by BCN. Fluke DAQ supports up to 99 instruments for operation. You cannot operate an instrument from more than one host computer at a time.

Isolated Networks

An isolated network consists of only 2680 Series instruments and host computer. The advantages include simplified setup, faster network operation, and freedom from general network problems. Data throughput specifications are guaranteed only for isolated networks. When you set Fluke DAQ software for an isolated network, it automatically handles instrument IP addressing. You must configure your host computer networking software to use a host computer IP address of 198.178.246.101 and subnet mask of 255.255.255.0. See Setting Host Computer Network Parameters in Chapter 2 of this manual.

General Networks

A general network consists of host computers, 2680 Series instruments, and servers, routers, gateways, or other network devices. Refer connectivity issues to your network administrator and review Network Considerations in Appendix H for more information. When you install the software for a general network, you must enter the instrument IP addresses manually. For more information, see Reviewing and Setting the Network Type in Chapter 2.

Ethernet Port

Each 2680 Series instrument has a 10/100BaseT twisted pair Ethernet network port. The instrument automatically monitors the Ethernet port.

Group Operations

Using Fluke DAQ, you can group scan data from multiple instrument modules and sources. Fluke DAQ can record data from all sources in the group into a single .csv data file.

When grouping data, one module or instrument is designated as the Master. The Master determines the times of the scans in the .csv data file. Scan data can be grouped while scanning, or after scanning has ended using the Export feature.

Scanning and Logging

When a scan is triggered, the instrument scans the 20-120 analog channels, scans the Digital I/O channels and totalizer and calculates the 60 computed channels. It stores the resulting time-stamped data in a scan record. Scans can be triggered from several sources:

- Interval Trigger, where an elapsed interval timer triggers a scan.
- External Trigger, where an external input (ground or logic low) applied to the instrument, the Trigger In signal triggers a scan.
- Alarm Trigger, where a channel going into alarm starts a scan.

Fluke DAQ software obtains scan records from the instruments and logs the data into a history database and optionally into a .csv file. Each scan record consists of a timestamp, values from all configured and recording analog channels and computed channels, and the alarm states, plus the Digital I/O line status and the count of the totalizer if the Digital I/O Relay module is in the instrument.

A number of factors can affect the actual scan rate in the 2680A/2686A instruments. These include:

- The number of active modules
- The number of active channels
- Use of the DIO for alarms or as a totalizer/counter
- Writing to a PC card
- Network data rates.

There is a 2.6 ms overhead associated with accessing each module in a instrument. There is overhead associated with reading each channel. For an FAI module, it is about 1.4 ms per channel. Consequently, including the module overhead, when reading one FAI with 20 active channels, you can get the scanned data in 30 ms or 667 channels per second. If you read only one channel, it takes 4 ms for a rate of only 250 channels per second. For high-speed measurements, it is faster to use fewer channels on each module. However, when a single channel and minimum scan interval are used on four or more FAIs, the internal program may not keep up with the scan data rate and some data could be lost.

The internal evaluation algorithm allows data from slower modules to be recorded regardless of the scan speed of other modules. The measurements made by slower PAIs will still be recorded even when running in a chassis of FAIs. Only the fastest modules may experience some loss of data. If the user sets the interval time of each module to 31 ms or greater, no data will be lost for any number of FAI channels. In addition, if the total number of scans for all of the modules combined is less than 1000 scans per second, there should be no problem with losing scans. Below is a table showing the timing.

Using the DIO for alarms or the totalizer will slow system throughput because of its 4 ms overhead. DIO data is provided with each module scan. Consequently, having five modules scanning at the same speed will incur an additional 20 ms delay if a DIO is active.

Writing to the PC card is more time consuming than writing to internal memory. This is partly because the 2686A instrument uses a DOS compatible file storage system that requires additional overhead. As a result, the maximum scan time while storing data will be slowed.

Table 1-1. Channel Count vs Scan Rate

2680A/2686A Channel Rate With No Lost Data*			
Channel Count	Module Count	Typical Total Time (ms)	Typical Scan Rate (ch/s)
1	1	4	250
1	2	4	500
1	3	4	750
1	4	4	1,000
1	5	5	1,000
1	6	6	1,000
20	1	30	666
40	2	30.1	1,329
60	3	30.1	1,993
80	4	30.1	2,658
100	5	30.1	3,322
120	6	30.1	3,990

* Assumes no DIO, no PC card storage, no network communication, and only FAI modules in the chassis.

Network traffic can have a significant impact on instrument throughput. More importantly, if the 2680 Series instruments cannot output the readings quickly enough, the internal memory will eventually overflow. Depending on the setting the user chose, the readings will either be written to the last location in memory or start to write over the oldest data location (the default). In either case, data can be lost.

The internal buffer memory can store up to 30,000 scans. A scan can contain up to 20 channels from one module plus up to 60 computed channels. At the fastest measurement rates, 6 FAI modules could fill up the internal memory in about 150 seconds. Once the internal memory is full, data will be lost.

RS-232 Interface

The instruments include an RS-232 port for calibration, servicing, and factory procedures; the RS-232 port is not used for instrument control or scan data collection. See Calibration in Chapter 4 of this manual.

Host Computer Requirements

The host computer used for instrument operations must meet the following minimum requirements:

- PC with a 200 MHz microprocessor or greater, running Windows XP, 2000 (Service Pack 3 required), or NT (Service Pack 6.0 required)
- Color VGA Monitor
- 200 MB of free disk space
- CD ROM drive

Options and Accessories

Table 1-2 summarizes the available models, options and accessories.

Table 1-2. Models, Options and Accessories

Model	Description
2680A-FAI	Fast Analog Input Module
2680A-PAI	Precision Analog Input Module
2680A-DIO	Digital I/O Relay with Totalizer Module
2680A-102	Extra Digital Connector Module
2680A-180	Extra Input Module for analog input procedures
2680A-800	16 MB Memory Card
2680A-801	128 MB Memory Card
2680A-802	256 MB Memory Card
2680A-805	512 MB Memory Card
2680A-810	1 GB Memory Card
2680A-BLANK	Blank Module
2680A-APSW	Fluke DAQ Software. Included with the purchase of each chassis.
2680A-DEVSW	Fluke Development Software
2680A-DLL	Fluke DLL Library routines for the development of custom user software.
2680A-OPC	Fluke OPC Software. Used to configure a PC to act as an OPC server and provide virtual contact with a 2680 Series instrument.

Chapter 2

Preparing for Operation

Contents	Page
Introduction	2-3
Instrument Preparation.....	2-4
Unpacking and Inspecting the Instrument.....	2-5
Positioning and Rack Mounting.....	2-5
Connecting to a Power Source and Grounding.....	2-5
Operating Using AC Power.....	2-6
Operating Using DC Power.....	2-7
Grounding and Common Mode Voltage.....	2-7
Alarm/Trigger I/O Connection.....	2-7
Trigger Input.....	2-8
Trigger Output.....	2-9
Master Alarm.....	2-10
External Trigger Wiring for a Group.....	2-10
Universal Input Module Analog Connections (2620A-180).....	2-12
Shielded Wiring.....	2-15
Crosstalk Considerations.....	2-15
Digital I/O Connector Module.....	2-15
Digital I/O.....	2-16
Totalizer.....	2-16
Totalizer Enable.....	2-17
Relays.....	2-17
Controls and Indicators.....	2-17
Front Panel Controls.....	2-17
Front Panel Indicators.....	2-19
Rear Panel Controls.....	2-22
Rear Panel Indicators.....	2-23
Front Panel Operating Procedures.....	2-24
Power-On Options.....	2-24
Displaying a Monitor Channel.....	2-25
Displaying the Digital I/O Status.....	2-27
Displaying Relay Status.....	2-28
Displaying the Totalizer Status.....	2-30

Reviewing and Setting the Base Channel Number.....	2-31
Reviewing and Setting the Line Frequency.....	2-33
Reviewing and Setting the Network Type.....	2-35
Reviewing and Setting the General Network Socket Port.....	2-40
Reviewing and Setting the General Network IP Address.....	2-41
Reviewing and Setting the Subnet Mask and Default Gateway.....	2-42
Viewing the Instrument Ethernet Address.....	2-44
Reviewing and Setting PC Card Options.....	2-46
Host Computer and Network Preparation.....	2-47
Installing Host Computer Ethernet Adapter.....	2-47
Instrument and Host Computer Interconnection.....	2-49
Host Computer/Instrument Direct Connection.....	2-49
Interconnection Using 10/100BaseT (Twisted Pair) Ethernet Wiring.....	2-50
Set Up Windows Networking.....	2-52
Setting Host Computer Networking Parameters.....	2-53
Installing Fluke DAQ Software.....	2-53
Testing and Troubleshooting.....	2-54
Installing and Testing the Installation.....	2-54
Troubleshooting Network Problems.....	2-58

Introduction

This chapter describes how to prepare the instrument, host computers and network for operation, and how to test and troubleshoot system operation.

Setting up your system requires the following steps (described in detail later in this chapter), performed in the order shown:

- **Instrument Preparation** Unpacking and setting up the 2680 Series instruments. This section of the manual describes all the connections, controls, and indicators on the instrument.
- **Host Computer Ethernet Adapter Installation** Installing an Ethernet adapter such as the 3COM Fast Etherlink 10/100 BaseTx interface card if your host computer does not already have one.
- **Instrument and Host Computer Interconnection** Connecting the host computer(s) and instruments.
- **Host Computer Software Installation** Installing Fluke DAQ software and networking software.
- **Testing and Troubleshooting** Testing and verifying network operation, and troubleshooting any difficulties.

Instrument Preparation

This section contains information for preparing the instrument for operation summarized in Figure 2-1.

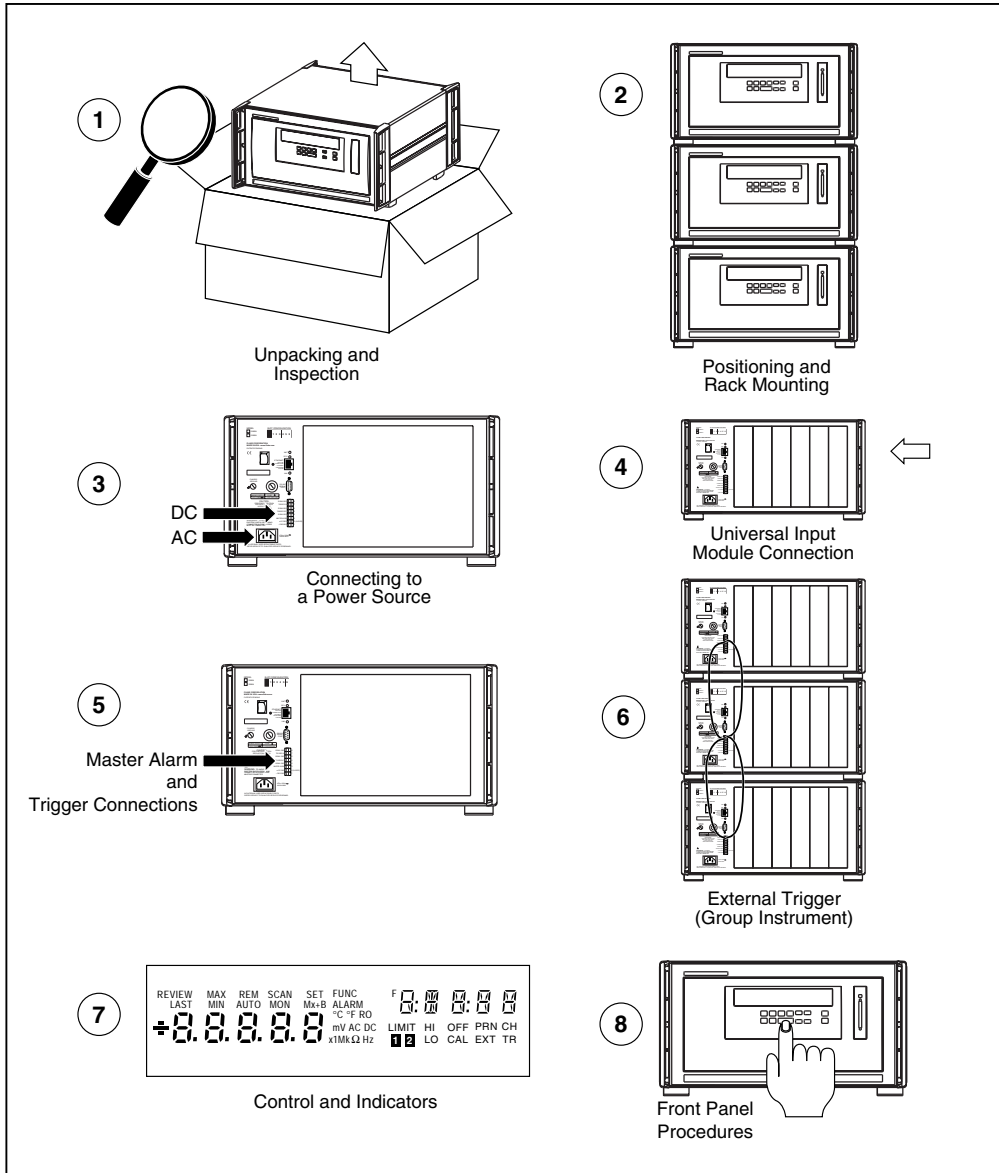

Figure 2-1. Instrument Preparation

alg05f.eps

Unpacking and Inspecting the Instrument

Verify the contents of the shipping package against the shipping label located on the outside of the shipping package. If any items are missing or damaged, report the problem immediately to your Fluke representative.

Carefully remove the instrument from its shipping container, saving the packaging materials if possible.

Positioning and Rack Mounting

Position the instrument in any location that meets the environmental specifications. (Refer to Appendix A.) The Rack Mounting Kit for the 2680 Series, model Y2680, (Part Number 1777577) includes hardware and instructions for mounting the instrument.

Connecting to a Power Source and Grounding

You can connect the instrument to an ac power source between 100 – 240 V ac (50/60 Hz), to a dc power source between 9 and 45 V dc, or to both. Fluke guarantees equipment specifications only for 50 Hz and 60 Hz mains operation and dc operation. Refer to Figure 2-2 and the descriptions below for making power connections. If you connect both ac power and dc power to the instrument, the instrument uses ac power when it exceeds approximately 8 times the value of the dc voltage. Automatic switchover occurs between ac and dc power without interrupting instrument operation.

If you connect both ac and dc power to the instrument, the ac and dc ground connections must be to the same earth ground terminal.

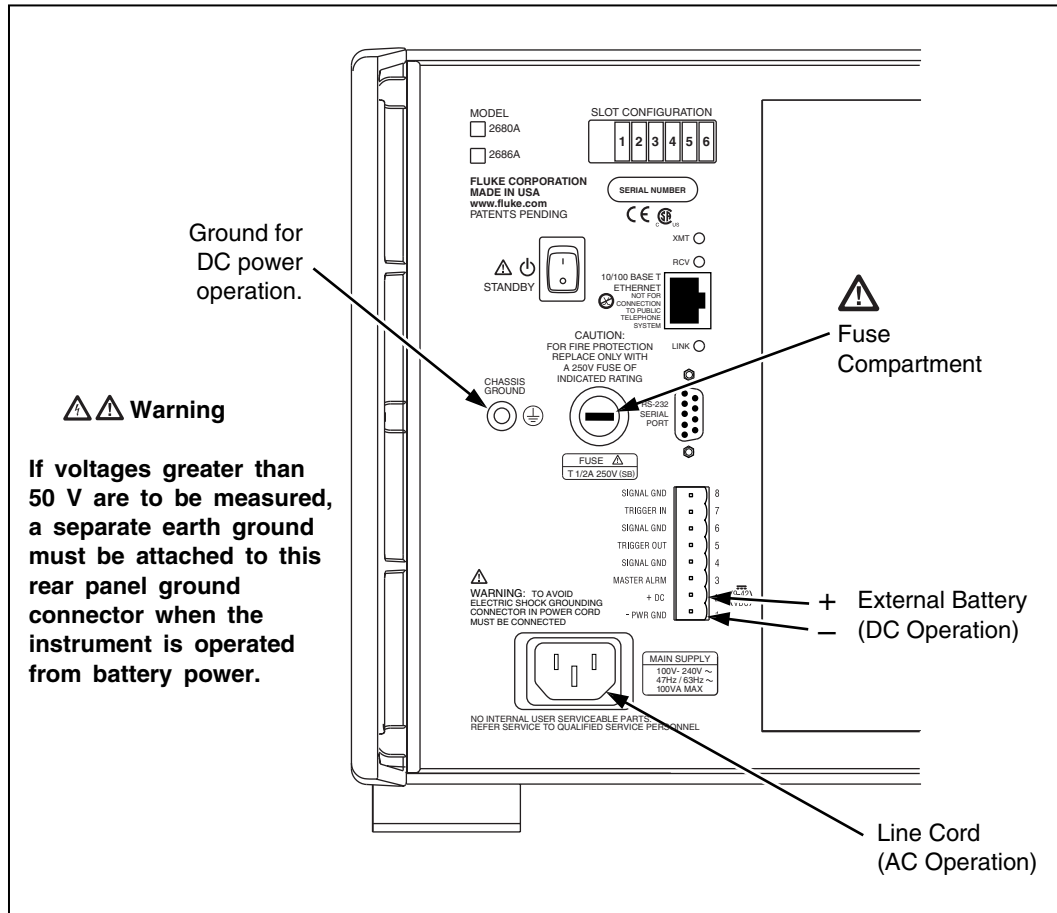

alg52f.eps

Figure 2-2. Connecting the Instrument to a Power Source

⚠️⚠️ Warning

To avoid shock hazard when powering the instrument with ac power, connect the power cord to a receptacle with an earth ground.

Operating Using AC Power

Plug the line cord into the connector on the rear of the instrument as shown in Figure 2-2. The instrument operates on any line voltage between 100 – 240 V ac without adjustment. Fluke warrants the instrument to meet specifications only at mains frequency 50 Hz and 60 Hz. Power consumption is nominally 30 watts. Be sure the line cord ground terminal connects to an earth ground.

⚠⚠ Warning

To avoid shock hazard when powering the instrument with dc power, connect the instrument ground terminal to an earth ground.

Operating Using DC Power

The instrument operates from any dc voltage between 9 and 45 V. Power consumption is a nominal 30 watts. To connect the POWER/ALARM/TRIGGER connector to the rear panel, complete the following procedure:

1. Remove the POWER/ALARM/TRIGGER connector from the packing material or instrument rear panel.
2. Loosen the wire clamp screw for the associated terminal.
3. Feed the wire into the gap between the connector body and the wire clamp.
4. Tighten the wire clamp; do not over tighten and crush the wire.
5. Repeat steps 2 through 4 for each wire.
6. Insert the connector in the rear panel.

Note

A 4 amp fuse is used to protect the dc input from over current. This fuse is located inside the 2680 Series chassis on the main controller board. The fuse should only be replaced by a Fluke qualified technician with all power disconnected from the instrument.

Grounding and Common Mode Voltage

Connect the instrument chassis to a good earth ground (Figure 2-2) to prevent a common mode voltage from raising the chassis to a high potential. For example, if you measure the voltage across a resistor in a 50 V dc circuit, the instrument reads the resistor voltage and ignores the 50 V dc common mode voltage. Since the impedance between the channel inputs and chassis ground is not infinite, a common mode voltage gradually leaks to the chassis ground. A good earth ground prevents the chassis from rising to the common-mode voltage (50 V dc in this case).

Alarm/Trigger I/O Connection

⚠⚠ Caution

To avoid damage to the instrument, do not apply any voltages greater than 30 V maximum between the ALARM/TRIGGER I/O connector terminals and signal ground.

The ALARM/TRIGGER I/O connector (Figure 2-3) on the rear panel of the instrument provides connections to Trigger In, Trigger Out, and Master Alarm I/O lines along with common ground connections. (See the Trigger Input, Trigger Output, and Master Alarm Output sections in Chapter 1 for additional information.) The dc power connection is also on this connector.

Complete the following procedure to make a connection to the ALARM/TRIGGER I/O connector:

1. Remove the ALARM/TRIGGER I/O connector from the rear panel.
2. Loosen the wire clamp screw for the associated terminal.
3. Feed the wire into the gap between the connector body and the wire clamp.
4. Tighten the wire clamp; do not over tighten and crush the wire.
5. Repeat steps 2 through 4 for each wire.
6. Insert the connector in the rear panel.

Trigger Input

Trigger Input uses terminals Trigger In and GND. A contact closure or a TTL low signal input between Trigger In and GND triggers instrument scanning when you select External Trigger as a scan parameter. A TTL signal input triggers on the falling edge of the signal. A contact closure input triggers on the "close" portion of the switch sequence. Scanning continues at the Interval 2 rate while Trigger In is held low. See Table A-3 in Appendix A for specifications.

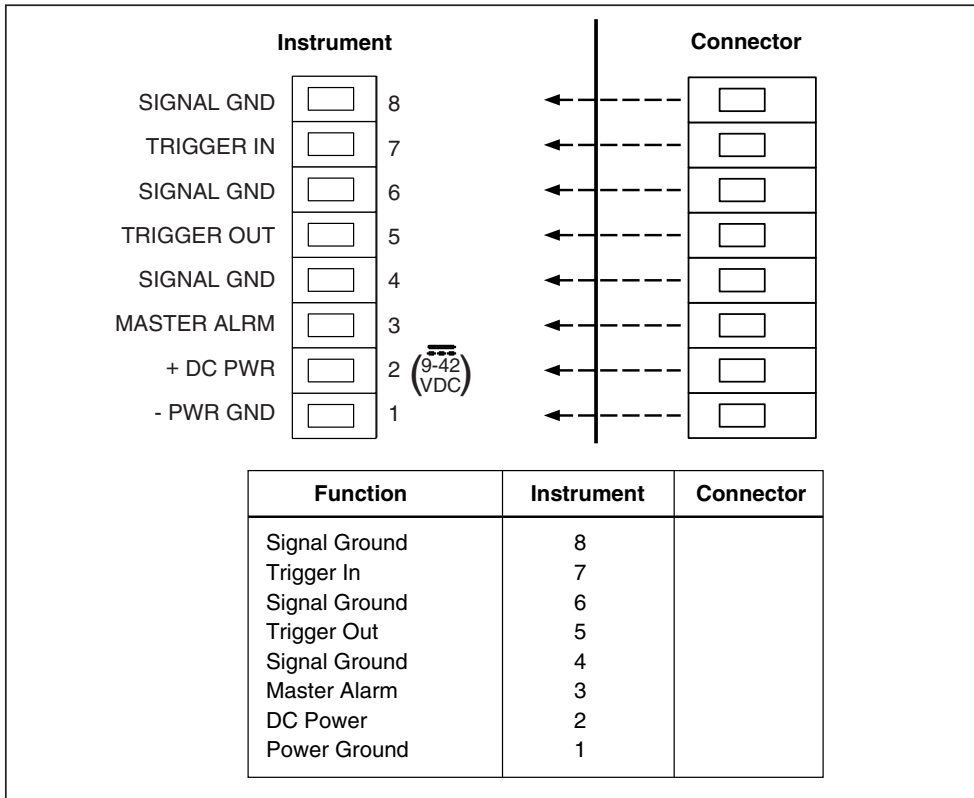

Figure 2-3. Alarm/Trigger I/O Connector

alg53f.eps

Trigger Output

Trigger Output uses terminals Trigger Out and GND, and is a TTL signal that goes to a logic low for 125 μ s every time a scan begins. Use the Trigger Output to trigger other instruments via their Trigger Input connection and to interface with external equipment. You can enable or disable the Trigger Output using Fluke DAQ software. The trigger output default is OFF. See Table A-4 in Appendix A for complete specifications.

The Trigger Out signal can be used to synchronize a number of instruments in a master/slave like setup. However, the maximum rate that a chassis can respond to a trigger signal is 300 Hz. The master module should not be set to scan more often than 300 times a second. The modules in the same chassis as the master module can be synchronized to the master if the Trigger Output signal is shorted to the Trigger Input signal line on the rear of the chassis. All slave chassis must have the Trigger Out from the master chassis connected to their Trigger In.

Master Alarm

Master Alarm uses terminals Master Alarm and GND. It is a TTL signal that goes to a logic low when any channel is in alarm while the instrument is scanning. This TTL signal output can interface with external equipment such as warning lights, alarms, paging systems, etc. See Table A-5 in Appendix A for complete specifications.

External Trigger Wiring for a Group

External Trigger Wiring for a group instrument refers to the triggering configuration in which you connect the Trigger Out line on the master instrument to the Trigger In line on each other instrument in the group and provide a common connection to the GND line for each instrument. This configuration provides improved synchronization of the group of instruments when the scanning intervals are 1 second or less.

Figure 2-4 shows a typical wiring connection for a group of instruments. Use the Fluke DAQ software to configure the group of instruments as described in Chapter 3 of this manual.

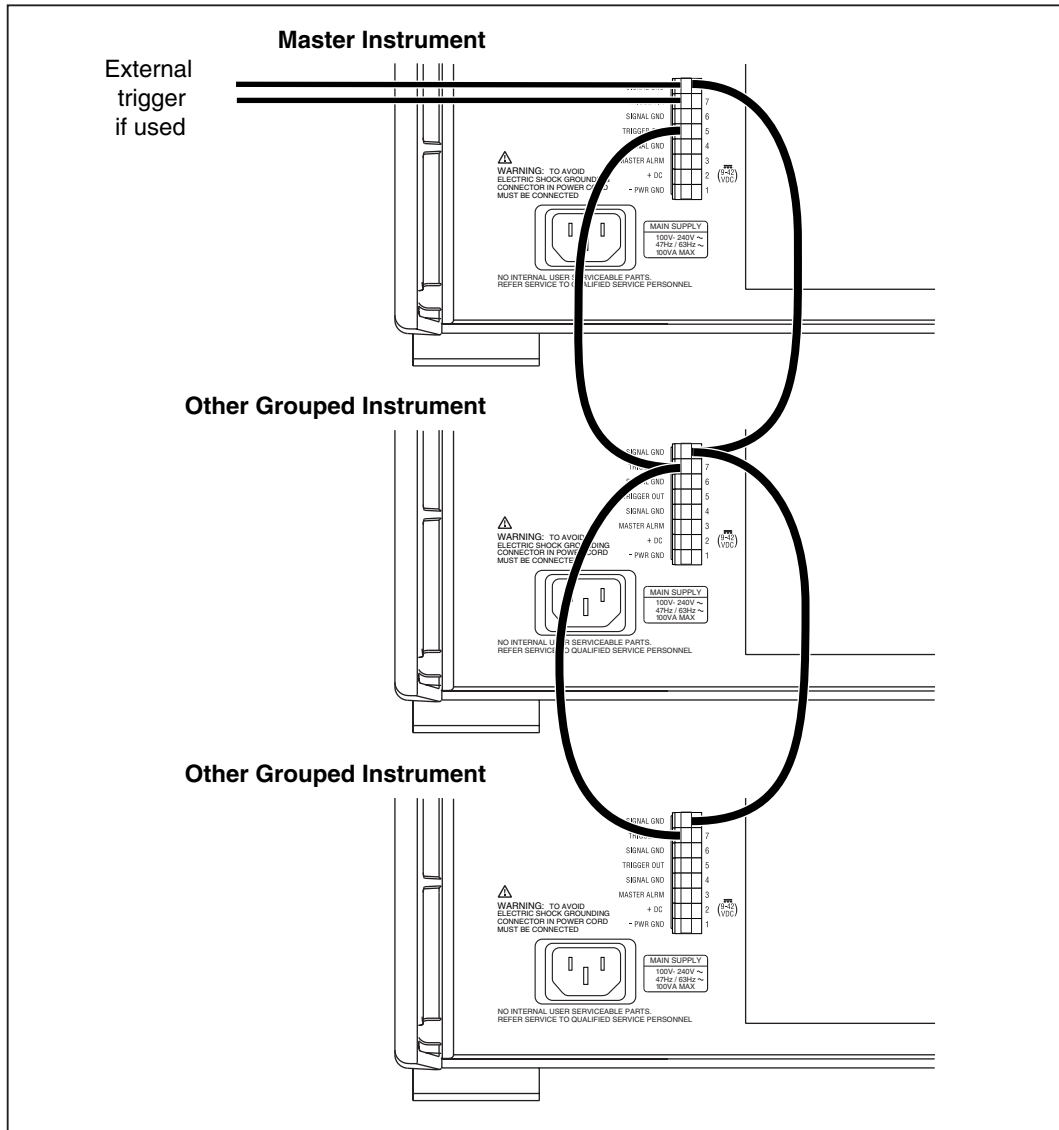

alg54f.eps

Figure 2-4. External Trigger Wiring for a Group of Instruments

Universal Input Module Analog Connections (2620A-180)

Connections to the Universal Input Module (Figure 2-5) use the H (high) and L (low) pairs of terminals for each of the 20 analog input channels. The Universal Input Module Analog Connections are used with the PAI or FAI modules.

Complete the following procedure to make connections.

⚠⚠ Warning

To avoid electric shock, remove all inputs from live voltages before opening this module. Input wiring may be connected to live voltages.

⚠⚠ Warning

To prevent fire or electric shock, the rating of the external wiring insulation must be suitable for single fault conditions.

1. Remove the module from the rear panel by pressing the release tab on the side of the module and pulling the module free of the connector.
2. Loosen the two large screws on top and open the module.
3. Connect the wires to H (high/positive) and L (low/negative) for each channel.
4. Thread these wires through the strain-relief pins and out the back of the module.
5. Close the module cover, secure the screws, and insert the module in the connector at the rear of the instrument until it latches in place.

Resistance, thermistor, and RTD measurements use two terminals (one channel) or four terminals (two channels). The 4-wire connection provides increased accuracy over the 2-wire connection. Refer to Figure 2-6 for examples of 2-wire and 4-wire connections.

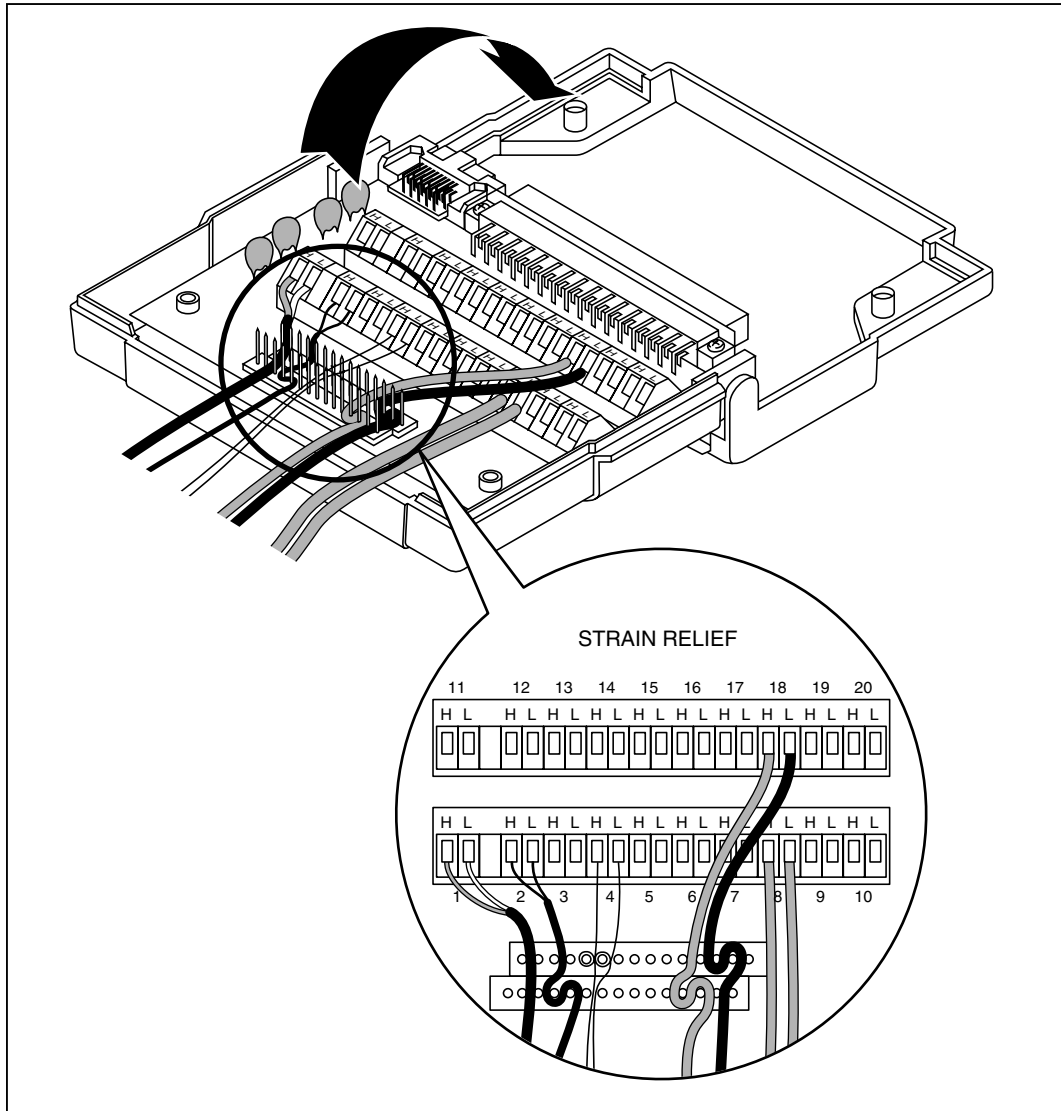
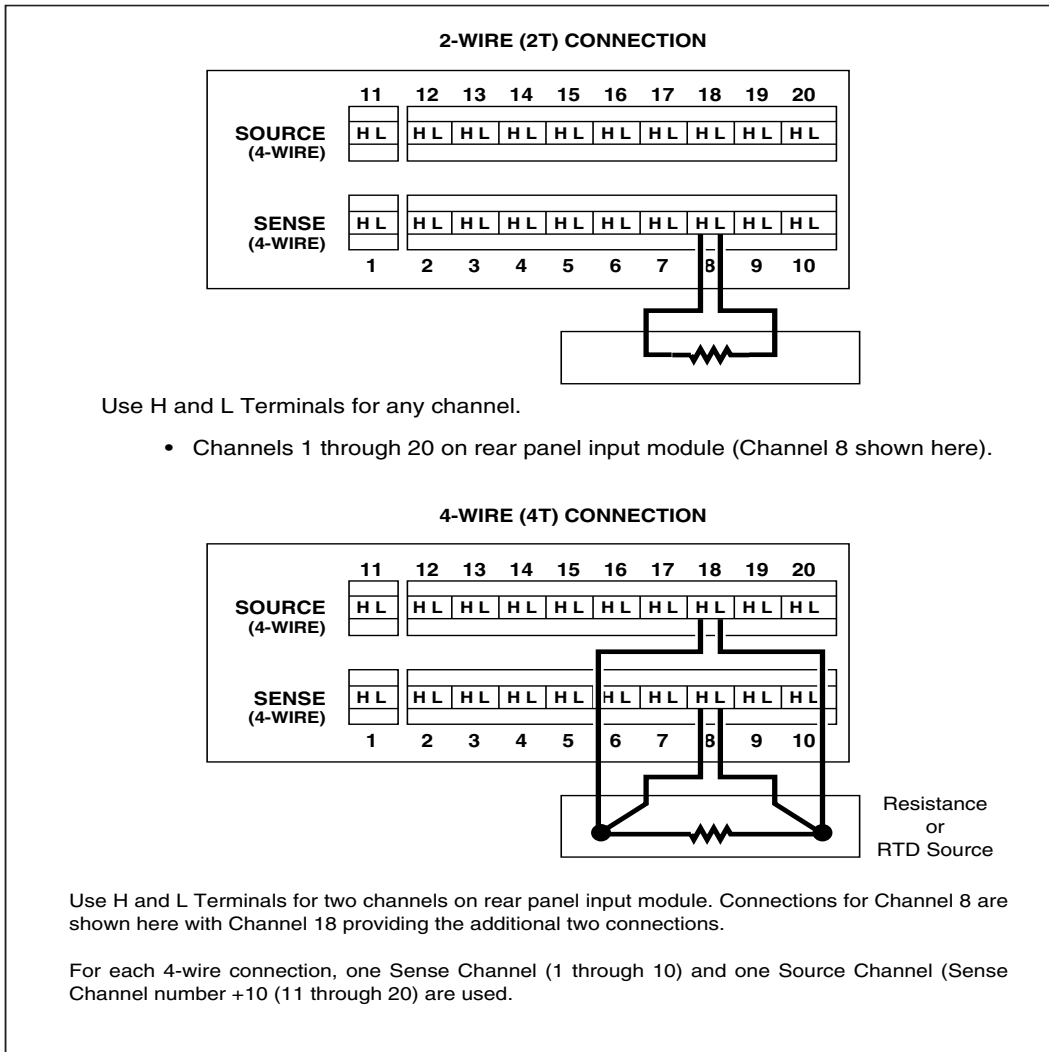

Figure 2-5. Universal Input Module Connections

alg58f.eps



alg59f.eps

Figure 2-6. 2-Wire and 4-Wire Connections

Shielded Wiring

Use shielded wires and sensors (such as thermocouples) in environments where electrical noise is present, and connect the wire shield to the chassis ground terminal. Also refer to Appendix B, Noise, Shielding and Crosstalk Considerations.

Crosstalk Considerations

Crosstalk between measurement lines causes one signal to interfere with another, introducing measurement errors. To reduce the effects of crosstalk, check the following:

- **Separate Wiring** Keep any input wiring carrying ac voltage signals physically separate from the input wiring of sensitive channels. Also keep input wiring separated from, or shielded from, ac power mains wiring.
- **Adjacent Channels** Avoid connecting input with ac voltage signals next to sensitive channel inputs. Leave unconnected channels between the inputs when possible.
- **Sensitive Channels** Avoid connecting inputs with ac voltage signals adjacent to four-terminal input channels.
- **High Impedance Inputs** Avoid high source impedances on sensitive channels, or minimize the capacitance of the sensitive channel to earth (chassis) ground for high impedance inputs.
- **Precision Resistance Measurements** Avoid connecting any ac voltage inputs when making precision high resistance measurements (resistance greater than 10 k Ω).

See Appendix B, Noise, Shielding and Crosstalk Considerations for a complete discussion of crosstalk and measurement errors.

Digital I/O Connector Module.

Caution

To avoid damage to the instrument, do not apply any voltages greater than 30 V maximum between the Digital I/O connector terminals and earth ground.

The digital I/O connector (Figure 2-7) provides connection to the digital I/O, relay, and totalizer functions.

Complete the following procedure to make a connection to these functions:

1. Remove the digital I/O connector module from the Digital I/O module (slot 6).
2. Loosen the two large screws on top and open the module.

3. Loosen the wire clamp screw for the associated terminal.
4. Feed the wire into the gap between the connector body and the wire clamp.
5. Tighten the wire clamp; do not over tighten and crush the wire.
6. Repeat steps 2 through 4 for each wire.
7. Close the module cover, tighten the screws, and insert the connector in the rear panel.

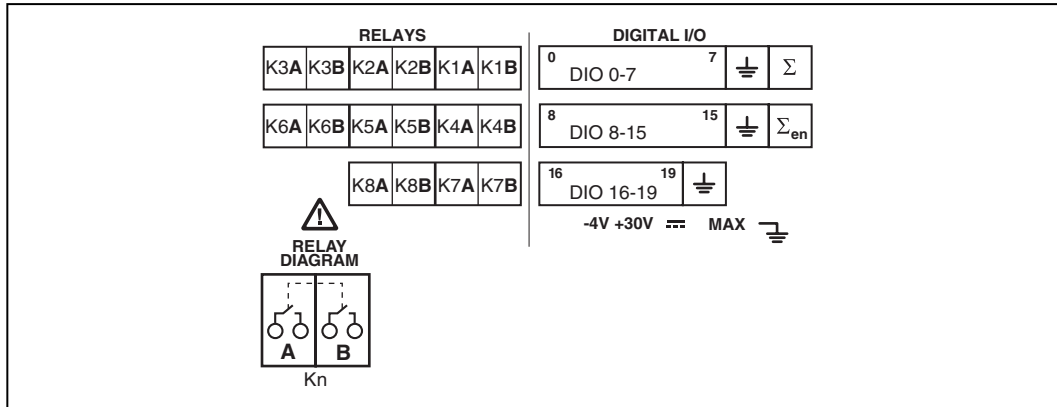

alg57f.eps

Figure 2-7. Digital I/O Connector

Digital I/O

The Digital I/O lines consist of DIO 0 to 19 and Signal GND. You can use these lines either as digital signal inputs or as digital or alarm outputs. See Table A-37 in Appendix A for complete specifications.

Totalizer

The totalizer uses terminals Σ and GND. The totalizer counts contact closures or voltage transitions with a maximum count of 4,294,967,295. See Table A-38 in Appendix A for complete specifications.

The internal numeric representation of the totalizer is a 32 bit unsigned integer for a maximum count of 4,294,967,295. However, for computed channels, this number is converted to a signed 24-bit mantissa and an 8-bit exponent following IEEE 754-1990 convention. If the totalizer value is stored in a computed channel (as an expression), the stored value will not be exact for values above 16,777,215 (2 to the 24^{th} power) because the resolution of the mantissa is exceeded. In particular, taking the difference between two timestamp values will produce reasonable results only if the totalizer is reset often enough that it never goes higher than 16,777,215.

When using the totalizer with time stamps in computed channels (e.g. rate calculations), the timestamp interval may vary depending on the number of active channels, number of active modules, and number of alarms.

Totalizer Enable

Σ en is an input that can be used to enable or disable the totalizer counting capability. In the default, unconnected state, the totalizer is enabled (high). Pulling Σ en low with a logic low input or contact closure to signal ground disables totalizer counting.

Relays

The relay contacts consist of 8 Double Pole/Single Throw (DPST) relays that can be used to provide added isolated IO connections or switch low power. See Table A-39 in Appendix A for complete specifications.

Controls and Indicators

The front panel provides a display and a set of control keys; the rear panel provides the power switch and Ethernet status indicators. See Figures 1-2 through 1-4 for an overall view of front and rear panels, and Front Panel Operating Procedures later in this chapter for procedures that use the front and rear panel controls and indicators.

Front Panel Controls

Use the front panel controls (Figure 2-8) to enter configuration parameters, and choose monitoring functions. Table 2-1 summarizes the front panel control functions.

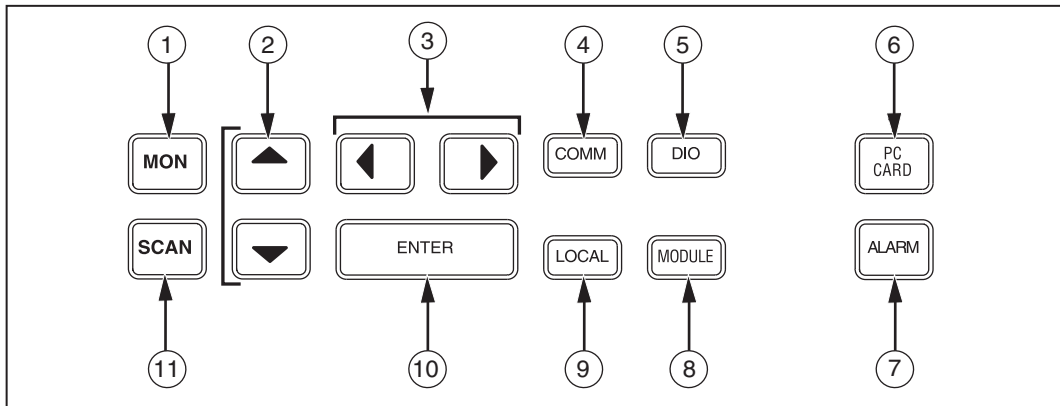

Figure 2-8. Front Panel Controls

alg01f.eps

Table 2-1. Front Panel Key Descriptions









No.	Name	Description
①	MON	Display Monitor Channel. After pressing MON, use the   keys to select the desired channel to monitor. Pressing  for down or  up will start the monitor display automatically scrolling through the channels. Press MON again to stop the monitor function.
②	 	Used to make selections in setup menus and select monitor channels. The arrow keys have an automatic repeat action.
③	 	Used to make selections in setup menus. The arrow keys have an automatic repeat action when held down for more than 1 second.
④	COMM	<p>Set up communication parameters. To review, just press COMM; to set, press and hold COMM for 3 seconds until the SET annunciator lights. If you press COMM again during configuration operations, the operation cancels. The COMM parameters are as follows:</p> <ul style="list-style-type: none"> • Base Channel Number (01 to 99) • Line Frequency (50 or 60 Hz) • Ethernet Address (Read Only) • RS-232 (Baud Rate) • Network <ul style="list-style-type: none"> Isolated Network General Network Socket Port Internet Protocol (IP) Address • Default Gateway <ul style="list-style-type: none"> Subnet Mask Default Gateway Address
⑤	DIO	<p>Display digital I/O status, relay status, and totalizer count. After pressing DIO, use the left/right arrow keys to display the DIO status and the up/down arrow keys to display the totalizer or relay status.</p> <p>This function is only available if a Digital I/O module is installed in slot 6.</p>
⑥	PC CARD	<p>Displays the PC Card menu. From the menu you can:</p> <ul style="list-style-type: none"> • Load a configuration from the card to the instrument. • Store a configuration to the card from the instrument. • Erase the card (scan and configuration data). • Initialize the card. • Get status information about the card memory usage. <p>A PC Card slot is provided on the 2686A only.</p>

Table 2-1. Front Panel Key Descriptions (cont.)

No.	Name	Description
⑦	ALARM	Used when an alarm is active on the instrument. Press the ALARM button to jump into monitor mode with the “first” (lowest)channel in alarm showing. Press ALARM again to scroll to the next channel in alarm. If you press the button when no channels are in alarm, the instrument will beep.
⑧	MODULE	Used to check which type of modules are inserted in each slot on the instrument (PAI, FAI, DIO, or none). Use the \downarrow \uparrow keys to scroll through the list.
⑨	LOCAL	When under remote control, this button returns control to the front panel. The LOCAL button can only switch the instrument out of Remote when there has been no communication from the computer for more than 30 seconds. The REM annunciator is dim when that occurs.
⑩	ENTER	Make configuration selection or terminate parameter entry.
⑪	SCAN	Displays ON/OFF menu used to enable/disable scanning.

Front Panel Indicators

The front panel indicators (Figure 2-9) consist of two five digit displays and a set of annunciators. Table 2-2 summarizes the front panel indicator functions.

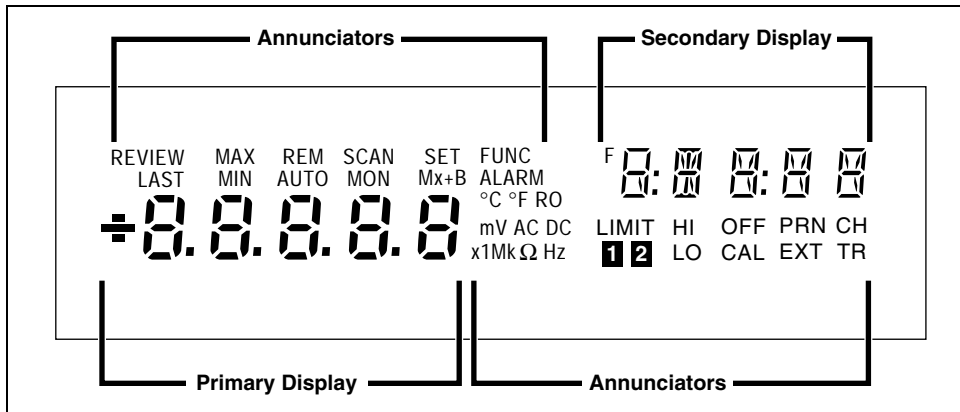

Figure 2-9. Front Panel Indicators

Table 2-2. Annunciator Display Descriptions

Annunciator	Description
REVIEW	Displays while reviewing the instrument parameters.
MAX	(Not Used.)
REM	Indicates active communications connection with the host computer (bright display) or inactive communications (dim display).
SCAN	Displays while the instrument is scanning.
SET	Displays while setting the instrument parameters.
FUNC	Displays while monitoring a computed channel.
F	(Not Used.)
LAST	(Not Used.)
MIN	(Not Used.)
AUTO	Displays while monitoring a channel with Autorange selected.
MON	Displays while monitoring a channel.
Mx+B	Displays bright while monitoring a channel scaled with an M value other than 1 and/or a B value other than 0.
ALARM	Displays bright when the Alarm Triggering interval is in use (due to a trigger alarm going off), All other alarm conditions show the annunciator dim. It is flashing if monitoring a channel that is in alarm.
°C	Displays when you monitor a channel for which the measurement function is in degrees Celsius.
°F	Displays when you monitor a channel for which the measurement function is in degrees Fahrenheit.
R0	(Not Used.)
m	Displays when you monitor a channel for which the measurement value is scaled by .001 (milli).
V	Displays when you monitor a channel for which the measurement function is volts. Operates in conjunction with the AC and DC annunciators.
AC	Displays when you monitor a channel for which the measurement function is in Alternating Current (AC).
DC	Displays when you monitor a channel for which the measurement function is in Direct Current (DC).
x1	(Not used.)
M	Displays when you monitor a channel for which the measurement value is scaled by 1,000,000 (mega).

Table 2-2. Annunciator Display Descriptions (cont)

Annunciator	Description
k	Displays when you monitor a channel for which the measurement value is scaled by 1,000 (kilo).
Ω	Displays when you monitor a channel for which the measurement function is in Ohms.
Hz	Displays when you monitor a channel for which the measurement function is in Hertz.
LIMIT	(Not used.)
HI	(Not used.)
OFF	(Not used.)
PRN	(Not Used.)
CH	Displays when the channel number is in the secondary display.
1	(Not used.)
2	(Not used.)
LO	(Not used.)
CAL	Displays when the instrument has corrupted calibration constants.
EXT	Displays when the External Trigger is enabled while scanning.
TR	Displays when Alarm Trigger or External Trigger is enabled while scanning.

Rear Panel Controls

The rear panel has a single control: the power switch (Figure 2-10). The power switch controls both ac and dc power inputs.

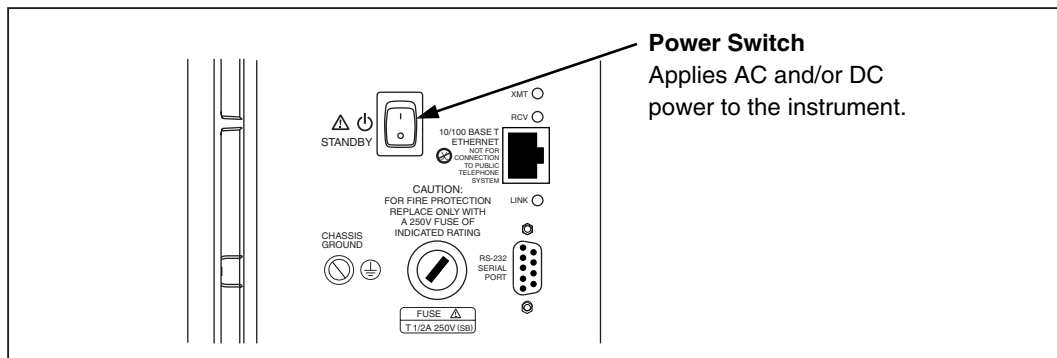

alg55f.eps

Figure 2-10. Rear Panel Controls

Rear Panel Indicators

The rear panel has three LED indicators for the Ethernet adapter (Figure 2-11).

- **Transmit (XMT)** Normal indication blinks when the instrument is transmitting data on the network.
- **Receive (RCV)** Normal indication blinks when there is any network activity. Steady off means there is no network activity.
- **Link** Remains on when the instrument connects to a hub or host computer. If off, check the hub connection. Red LED indicates a 10BaseT connection. Green LED indicates a 100BaseT connection.

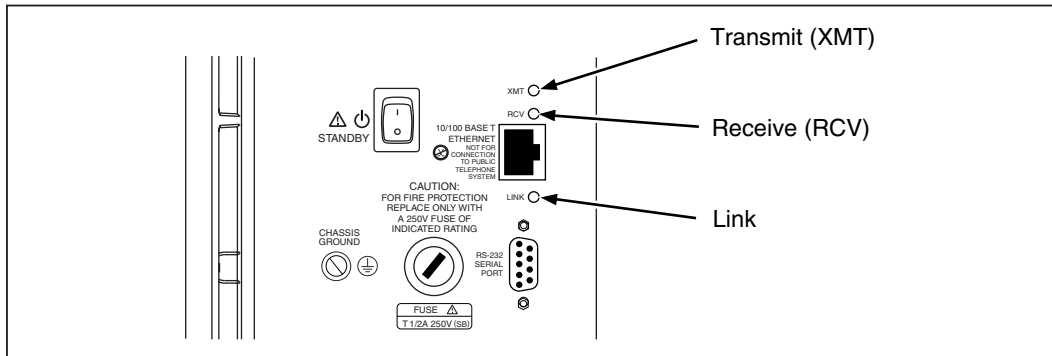

alg56f.eps

Figure 2-11. Rear Panel Indicators

Front Panel Operating Procedures

Power-On Options

There are four power-on options as listed below:

- **Normal Power-On** Turn power switch on. The instrument communication parameters are the same as when the instrument was last turned off.
- **Communication Parameter-Reset Power-On** Hold the front panel COMM key down, and then turn the power switch on. Continue holding the COMM key until the instrument beeps. The communication parameters are reset to default values (see Table 2-3).
- **Display-Hold Power-On** Hold the front panel arrow left (<) key down, and then turn the power switch on. Continue holding the < key until the instrument beeps. The instrument front panel display remains on until you press any front panel key. This allows inspection of the display segments.
- **Configuration Reset** During power up, the current module configuration is evaluated against the stored module configuration used for the last scan. If configurations are different, one or more error messages will be generated. This feature helps identify faulty modules or modules that may have been accidentally removed from the system. If the configurations do not match, the stored configuration may be reset to the current configuration from the front panel. Resetting the stored configuration will eliminate the unwanted error messages. To reset the configuration from the front panel, hold the MODULE button down, and then turn on power. Continue holding the MODULE button until the instrument beeps. You can accomplish the same thing using Fluke DAQ software to download a new configuration.

Each power-on sequence includes a four second self-test routine. If the self-test fails, the instrument displays ERROR in the primary display with a code character in the secondary display. See Chapter 4 for information on error codes.

Table 2-3. Instrument Default Parameters







Parameter	Default Setting
Base Channel Number	1
Line Frequency	60 Hz
Network Selection	Isolated Network
Socket Port	4369
Internet Protocol Address	---.---.---.--- (dashes)
Baud Rate	9600
Default Gateway	OFF

Displaying a Monitor Channel

Perform the procedure below to monitor an instrument analog channel (101 to 620) or computed channel (901 to 960). See Figure 2-12 for examples.

- **Channel Display** When you press the MON key, the first monitor channel displayed is the channel most recently monitored. After power-on, reset, configuration, or self-test commands, the channel displayed is the lowest numbered configured channel. When no channels are configured, monitoring is not available. (Under this condition, an error beep occurs when you press the Monitor key.)
- **Monitor Display** The initial monitor display is a series of dashes, which lasts for approximately one second. The measurement then appears in the primary display (the secondary display shows the Global Channel Number). The MON (monitor) annunciator is on when monitoring.
- **Monitor Reading Updates** The instrument updates monitor readings once per second.

Table 2-4. Displaying a Monitor Channel

	Press the MON (Monitor) key to monitor a channel. You can use Monitor whether the instrument is scanning or not scanning.
	Use the up/down arrow keys to select the desired channel. The instrument will not allow selection of channels that are set to OFF.
	
	Use the left/right arrow keys to enable the autoscroll feature. In Autoscroll Mode, the left arrow key autoscrolls down through configured channels and the right arrow key autoscrolls up through configured channels.
	
	Press the MON key again to exit.

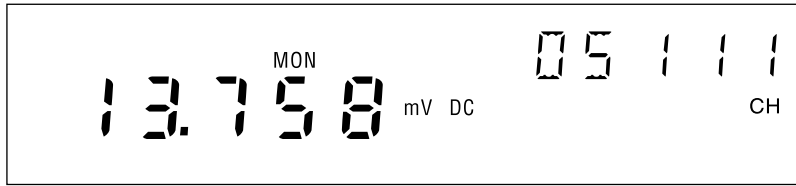

Monitor display for 13.758 mV DC, GCN (Global Channel Number) 05111

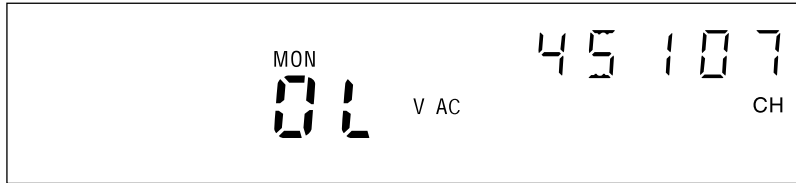

Monitor display for Scale Overload V AC (reading is greater than the selected range), GCN 45107

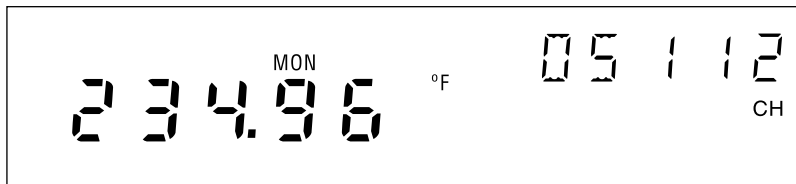

Monitor display for 234.96°F (Thermocouple), GCN 05112 (**otc** displays for open thermocouple)

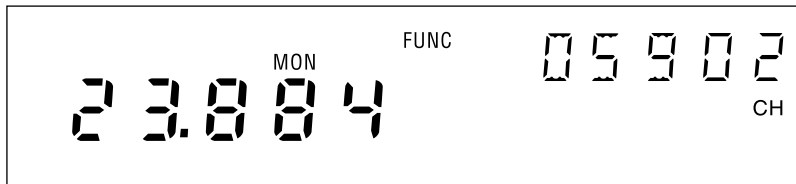

Monitor display for 23.884 FUNC (Computed Channel), GCN 05902

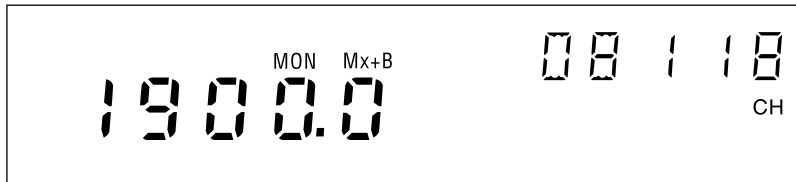

Monitor display for analog channel 18 with Mx+B scaling, GCN 08118







Figure 2-12. Examples During Monitor

Displaying the Digital I/O Status

Perform the procedure in Table 2-5 to display an instrument Digital I/O line status. The instrument updates the DIO display once per second. (See Figure 2-13 for examples.) .

- **Number Of DIO Lines** There are twenty DIO lines: DIO 0 to DIO 19. You can assign DIO lines as alarm outputs or as digital inputs or outputs. For example, a switch closure can toggle a DIO line as an input.
- **DIO Status Display** DIO status display is in the form nnnn-nnnn-nnnn-nnnn with four bits in view at a time.

Table 2-5. Displaying the Digital I/O Status

	Press the DIO (Digital I/O) key to view the Digital I/O status. You can display the Digital I/O status whether the instrument is scanning or not scanning.
	Press the up/down arrow keys to select DIO display (if necessary).
	
	Press the left/right arrow keys to display the desired DIO line, DIO19 to DIO0. Hyphens divide the display, for example, 1111-0000-0000-0000-0000.
	
	Press the DIO key again to exit. Fluke DAQ Software can also display the Digital I/O status.

Input example Toggling DIO7 between open circuit and ground results in I/O status of 1111 1111 1111 1111 1111 and 1111 1111 1111 0111 1111.







Output example Associating I/O line DIO0 with an alarm results in I/O status of 1111 1111 1111 1111 1111 when the channel is not in alarm and 1111 1111 1111 1111 1110 when the channel is in alarm. External equipment such as warning lights can be controlled by the logic low output on the Digital I/O connector.

Associating an I/O line with an alarm condition is part of the alarm's configuration procedure. See Alarms in Chapter 3 for more information.

Displaying Relay Status

Similar to DIO lines, there are 8 relay outputs: Rly 1 to Rly 8. The relay outputs can be statically set or associated with an alarm output. Display is in the form nnnn-nnnn with five characters in view at a time.

Table 2-6. Displaying Relay Status

	Press the DIO (Digital I/O) key to view the Relay status.
	Press the up/down arrow keys to select Relay.
	
	Press the left/right arrow keys to display the desired Relay line, Rly8 to Rly1.
	Hyphens divide the display, for example, 1111-0000.
	Press the DIO key again to exit.

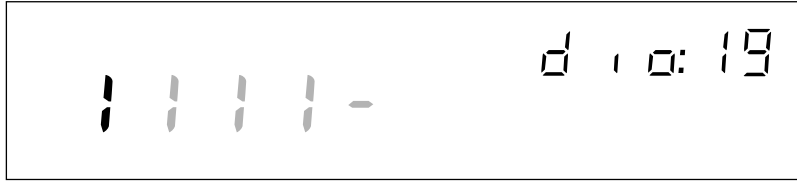

Digital I/O status display for DIO line 19 (for example 1111-0000-0000-0000-0000)

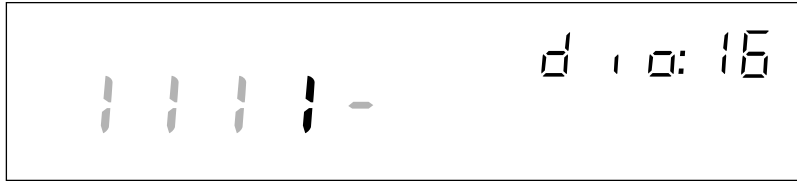

Digital I/O status display for DIO line 16 (for example 1111-0000-0000-0000-0000)



Relay status display for Relay 1 (for example 1111-0000)

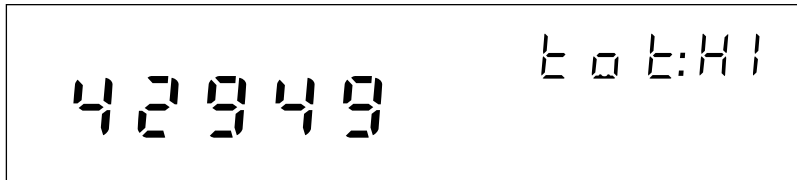

Totalizer status display for the high digits (for example 4294967295)

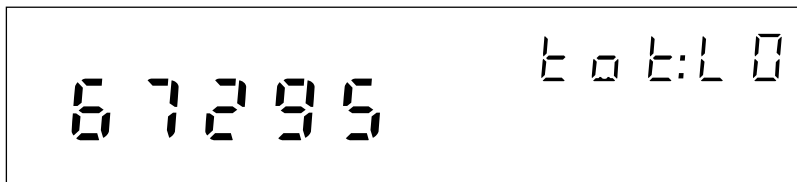

Totalizer status display for the low digits (for example 4294967295)





Figure 2-13. Examples for Digital I/O, Relay, and Totalizer Status

Displaying the Totalizer Status

Perform the procedure in Table 2-7 to display the instrument totalizer status. The instrument updates the totalizer display once per second. (See Figure 2-13 for examples.) To initialize the totalizer count, cycle the instrument power. You can also configure Fluke DAQ software to initialize the totalizer count when it starts logging.

- **Maximum Totalizer Count** The totalizer counts switch closures or voltage transitions with a maximum count of 4,294,967,295.
- **Totalizer Status Display** The instrument displays the totalizer status in two five digit segments; high (HI) and low (LO). Using the maximum count of 4,294,967,295 as an example, the HI five digit segment would display 42949 and the LO five digit segment 67295.

Table 2-7. Displaying Totalizer Status







	Press the DIO (Digital I/O) key to view the totalizer status. You can view the totalizer status whether the instrument is scanning or not scanning.
	Press an up/down arrow key to advance to the totalizer display. The 10 digits display in a five digit tot:HI count and five digit tot:LO count.
	
	Press the DIO key again to exit. Fluke DAQ software also provides a display of the totalizer status.

Reviewing and Setting the Base Channel Number

Perform the procedure in Table 2-8 to review or set the Base Channel Number (BCN). The BCN identifies the instrument. The BCN is also the first two digits of the Global Channel Number (GCN), which uniquely identifies each instrument channel. For example, a GCN of 27116 indicates instrument 27 and analog channel 116. (See Figure 2-14 for examples.)

- **BCN Range** The BCN can be any number from 01 to 99. If you plan to install Fluke DAQ software for isolated network operation, each instrument on the network must have a unique BCN.
- **BCN Review or Set identifier** The REVIEW annunciator displays when reviewing the BCN; the SET annunciator displays when setting the BCN.

Table 2-8. Reviewing and Setting the Base Channel Number

COMM	Press the COMM key to review the Base Channel Number (BCN), or press and hold the COMM key for 3 seconds to set the BCN.
 	Press the up/down arrow keys until bASE (Base Channel Number) appears in the primary display (COMM appears in the secondary display).
ENTER	Press the ENTER key. bASE appears in the secondary display and the current BCN (two digits) in the primary display.
 	For BCN set procedures, press the left/right arrow keys to select the BCN 10s or 1s digit position (highlighted).
 	Press the up/down arrow keys to select the desired number, 0 to 9, for the positioned BCN digit. In this manner, set both BCN digits.
ENTER	Press the ENTER key to exit. (Pressing any other function key will cancel set operations.)

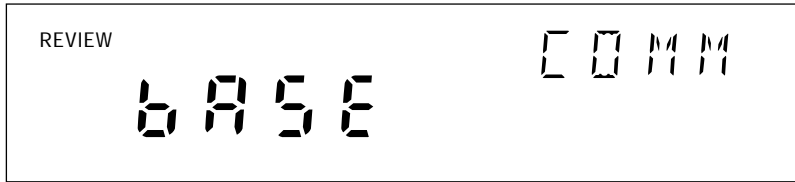

Communications display for reviewing the Base Channel Number (BCN)

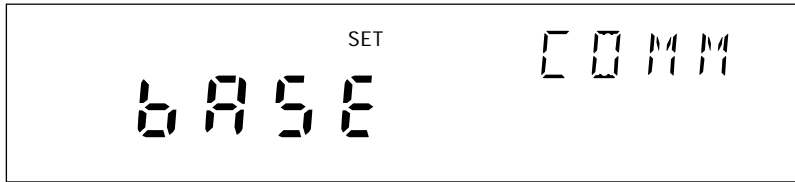

Communications display for setting the BCN



Base Channel Number display for setting the BCN 10s digits (for example, 45)

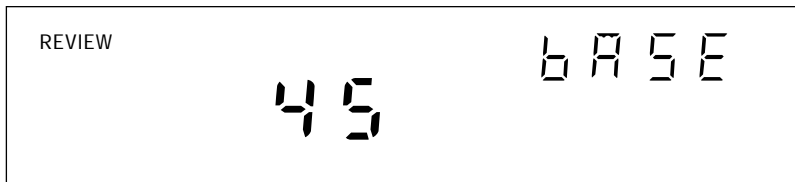

Base Channel Number display for reviewing the BCN number (for example, 45)



Front Panel display for a instrument with BCN 45





Figure 2-14. Examples for Reviewing and Setting the BCN

Reviewing and Setting the Line Frequency

Perform the procedure in Table 2-9 to review or set the line frequency. Line frequency selection allows the instrument to optimize internal circuitry for best accuracy. (See Figure 2-15 for examples.)

- **Line Frequency Choices** Select 50 Hz or 60 Hz as the frequency of the primary power when an ac source powers the instrument.

Table 2-9. Reviewing and Setting the Line Frequency

COMM	Press the COMM key to review the Line Frequency setting, or press and hold the COMM key for 3 seconds to set the Line Frequency.
 	Press the up/down arrow keys until LinE (Line Frequency) appears in the primary display (COMM appears in the secondary display).
ENTER	Press the ENTER key. LinE appears in the secondary display and the current LinE frequency setting is in the primary display.
 	For Line Frequency set procedures, press the up/down arrow keys to select 50 (Hz) or 60 (Hz) line frequency (current setting appears bright).
ENTER	Press the ENTER key to exit. (Pressing any other function key will cancel set operations.)

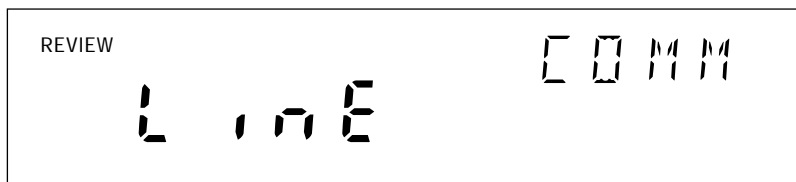

Communications display for reviewing the line frequency

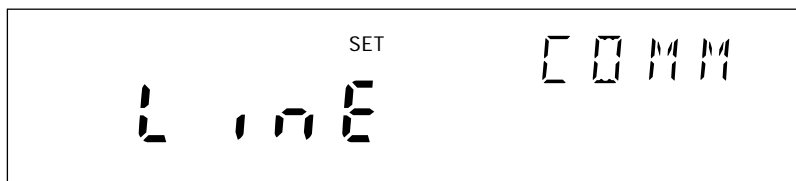

Communications display for setting the line frequency

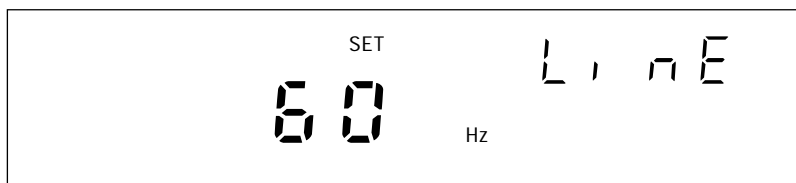

Line frequency display for setting the line frequency to 60 Hz

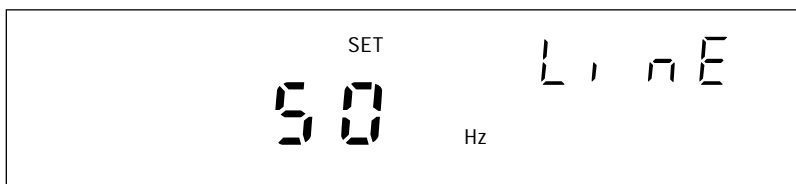

Line frequency display for setting the line frequency to 50 Hz

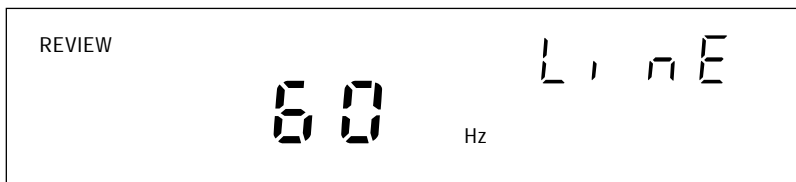

Line frequency display for reviewing the line frequency (60 Hz)





Figure 2-15. Examples for Reviewing and Setting the Line Frequency

Reviewing and Setting the Network Type

Perform the procedure below to review or set the network type to isolated. Perform the procedure in Table 2-11 to review or set the network type to general. An isolated network consists of only 2680 Series instruments and one or more host computers. A general network consists of instruments, host computers, and possibly servers, routers, gateways, or other network devices. (See Figure 2-16 for examples.)

If you use Fluke DAQ software for isolated network operation and set the instruments' network type to isolated, you do not need to know or set IP addresses for your instruments.

Table 2-10. Reviewing and Setting the Network Type

COMM	Press the COMM key to review the network type, or press and hold the COMM key for 3 seconds to set the network type.
 	Press the up/down arrow keys until nEt (Network) appears in the primary display (COMM appears in the secondary display).
ENTER	Press the ENTER key. nEt appears in the secondary display and ISo (isolated network) or gEn (general network) is in the primary display.
 	To set the network type to isolated, press the up/down arrow keys to select ISo (current setting appears bright).
ENTER	Press the ENTER key to exit. (Pressing any other function key will cancel set operations.)

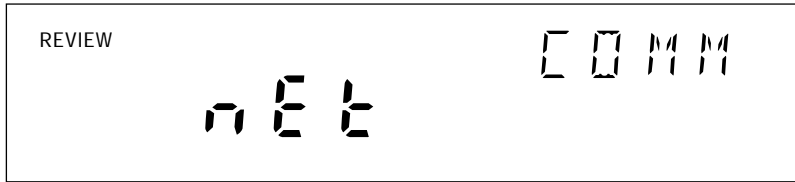

Communications display for reviewing the network type

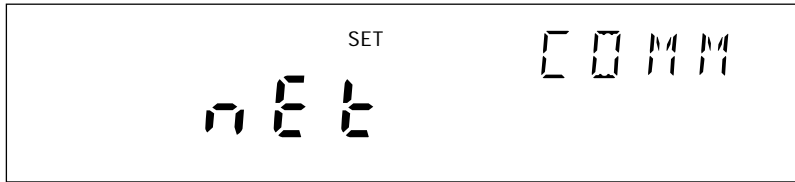

Communications display for setting the network type

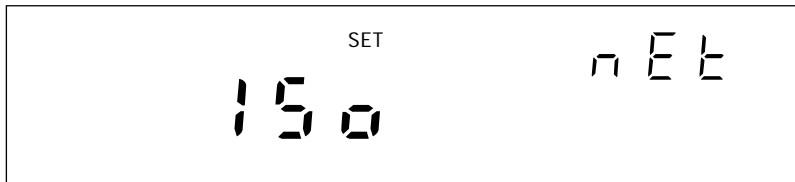

Network display for setting the network type to isolated



Network display for setting the network type to general









Network display for reviewing the network type (isolated network)

Figure 2-16. Examples for Reviewing and Setting the Network Type

If you set Fluke DAQ Software for general network operation, you must set the network type of each instrument to general. You will need to enter an IP address, and possibly a socket port, subnet mask and gateway address into each instrument. Get this information from your network administrator.

Table 2-11. Reviewing and Setting the Network Type to General

	Press the COMM key to review the network type, or press and hold the COMM key for 3 seconds to set the network type.
	Press the up/down arrow keys until nEt (Network) appears in the primary display (COMM appears in the secondary display).
	Press the ENTER key. nEt appears in the secondary display and ISo (isolated network) or gEn (general network) is in the primary display.
	To set the network type to general, press the up/down arrow keys to select gEn (current setting appears bright).
	Press the ENTER key. (Pressing any other function key will cancel set operations.) This displays the current Socket Port.
	Press the ENTER key. This displays the first digit of the Internet Protocol address (segment IP:0).
	Press the ENTER key to exit. You must set an IP address and Socket Port when using a general network.

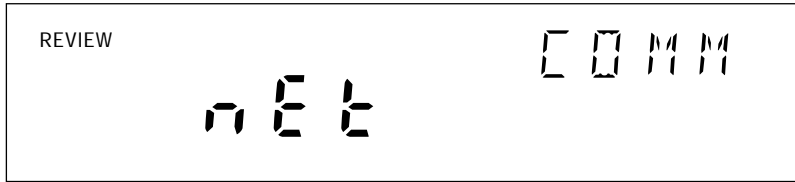

Communications display for reviewing the network type



Communications display for setting the network type



Network display for setting the network type to general



Socket Port display for setting the first digit (for the example 04369)



Socket Port display for setting the second digit (for the example 04369)

Figure 2-17. Examples for Reviewing and Setting General Network Parameters

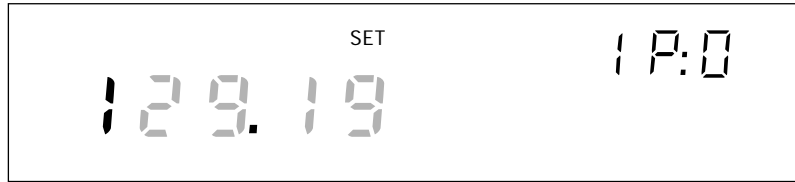

IP address display for setting an IP:0 digit (for example, 129:196:152:101)

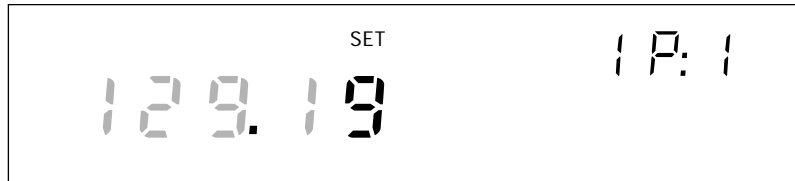

IP address display for setting an IP:1 digit (for example, 129:196:152:101)



IP address display for setting an IP:1 digit (for example, 129:196:152:101)

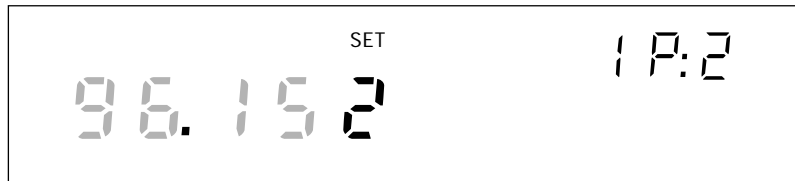

IP address display for setting an IP:2 digit (for example, 129:196:152:101)

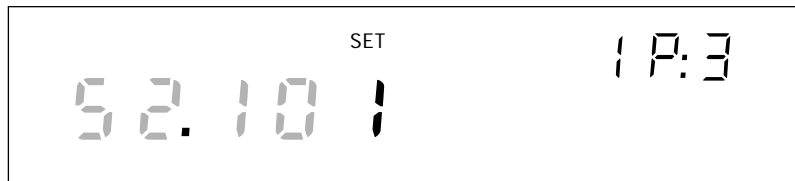

IP address display for setting an IP:3 digit (for example, 129:196:152:101)









Figure 2-17. Examples for Reviewing and Setting General Network Parameters (cont)

Reviewing and Setting the General Network Socket Port

Perform the procedure in Table 2-12 to review or set the general network Socket Port (1024 to 65535). The default port is 04369. In order to communicate with each other, a host computer and an instrument must use the same socket port number. (See Figure 2-17 for examples.) Typically, the default port does not need to be changed.

- **General Network Socket Port** Enter the Socket Port supplied by your network administrator.

Table 2-12. Reviewing and Setting the General Network Socket Port









	Press the COMM key to review the network settings, or press and hold the COMM key for 3 seconds to set the network settings.
	Press the up/down arrow keys until nEt (Network) appears in the primary display (COMM appears in the secondary display).
	Press the ENTER key. nEt appears in the secondary display and ISo (isolated network) or gEn (general network) is in the primary display.
	To set the network type, press the up/down arrow keys to select gEn.
	Press the ENTER key. (Pressing any other function key will cancel set operations.) This displays the current Socket Port.
	To set the socket port, press the left/right arrow keys to select the desired digit position (highlighted).
	Press the up/down arrow keys to select the desired number, 0 to 9, for the positioned Port digit. In this manner, select all Port digits.
	Press the ENTER key. This displays the first digit of the Internet Protocol address segment IP:0.
	Press the ENTER key to enter the settings and exit the procedure. (Pressing any other function key will cancel set operations.)

Reviewing and Setting the General Network IP Address

Perform the procedure in Table 2-13 to review or set the general network Internet Protocol (IP) address. (See Figure 2-17 for examples.)

- **General Network IP Address** Enter the IP Address supplied by your network administrator for each BCN. The format is four 3 digit segments: IP0.IP1.IP2.IP3.

Table 2-13. Reviewing and Setting the General Network IP Address

	Press the COMM key to review the network settings, or press and hold the COMM key for 3 seconds to set the network settings.
	Press the up/down arrow keys until nEt (Network) appears in the primary display (COMM appears in the secondary display).
	Press the ENTER key. nEt appears in the secondary display and ISo (isolated network) or gEn (general network) is in the primary display.
	To set the network type, press the up/down arrow keys to select gEn.
	Press the ENTER key. (Pressing any other key will cancel set operations.) This displays the current Socket Port.
	Press the ENTER key. This displays the first digit of the 12 digit Internet Protocol address (grouped into four 3 digit segments: IP0 . IP1 . IP2 . IP3).
	Press the left/right arrow keys to select the desired number in each segment. The selected digit is highlighted and the segment, for example, IP2, appears.
	Press the up/down arrow keys to select the desired number, 0 to 9, for the positioned IP digit. In this manner, select all 12 IP digits.
	Press the ENTER key to enter the settings and exit the procedure. (Pressing any other function key will cancel set operations.).

Reviewing and Setting the Subnet Mask and Default Gateway

If communication between the host computer and the 2680 Series passes through a router or gateway, you must set the subnet mask and default gateway address on both the host computer and the instrument. Get this information from your network administrator.

For more information on the purpose of the subnet mask and default gateway address, see Network Considerations in Appendix H.

Perform the procedure in Table 2-14 to review or set the instrument network gateway parameters. The network gateway parameters include turning the default gateway feature on or off, setting a subnet mask, and setting an IP address for the gateway attached to the local network.

Note

Set the IP address of the instrument before setting gateway parameters. The 2680 Series instrument checks the gateway IP address for validity by using the instrument IP address.

- **Default Gateway Parameters** If the 2680 Series instrument and host PC are on different subnets and must communicate through a gateway (router), turn the default gateway feature ON and enter the subnet mask and IP address of the gateway, as supplied by your network administrator. If you do not require a gateway, turn the default gateway feature OFF.
- **Subnet Mask** The subnet mask is a 32-bit binary number expressed as four 3 digit segments, like an IP address. The subnet mask, when masked with the instrument IP address, determines what the network number is. For example, if the IP address is 129.196.180.93 and the subnet mask is 255.255.255.0, the network number is 129.196.180.0.

The subnet mask contains a consecutive set of bits, starting at the highest order bit, forming a binary mask value. For example, 255.255.0.0 (binary value FFFF0000 hex) is a valid mask, but 255.255.10.0 (binary value FFFF0A00 hex) is not a valid mask, because the bits are not consecutive. 0.255.255.0 (binary value 00FFFF00 hex) is also not a valid mask, because the bits do not begin at the highest order bit.













The subnet mask must also contain a minimum number of bits depending on the class of the instrument IP address. The minimum number of bits for a class A address is 255.0.0.0, class B is 255.255.0.0 and class C is 255.255.255.0. For example, if the IP address is 129.196.180.93, a class B address, a subnet mask of 255.0.0.0 is not valid, because there are too few subnet mask bits set.

- **Default Gateway IP Address** The default gateway IP address is the IP address of a gateway (router) attached to the same network as the instrument. When the instrument detects that a host PC is not on the same network (using

the network number), the data is sent through the gateway to reach the host PC.

The network number of the instrument must match that of the gateway. For example, if the gateway IP address is 129.196.180.93, and the subnet mask is 255.255.255.0, the network number is 129.196.180.0, and the instrument IP address must be in the range 129.196.180.1 to 129.196.180.254.

Table 2-14. Reviewing and Setting the Subnet Mask and Default Gateway





COMM	Press the COMM key to review the parameters, or press and hold the COMM key for 3 seconds to set the parameters.
 	Press the up/down arrow keys until dgAtE (default gateway) appears in the primary display (COMM appears in the secondary display).
ENTER	Press the ENTER key. dgAtE appears in the secondary display, and ON or OFF is in the primary display.
 	Press the up/down arrow keys to select either ON or OFF when in set mode.
ENTER	Press the ENTER key to make the selection (pressing any other key will cancel set operations.). If you select ON, the subnet mask appears. The subnet mask display consists of four 3 digit segments: Sub0. Sub1. Sub2. Sub3.
 	Press the left/right arrow keys to select the desired number in each segment. The selected digit is highlighted and the segment, for example Sub:0, appears in the secondary display.
 	Press the up/down arrow keys to select the desired number 0 to 9, for the positioned subnet mask digit. In this manner, select all 12 subnet mask digits.
ENTER	Press the ENTER key to make the selection (pressing any other key will cancel set operations). If you enter an incorrect subnet mask, Error appears for 2 seconds, and the subnet mask selection stays displayed. Otherwise, the default gateway IP address appears. The default gateway display consists of four 3 digit segments: gAt0.gAt1.gAt2.gAt3.
 	Press the left/right arrow keys to select the desired number in each segment. The selected digit becomes highlighted and the segment, e.g. gAt:0, appears in the secondary display.
 	Press the up/down arrow keys to select the desired number 0 to 9, for the positioned default gateway IP digit. In this manner, select all 12 default gateway IP digits.
ENTER	Press the ENTER key to make the selection (pressing any other key will cancel set operations). If you enter an incorrect default gateway IP, Error displays for 2 seconds, and the default gateway IP selection stays displayed. Otherwise, the procedure exits.

Viewing the Instrument Ethernet Address

Perform the procedure in Table 2-15 to view the Instrument Ethernet address. (See Figure 2-18 for examples.) The network administrator must know the instrument Ethernet address when the instrument operates on a general network. You do not need this information when you operate the instrument on an isolated network.

- **Ethernet Address Format** The Ethernet address is a 12 digit hexadecimal number. For example, 00:80:40:12:34:56. The first 6 hexadecimal digits represent a manufacturer. The remaining digits are a sequential number assigned during manufacturing. Ethernet addresses are always unique; they are never altered, reused, or duplicated.
- **Ethernet Address Display** The Ethernet address display consists of six 2 digit segments: Eadr 0 to Eadr 5. In the example above, Eadr0=00, Eadr1=80, Eadr2=40, Eadr3=12, Eadr4=34, Eadr5=56.

Table 2-15. Viewing the Instrument Ethernet Address

	Press the COMM key to open the communications display because this is a review process only.
	Press the up/down arrow keys until EAdr (Ethernet Address) appears in the primary display (COMM appears in the secondary display).
	Press the ENTER key. Eadr0 appears in the secondary display, the first 5 digits of the Ethernet address appears in the primary display (always 00.80.40).
	Press the left/right arrow keys to display each byte: Eadr0 (always 00).
	Eadr1, Eadr2G, then Eadr3, Eadr4 and Eadr5. Press the COMM key again to exit.



Communications display for viewing the instrument Ethernet address

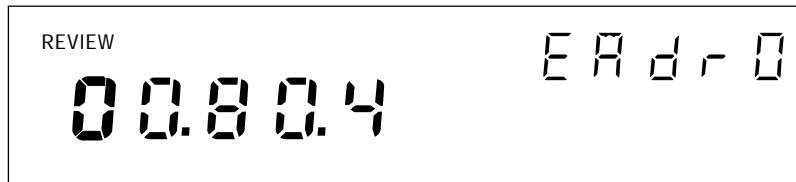

Ethernet address display for viewing byte 0 (for example 00-80-40-12-34-56)

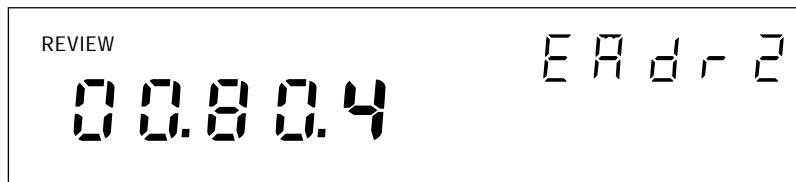

Ethernet address display for viewing byte 2 (for example 00-80-40-12-34-56)

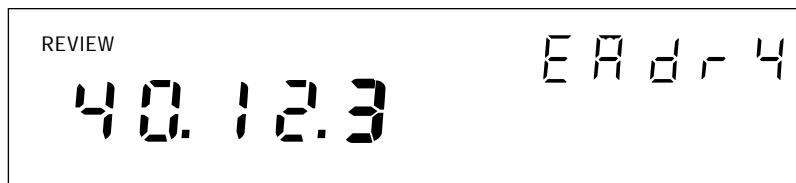

Ethernet address display for viewing byte 4 (for the example 00-80-40-12-34-56)



Ethernet address display for viewing byte 5 (for example 00-80-40-12-34-56)

Figure 2-18. Examples for Viewing the Ethernet Address

Reviewing and Setting PC Card Options

PC ATA flash memory cards provide a convenient way to store information. Only a single stored configuration and a single set of scan data can be stored on the card. The configuration file contains instrument configuration information that can be used to copy configuration information from one instrument to another. The stored data on the PC card is several files. A scans data file is created whenever scanned data is stored to the card. Scan data has its own instrument configuration that is associated with the data. To store additional data on the card, the configuration in the data file must match the configuration file in an instrument or an error will occur. The stored data also has an index file, and an ID file in addition to the file that stores the scans.

There are several PC card options you can review and set using the 2686A front panel:

- Stat
Indicates of the amount of used and unused space remaining on a card.
- Init
Reformats a PC card and deletes files.
- Erase
Deletes either the data or the separate configuration file on the PC card.
- Store
Stores the configuration (to a channel level) from the 2686A to the PC card.
- Load
Loads a previously stored configuration from the card to the 2686A.

Note

When a PC card is used for data collection you should erase stored data before using the card again.

When the card is full, the 2686A instrument will stop recording data to the PC card. The scan data is still saved to the main buffer memory. You can choose to stop recording when the buffer memory is full or overwrite old scan data.

An error will result if a card has partially been filled with data from a different configuration, that is, recorded from a system where the placement or number of modules or channel or module measurement configuration is different. This can be fixed by using the front panel keys to erase the existing data in the card.

Caution

Removing the PC card while the storage LED is on may cause a loss of data. Before removing the card, stop the instrument scanning. Loss of power while storing data may also result in loss of data.

The cards can store a considerable amount of information. The amount of time to upload a 16 MB card in a 10BaseT system with low to moderate data flow can be about 33 minutes. It can be uploaded faster by putting it into a PC's card slot and uploading the file to a directory on the PC. The card data is stored in a proprietary data format and must be converted to a text or .csv format for reading. The Fluke DAQ software can convert the data from the card in the PC or in the 2686A.

Host Computer and Network Preparation

This section contains information for preparing your host computer and setting up network communication, as summarized in Figure 2-19.

Installing Host Computer Ethernet Adapter

Skip this section if you have an Ethernet adapter installed on your computer.

Since the installation procedures for Ethernet adapters change frequently and without notice, you must follow the instructions supplied with your particular Ethernet adapter. If your host computer is already on a network, it probably has an Ethernet adapter already installed.

To install an Ethernet adapter, use the following procedure:

1. Close all applications. Exit Windows and turn the host computer off.
2. Follow the installation instructions in the manual supplied with your Ethernet adapter to install the hardware.

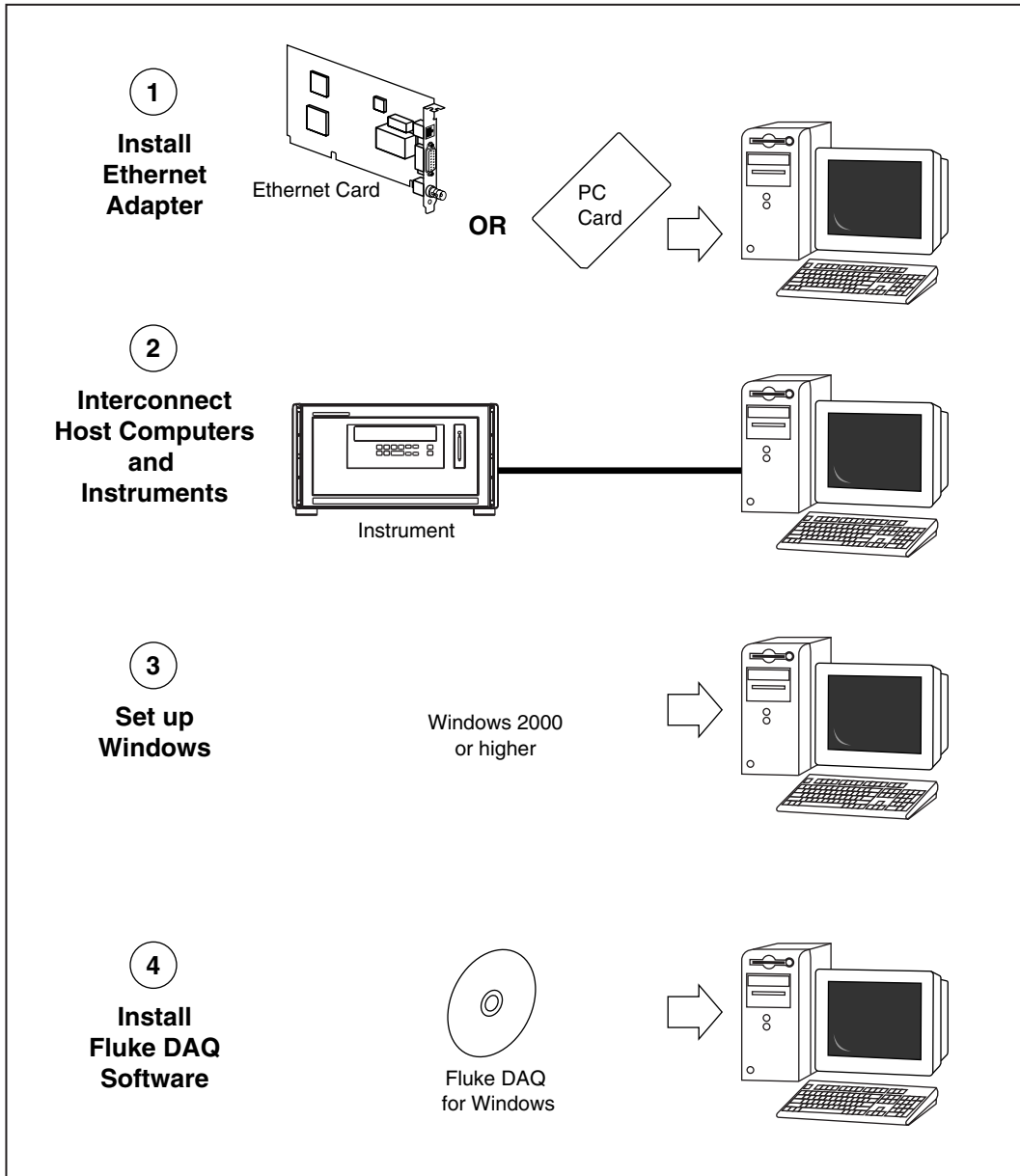

alg02f.eps

Figure 2-19. Preparing for Network Operation

Instrument and Host Computer Interconnection

You may interconnect 2680 Series instruments and host computer(s) with 10/100BaseT (twisted pair) wiring. If your site is already wired, you will probably use the wire in place. If your site is not wired, you are connecting your instrument directly to your host computer.

Host Computer/Instrument Direct Connection

You can connect a single instrument directly to a host computer using 10/100BaseT cable, but you must use a special cable that has its transmit and receive lines crossed. The crossed lines allow each end to transmit to the receive terminal at the other end. For more information, see Ethernet Cabling in Appendix G.

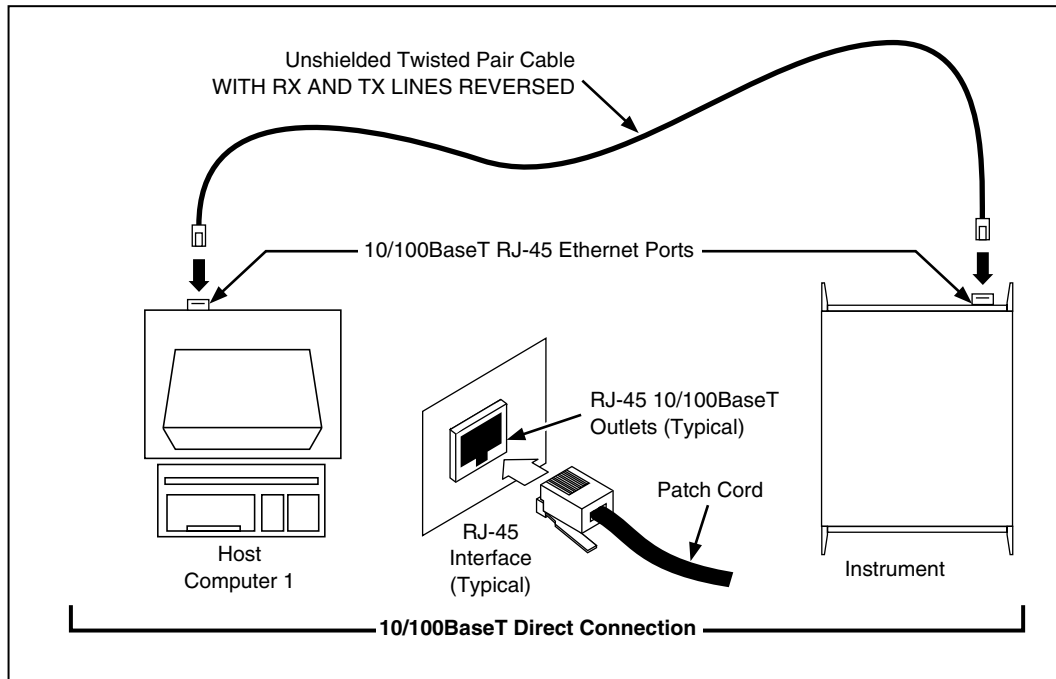

Figure 2-20. Host Computer/Instrument Direct Connection

alg04f.eps

Interconnection Using 10/100BaseT (Twisted Pair) Ethernet Wiring

The instruments support connection via twisted pair Ethernet, usually in conjunction with a "hub" for multiple instruments (See Figure 2-21). Take care that you use twisted pair wires designed for 10/100BaseT network use (phone cables will not work). Refer interconnection issues to your network administrator. For more information, see Network Considerations in Appendix H.

Direct connection between a single host computer and a single instrument with 10/100BaseT is possible, but you must use a special cable that has its transmit and receive lines crossed. (See Figure 2-20.)

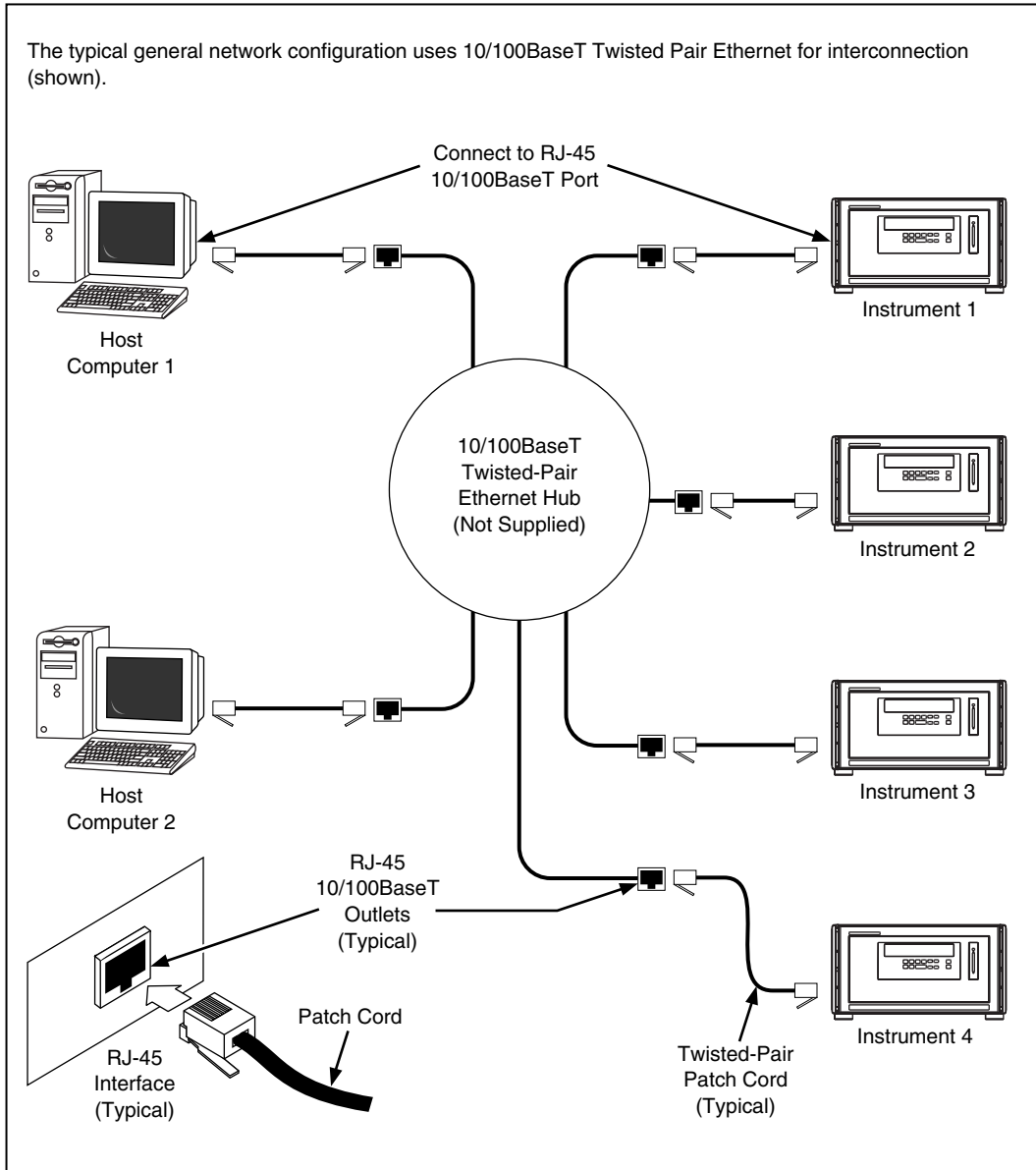

alg03f.eps

Figure 2-21. Interconnection Using 10/100BaseT (Twisted Pair) Wiring

Set Up Windows Networking

To establish Ethernet communication in your host computer, you must do the following:

- Install a driver for the adapter
- Install TCP/IP protocol stack
- Set host computer networking parameters

This section discusses installing the adapter driver and the TCP/IP protocol stack.

Windows 2000, XP, and Windows NT (Service Pack 6.0 required) provide drivers for many Ethernet adapters, in addition to the TCP/IP Internet protocol. If the driver for the network adapter is not included in Windows, or if there is an updated driver, it will be provided by the manufacturer of the adapter.

The operating system may have already detected the Ethernet adapter and added it. If not, follow the adapter manufacturer's installation instructions or use Add | Remove Hardware in the Windows 2000 or XP Control Panel. For Windows NT, follow the steps below:

1. Open the Windows NT Control Panel | Network utility via Start | Settings or My Computer.
2. Select Adapter tab, then click Add.
3. Choose the manufacturer and network adapter. Click OK. The driver for the adapter is installed.

Windows 2000 and XP should automatically install the Internet protocol (TCP/IP stack). In Windows NT, verify that TCP/IP is installed by opening Control Panel | Network (Step 1 above) and selecting the Protocol tab. If TCP/IP is not installed, click Add, select Microsoft TCP/IP and click OK to install the Internet protocol (TCP/IP) support.

Setting Host Computer Networking Parameters

This section discusses how to set your host computer networking parameters after you install your adapter and set up the network. If you plan to use Fluke DAQ software for general network operation, and you are just now enabling networking, you must set the host computer's IP address, subnet mask, and possibly its default gateway IP address. Obtain this information from your network administrator.

If you plan to use Fluke DAQ software for isolated network operation you must set the host computer's IP address to 198.178.246.1xx, and its subnet mask to 255.255.255.0. You can use any numbers for the last two digits of the host computer IP address. Each computer on the network must have a unique number (for example, 198.178.246.101 and 198.178.246.102).

If you plan to use Fluke DAQ software for general network operation and your host computer is already operating on the network, skip this section.

Complete the following procedure to set the networking parameters on Windows 2000. The procedure is similar on Windows XP and NT.

1. Open the Control Panel | Network and Dial-up Connections utility via Start | Settings or My Computer.
2. Highlight the Local Area Connection for the network adapter used for connecting to the Isolated Network and then click File | Properties.
3. On the Local Area Connection dialog, highlight Internet Protocol (TCP/IP) and click Properties.
4. Select the Use the following IP address choice and enter the IP address and subnet mask.
5. If your network administrator supplied a Default Gateway address (for General network only), select the Gateway tab. Enter the New Gateway address, click Add, and then click OK.
6. Click OK to exit Network Setup.
7. Reboot your computer (Windows NT only).

Installing Fluke DAQ Software

To install the Fluke DAQ software

- Insert the 2680A-APSW CD in the CD drive of your PC. If the program does not load automatically, find the CD-ROM drive and click on Launch.exe to launch the installation program. See Chapter 3 of this manual for information about using Fluke DAQ software.

Testing and Troubleshooting

Use the following testing procedure to check the operation of the 2680 Series instruments. Troubleshooting suggestions provide help to identify problems. See Appendix I for additional troubleshooting information.

Installing and Testing the Installation

This test procedure includes opening Fluke DAQ software, configuring and verifying communications with the instrument. Refer to Chapter 3 for detailed instructions for configuring and communicating with instruments using Fluke DAQ software.

This procedure assumes that you have performed the following relevant steps described earlier in this chapter:

- Setting line frequency and network parameters on the instrument if the defaults are not applicable
- Installing an Ethernet adapter in your host computer
- Interconnecting the host computer and the instrument
- Installing Fluke DAQ software

To install a instrument and test the installation



1. Double-click the  icon on your desktop to start Fluke DAQ.
2. Specify basic settings in the Fluke DAQ Application dialog window.

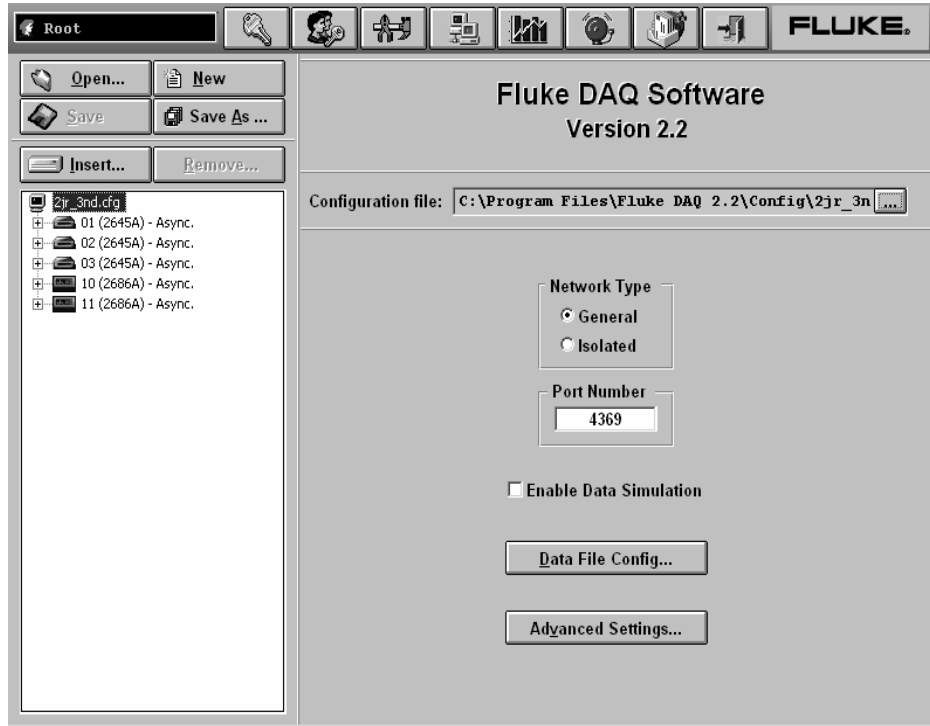

alg102s.bmp

The dialog box entries include:

Configuration file

Click the  button to load an existing configuration file.

Network Type

Isolated if the PC is connected directly to the 2680 Series instrument or General if the instrument is part of a network.

Port Number

4369 is the default port number.

Enable Data Simulation

If selected, data is simulated and the software does not actually control the instrument (for demonstration purposes).

Data File Config...

This button selects the Data File Configuration from a dialog where real-time .csv data files can be enabled and data file groups can be configured.

Advanced Settings...

This button allows you to set advanced parameters such as Autodisable Scan and Alarm Checking (Interval 3).

- To insert a instrument, select the .cfg file in the TreeView panel and click the Insert button.



alg103s.bmp

- Specify the Base Channel (1 to 99) and Instrument Type and click OK. A instrument is attached to the new configuration. As part of the insertion process, you can specify a base channel number. This number is used to identify the instrument and differentiate channels in different instruments. The Base Channel number auto-increments when you add instruments.

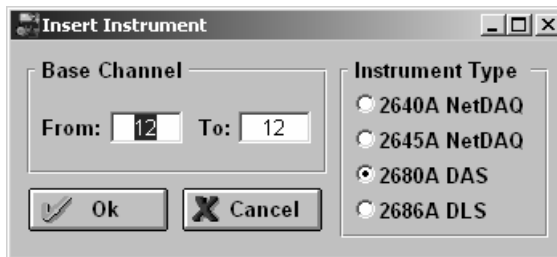

alg104s.bmp

Note

Fluke DAQ also supports 2640A and 2645A NetDAQ instruments but some of the Fluke DAQ configuration dialogs may differ from those for the 2680 Series.

- In the TreeView panel, select the instrument you just added.



alg105s.bmp

- Set the IP Address on the Instrument Settings dialog if using General Network Type (IP Address is disabled if Isolated network is used). Other fields are optional. You may need to contact your Internet support staff to determine the IP Address.

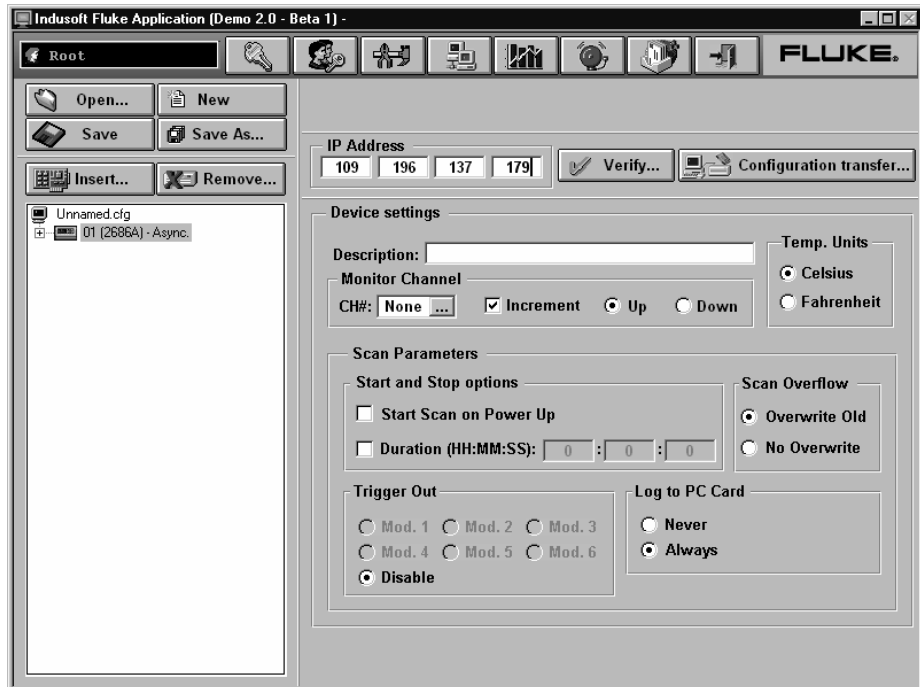

alg106s.bmp

The dialog box entries include:

IP Address

Enter the IP Address of the instrument you are adding (General network only).

Verify Button

Click the Verify button to ping the instrument and verify that the IP Address is correct. The instrument and your PC must both be connected to the network for this to work.

Troubleshooting Network Problems

Review the troubleshooting information below to help locate any network problems. Table 2-16 summarizes network messages reported by Fluke DAQ software for Windows. Table 2-17 is a summary of how to use the Ethernet LED indicators on the instrument to identify network problems.

To troubleshoot a 2680 Series network problem

1. Determine if you are using an Isolated or General network installation, and what version of Windows you are using.
2. Check that Ethernet adapter drivers are installed correctly.
3. Verify that the TCP/IP stack is installed correctly.
4. Verify that the IP address and subnet mask are correct in the Windows network settings.
5. Verify that there is only one copy of Winsock.dll on the PC.

Table 2-16. Identifying Network Problems

Symptom/Error	Reason/Possible Cause
Unable to initialize Winsock	Drivers not loaded <ul style="list-style-type: none"> • Ethernet adapter bad • Drivers missing • Wrong drivers • Wrong driver set up or command line switches • Multiple copies of drivers loaded Wrong Winsock.dll <ul style="list-style-type: none"> • Not third-party network software but its Winsock is being used by Windows (multiple Winsock libraries) • Wrong Winsock in path
Winsock.dll not found	Winsock missing <ul style="list-style-type: none"> • Winsock.dll not in path or Windows directory

Table 2-16. Identifying Network Problems (cont)

Symptom/Error	Reason/Possible Cause
Call to undefined Dynalink	<p>Wrong Winsock.dll</p> <ul style="list-style-type: none"> • Not third-party network software but its Winsock is being used by Windows (multiple Winsock libraries) • Wrong Winsock in path
Unable to open communication socket with instrument	<p>TCP/IP not loaded</p> <ul style="list-style-type: none"> • Stack not installed
Either someone else is using the instrument or the wrong TCP port number is being used in General Network mode.	<p>User error or software set up</p> <ul style="list-style-type: none"> • 2680 Series is being used by another computer on network • Socket port wrong in Fluke DAQ (General) • IP address in Fluke DAQ in use by another instrument • PC network adapter set to same IP address as the instrument <p>2680 Series hardware set up</p> <ul style="list-style-type: none"> • Socket port set wrong on instrument (if NET set to GEN) • Instrument network interface needs COMM RESET
Connection is down	<p>IP address wrong</p> <ul style="list-style-type: none"> • Computer IP address wrong or not set • Computer subnet mask wrong • Computer gateway (router) address wrong or not set • IP address set on wrong (other) network adapter <p>Drivers not loaded</p> <ul style="list-style-type: none"> • Ethernet adapter bad • Drivers missing • Wrong drivers • Wrong driver set up • Multiple copies of drivers loaded

Table 2-16. Identifying Network Problems (cont)

Symptom/Error	Reason/Possible Cause
Timeout happened during network operation	<p>Cabling problem</p> <ul style="list-style-type: none"> • Not connected • Wrong cable (10/100BaseT direct connection) • Adapter auto-sensing wrong network speed • Adapter or driver set up to wrong network speed • Bad cable <p>Instrument address wrong</p> <ul style="list-style-type: none"> • Wrong BCN (Isolated network) • Wrong IP address (General network) • Wrong subnet mask (General network) <p>Networking problem (General network)</p> <ul style="list-style-type: none"> • No default gateway or dgate set wrong on the instrument • Network fault (duplicate IP address, bad ARP, etc.) <p>Miscellaneous</p> <ul style="list-style-type: none"> • Software set to wrong network type (Isolated vs General) • Instrument set to wrong network type (Isolated vs General) • Another network adapter has IP address in same subnet <p>Interrupt problem</p> <ul style="list-style-type: none"> • Adapter IRQ set wrong or IRQ conflict • Software interrupt conflict
Loss of scan data when using multiple FAI modules	<p>It is possible that if you operate 6 FAI modules at maximum speed, data will be lost. The loss results from collecting scan data faster than can be sent through the network. To reduce the loss, either slow the scan rate or reduce the number of FAI modules running at full speed.</p>

Table 2-17. Ethernet Indicators

Indicator	Description
Instrument (10/100BaseT)	
XMT (red)	Transmit Normal indication blinks when the instrument is transmitting data on the network.
RCV (red)	Receive Normal indication blinks when there is any network activity. Steady off means there is no network activity.
LINK (red/green)	Link Remains on when the instrument connects to a hub or host computer. If off, check the hub connection. Red for 10BaseT, Green for 100BaseT.

Chapter 3

Using Fluke DAQ Software

Contents	Page
Introduction	3-3
Installing Fluke DAQ Software	3-4
Understanding the User Interface	3-5
Fluke DAQ Main Window	3-5
Using the Toolbar	3-6
Understanding the Workspace Area	3-8
Configuration Dialogs	3-9
Main Configuration Dialog	3-9
Instrument Configuration Dialog	3-9
Module Configuration Dialog	3-10
Analog Channel Configuration Dialog	3-10
DIO Configuration Dialog	3-10
Computed Channel Configuration Dialog	3-10
Communication Dialogs	3-11
Main Communication Dialog	3-11
Instrument Communication and Status Dialog	3-11
Module Communication Dialog	3-11
Digital I/O Points Dialog	3-11
Computed Channels Dialog	3-11
Communications Icons	3-12
Security Dialogs	3-12
Trend Dialog	3-13
Alarm Dialog	3-13
Mail and Web Settings Dialogs	3-13
Managing Your Network Using Fluke DAQ	3-14
Inserting and Configuring an Instrument	3-14
Inserting and Configuring a Module	3-19
Inserting and Configuring a Channel	3-23
Configuring a Computed Channel	3-26
Configuring Multiple Channels	3-29
Using Equations with Computed Channels	3-30
Starting a Scan	3-32

Starting a Configuration Scan	3-32
Starting an Instrument Scan.....	3-33
Getting Scan Data.....	3-33
Viewing and Resetting the Totalizer	3-34
PC Card Functions.....	3-34
Getting PC Card Information	3-34
Formatting the PC Card.....	3-34
Getting PC Card Scan Data	3-35
Starting Spy	3-36
Viewing Module Measurement Data.....	3-38
Using the Digital I/O Points Communication Dialog.....	3-39
Using Trend to View Collected Data.....	3-40
Changing the Trend Chart Display.....	3-43
Viewing Alarms.....	3-44
Configuring Data Files.....	3-46
Selecting a Master for a Data Group.....	3-47
Advanced Data File Configuration	3-47
Real-time Data File Creation	3-53
Main Window Advanced Settings.....	3-55
Using Fluke DAQ System Security Features.....	3-56
Configuring Web and Alarm Mail Settings	3-58

Introduction

Fluke DAQ software provides a graphical user interface (GUI) to the 2680 Series and NetDAQ data acquisition products. You can use Fluke DAQ software to easily perform the following:

Note

Fluke DAQ supports the NetDAQ models 2640A and 2645A as well as the 2680A and 2686A.

- Configure your 2680 Series network and instrument settings.
- Download/upload configuration to the instruments.
- Send commands to and take readings from analog modules and the optional DIO module.
- Monitor the instruments' on-line values and alarms.
- Plot trend charts, and a complete historical capability to retrieve historical trends, alarms and export data files in .csv format.
- Record and store scanned data on a PC Card (PCMCIA ATA format in the 2686A).

⚠⚠ Caution

Removing a PC card while the LED is on may cause a loss of data. Before removing the card, stop the instrument scanning.

Note

The material in this section describes the operation of FlukeDAQ version 2.2.

Installing Fluke DAQ Software

To install Fluke DAQ software on your computer

1. Run the Launch.exe command from your distribution CD. The installation program will prompt you for an installation location for the program and will check if there is enough free space on your hard drive for the installation.
2. Click the **Next** button and wait for the installation to finish. The install time will vary depending on the computer you are using.
3. The installation program creates a shortcut on the your desktop when the installation is complete. Double-click the shortcut to start Fluke DAQ.



Note

You may need to reboot your computer after you install the Fluke DAQ software.

The following directories and files are installed on your PC.

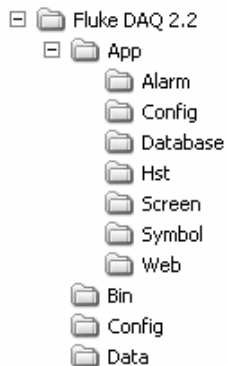

alg100s.bmp

The Fluke DAQ subdirectories contain the following information:

Alarm Collected alarm data and format information.

Config Miscellaneous files used in a system configuration.

Database Miscellaneous files related to the database collection.

Hst Data collected during scanning, one file per module.

Screen Miscellaneous files affecting the screen layout.

Symbol Bit maps used on Fluke DAQ screens.

Web Miscellaneous files associated with network communication.

Bin Binary and executable files for the Fluke DAQ application.

Config Saved configuration files.

Data Scan data files.

Understanding the User Interface

Fluke DAQ software has a standardized and easy to use interface. This section explains the components of the interface.

Fluke DAQ Main Window

The Fluke DAQ main window contains a workspace area, toolbar, and other controls to add instruments and configure your network.

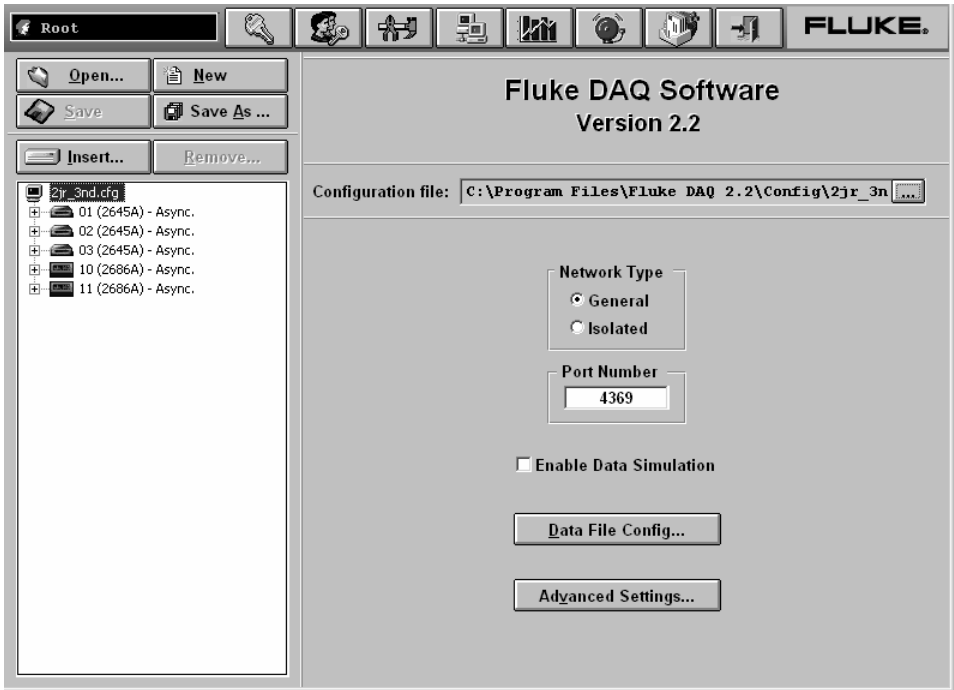

alg102s.bmp

Using the Toolbar

A toolbar appears on all of the Fluke DAQ dialogs. Use the toolbar buttons to add and configure 2680 Series instruments and to navigate through the Fluke DAQ application. Each button on the toolbar has a tool tip that identifies the button function. Using the mouse, point to a button to view the tool tip.



alg101s.bmp

Table 3-1. Fluke DAQ Toolbar Buttons









Button	Function
	<p>Logon button.</p> <p>Used to log on to the Fluke DAQ application. The Fluke DAQ administrator (Root user) is able to create user accounts and set up rights to configure instruments. Guest users do not have rights to perform configuration tasks.</p>
	<p>Security System Configuration button.</p> <p>The system security configuration feature allows the administrator to add and remove Fluke DAQ users, allow users to configure instruments, and to change user passwords. Only the administrator (Root user) can use the security system configuration function.</p>
	<p>Configuration button.</p> <p>Used to configure networks, instruments, modules, and channels.</p>
	<p>Communication button.</p> <p>Used to access the Communication dialogs, display the communication status of connected network components, and allow you to interact with those components.</p> <p>The communication icon can also assume three states in the TreeView panel.</p> <ul style="list-style-type: none"> • Dark computer screens on the icon indicates that communication is disabled. • Color on the computer screens on the icon indicates that communication is enabled. • A blinking red X through a computer screen indicates a communication failure.

Table 3-1. Fluke DAQ Toolbar Buttons (cont)

Button	Function
	<p>Trend button.</p> <p>Used to access the Trend dialog to view the scanned data collected from 2680 Series instruments and also to access the Export data feature.</p>
	<p>Alarm button.</p> <p>You can use the Alarm View dialog to view On Line and History alarms.</p> <p>The Alarm status icon can also assume two states in the TreeView panel. When an alarm is activated the Alarm icon flashes. The icon stops flashing after you give an Ack command (Last Alarm or All Alarms) in the Alarms dialog.</p>
	<p>Web and Alarm Mail Settings button.</p> <p>Used to enter Fluke DAQ web configuration information and to configure Fluke DAQ to send e-mail messages reporting alarm condition.</p>
	<p>Exit button.</p> <p>Exit the Fluke DAQ application.</p>

Understanding the Workspace Area

The Workspace Area consists of a network TreeView and a set of buttons. Use the Workspace Area to:

- Open, Save, and Create configuration files. You can also use the Save As button to rename an existing configuration file.
- Insert and Remove instruments, modules and channels
- Navigate through the configuration setup dialogs

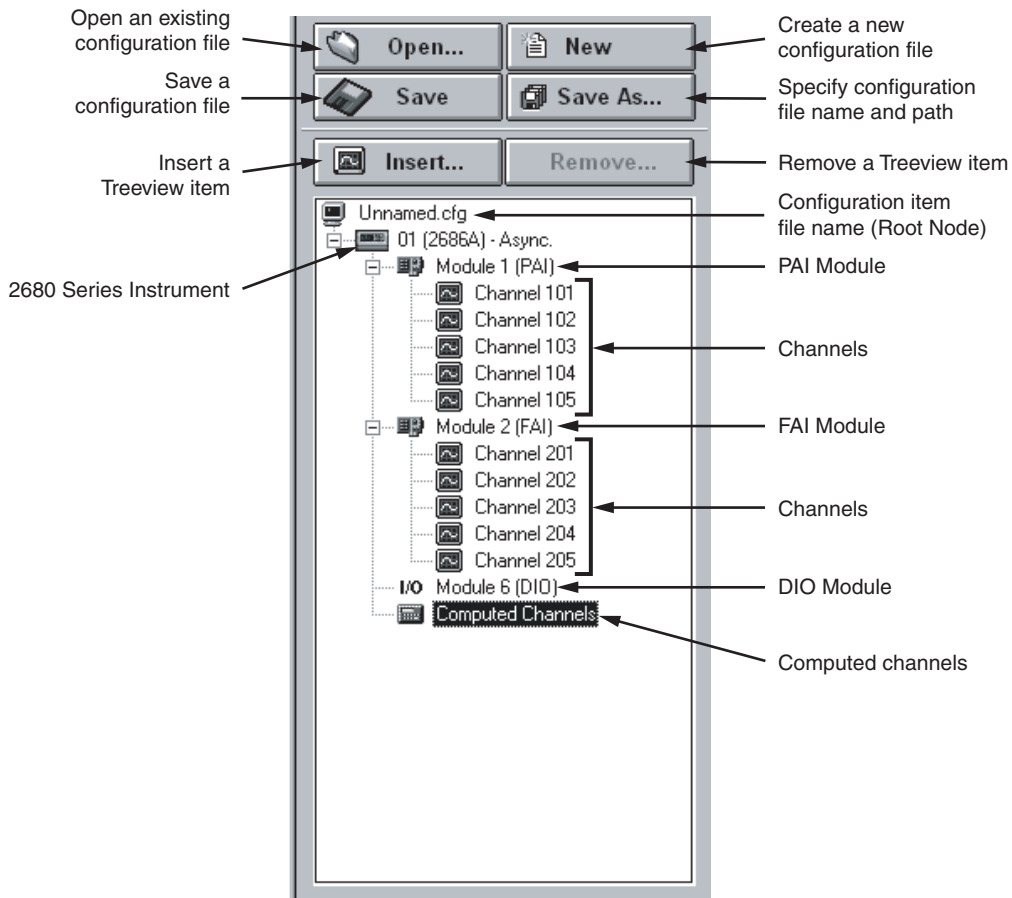

alg671.eps

Configuration Dialogs

The Configuration dialog that appears depends on the node (instrument, module, or channel) you select in the TreeView panel.

You can also use copy and paste functionality to save configuration time. Channel settings can be copied from one channel to another in the same instrument, or you can copy a whole module or a group of channel settings from one instrument to another. To copy a channel, highlight the channel you want to copy, then click the right mouse button and select Copy. Next, highlight the module where you want to add the channel, then click the right mouse button and select Paste. A new channel with the same configuration will be added to the module.

You can also use the same method to change channel settings. Highlight a channel, then click the right mouse button and select Copy. Next, highlight the channel you want to change, click the right mouse button and select Paste to paste the configuration information.

Note

As you move from a Configuration dialog to a Communication dialog, the instrument that was previously selected in the dialog is still selected. For example, if instrument 01 is selected in the Configuration dialog and you move to a Communication dialog, the instrument will only be highlighted if it was selected the last time you were in the Communication dialog. Dialog selections are remembered and are independent.

Fluke DAQ uses the following Configuration dialogs:

Main Configuration Dialog

You can use the Main Configuration dialog to select the network type (General or Isolated), Port Number, Data Simulation, and access Data File Configuration and Advanced Settings. The Main Configuration dialog appears when you click on the root node in the TreeView.

Instrument Configuration Dialog

You can configure your 2680 Series or NetDAQ instruments using the Fluke DAQ Instrument Configuration dialog. This dialog appears when you select an instrument in the TreeView. You can use the Configuration dialogs to:

- Set up the instrument network settings (IP address and Port number)
- Verify the IP Address and the connection
- Upload and download the configuration from/to the instrument
- Save and load the configuration to and from the PC card (2686A only)

Note

The Save command saves the actual 2686A configuration to the PC Card. The Load command loads the configuration from the PC Card to the 2686A.

- Set up the instrument general settings
- Specify which module will control the trigger out signal for master/slave operation
- For NetDAQ 2640A and 2645A instruments, this dialog also includes many of the settings from the 2680A/2686A Module Configuration Dialog.

Module Configuration Dialog

A 2680 Series instrument can have up to 6 modules with specific configuration settings. The Module Configuration dialog appears when you select a module in the TreeView. For NetDAQ 2640A and 2645A instruments these settings are on the Instrument Configuration instead.

Analog Channel Configuration Dialog

Use the Analog Channel Configuration dialog to set function, range, and alarm information for individual channels. You can also select multiple channels on a module and set them all at once.

DIO Configuration Dialog

Use the DIO Configuration dialog to enter totalizer configuration information. To set relays and I/O pins, see the DIO Communication dialog described later in this Chapter.

Computed Channel Configuration Dialog

2680 Series instruments can have up to 60 computed channels, with all computed channels available for configuration in one view. NetDAQ instruments have 10 computed channels.

Computed channels provide a way to directly use measurement results in a calculation. The calculation results can be used to set alarms or as part of other calculations. A computed channel is inserted in a similar manner as a channel for a module. Highlight the Computed Channel icon and click on the Insert button.

Detailed instructions for using the Configuration dialogs is provided later in this Chapter.

Note

Computed channel values are only updated on the 2680A and 2686A instruments when scanning is active.

Communication Dialogs

The Communication dialogs display the communication status of connected network components and allow you to interact with those components. Fluke DAQ uses the following Communication dialogs.

Main Communication Dialog

You can use the Main Communication dialog to start and stop scanning on all instruments at the same time.

Instrument Communication and Status Dialog

You can use the Instrument Communication and Status dialog to perform the following tasks:

- View instrument status and reset instrument errors
- Start/Stop scan on the instrument and all the modules
- Get scan data from the scan queue memory.
- View and reset the totalizer
- Upload scan data from the PC Card, format the PC Card, and remove scan data from the PC Card (2686A only)

Module Communication Dialog

You can use the Module Communication dialog to:

- View the current channel values
- View the alarm conditions

Digital I/O Points Dialog

You can use the Digital I/O Points Communication dialog to display the Digital I/O and relay status, and manually set any of the 8 relays or 20 DIO pins.

Computed Channels Dialog

You can use the Computed Channels communication dialog to perform the following tasks:

- View current values of computed channels
- View alarm conditions of computed channels

Communications Icons

The icons in the Communication window change to indicate the instrument status. Below are all the possible icons and their meaning:

Instrument Status Icon

- Yellow or blue instrument icons indicates the instrument is not connected
- Green instrument icon indicates the instrument is connected and communicating
- Red instrument icon indicates an instrument error

Module Status Icon

- Dimmed module icon indicates the module is not being scanned
- Green module icon indicates the module is being scanned
- Red module icon indicates the module is being scanned and a channel is in alarm condition

Computed Channel Status Icon

- Blue channel icon indicates channels are not being scanned
- Green channel icon indicates channels are being scanned
- Red channel icon indicates channel in an alarm condition

I/O Module 6 I/O

- Black digital I/O icon indicates all the channels are turned off.
- Green digital I/O icon indicates a channel is turned on by an external activation or by a user command
- Red digital I/O icon indicates a channel is activated by an alarm condition

Security Dialogs

You can use the system security features to protect instrument configuration information. The system security feature allows the administrator to add and remove Fluke DAQ users, allow other users to configure instruments, and to change user passwords.

Trend Dialog

You can use the Trend dialog to view the scanned data collected from the 2680 Series instruments. The charts can be On Line or Historical. You can use the Export button to export data to a .csv file that you can manipulate using Excel or other data handling software.

Alarm Dialog

You can use the Alarm View dialog to view On Line and History alarms. You can filter the alarms by instrument ID, module and channel. When an alarm occurs, the color of the instrument Icon in the communication window changes red. As long as the alarm exists, the Icon remains red. In the Alarm window, a red line of information shows the active status of the alarm. The Alarm button on the toolbar begins flashing when an alarm occurs, and continues to flash until all alarms are acknowledged.

Mail and Web Settings Dialogs

You can use the Web and Alarm Mail Settings dialog to enter Fluke DAQ web configuration information and to configure Fluke DAQ to send e-mail messages reporting alarm condition.

The Web Settings portion of dialog is used to specify a URL where scanned values from your 2680 Series instrument will be sent.

Managing Your Network Using Fluke DAQ

The following procedures provide detailed instructions for using Fluke DAQ to:

- Insert and configure instruments, modules, channels, and computed channels
- Start a scan
- View scan data
- View alarms

Inserting and Configuring an Instrument

To insert and configure a instrument

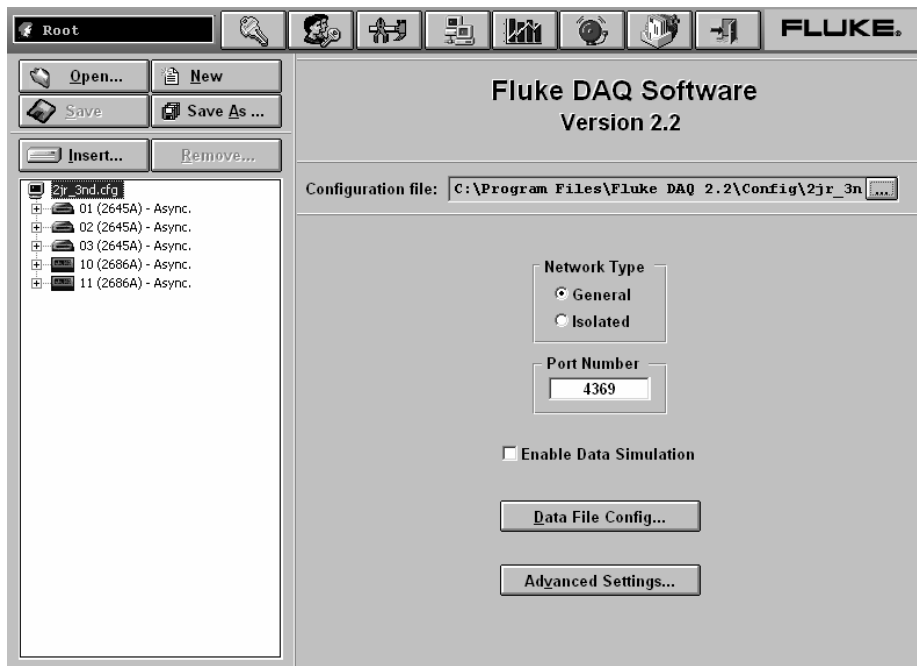

1. Double-click the  icon on your desktop to start Fluke DAQ.
2. Specify basic settings in the Fluke DAQ Application dialog.



alg102s.bmp

The dialog box entries include:

Configuration file

Click the  button or the  button to load an existing configuration file.

Network Type

Isolated if the PC is connected directly to the instrument or General if the instrument is part of a network.

Port Number

4369 is the default port number. Fluke recommends that you use the default port number.

Enable Data Simulation

If enabled, data is simulated (for demonstration purposes) and the software does not actually control the instruments.

Data File Config

Selects the Data File Configuration dialog where you can enable real-time .csv data files and configure data file groups. FlukeDAQ logs all scan data in the History database so all acquired data is saved even if no .csv file is configured. See Data File Configuration later in this chapter for more information.

Advanced Settings

Use this button to configure the following Advanced settings:

Autodisable Scan

Causes scanning to stop if the scan queue memory in the instrument fills up and there have been no communication from the computer for more than 30 seconds.

Do not ask to start slaves

Prevents Fluke DAQ from asking to start other instruments grouped with a Master when the Master starts scanning.

PAI/2640 Interval 3 and FAI/2645 Interval 3

Interval 3 is the interval the instrument checks for alarms during longer intervals between scans. You can set Interval 3 to a maximum of 1,000 seconds. The default Interval 3 value for PAI/2640 is 1 second and the minimum is 0.500 seconds. The default Interval 3 value for FAI/2645 is 0.100 seconds and the minimum is 0.050 seconds.

- To insert an instrument, select the .cfg file in the TreeView panel and click the Insert button.



alg103s.bmp

- Specify the Base Channel (1 to 99) and Instrument Type and click **Ok**. An instrument is added to the new configuration. As part of the insertion process, you must specify a base channel number. This number is used to identify the instrument and differentiate channels in different instruments. The Base Channel number auto-increments when you add instruments, or can be selected for the specific BCN of the instruments.

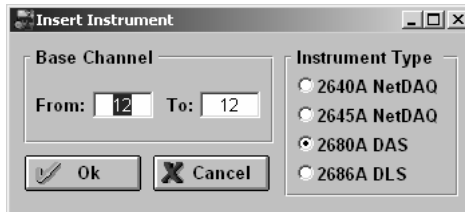

alg104s.bmp

Note

Fluke DAQ also supports 2640A and 2645A NetDAQ instruments. Some of the Fluke DAQ configuration dialogs may differ from those for the 2680 Series.

- In the TreeView panel, select the instrument you just added.



alg105s.bmp

6. Set the IP Address on the Instrument Settings dialog if using a General Network Type (IP address is disabled if you are using an Isolated Network Type) . Other fields are optional. You may need to contact your network support staff to determine the IP Address.

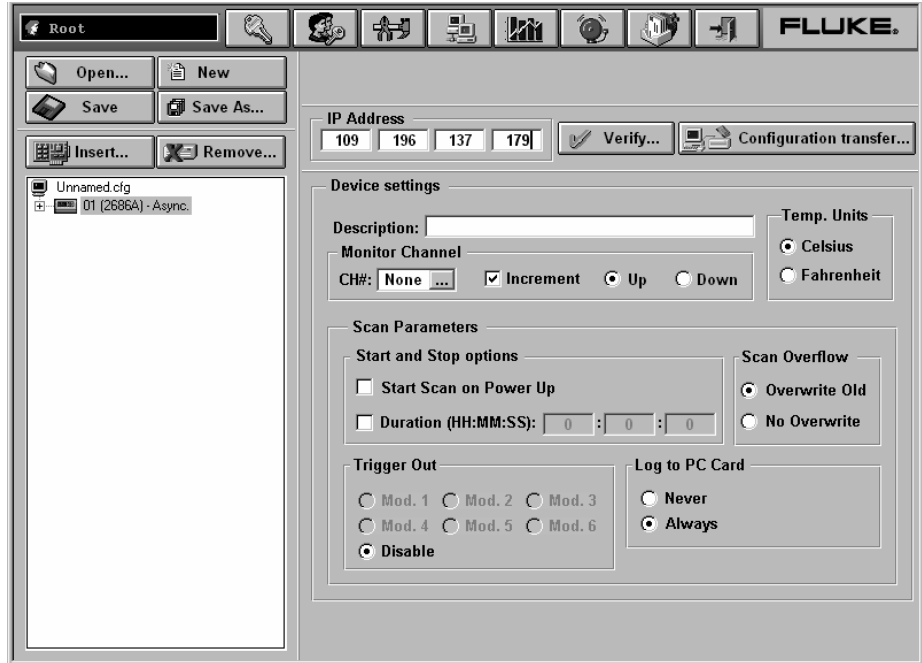

alg106s.bmp

The dialog box entries include:

IP Address

Enter the IP Address of the instrument if you are using a General Network.

Verify Button

Click the **Verify** button to ping the instrument and verify that the IP Address is correct. The instrument and your PC must both be connected to the network for this to work.

Configuration transfer

You can transfer configuration information from the PC to the instrument, from the instrument to the PC, or to and from a PC Card and the PC or the instrument. PC Card operations are available only for the 2686A.

Description

Enter a meaningful description of the instrument. 35 characters maximum.

Temperature Units

Specify Celsius or Fahrenheit. This will automatically select temperature units for all temperature measurements.

Monitor Channel

Select a channel measurement to display on the instrument front panel. You can also choose to increment up or down through all active channels automatically. Default is None.

Scan Parameters

Parameters you can set to start, stop, and save scan data. Select Start Scan on Power Up for stand-alone operation or to automatically start scanning after a power loss.

The Duration selection sets instrument to automatically stop scanning after a duration of up to 24 hours. This is a FlukeDAQ software function and is not built into the instrument. The Duration selection does not work in stand alone operation.

Note

The Scan Parameters for NetDAQ 2640A and 2645A are somewhat different and include the scan trigger and interval settings that are located in the Module Configuration dialog for the 2680 Series instruments.

Scan Overflow

You can choose to overwrite old data or stop receiving data when the buffer is full.

Log to PC Card (2686A only)

Never

Ignore the PC card.

Always

Always write to the PC card (default setting). This selection is useful for stand-alone applications or when you want data backup.

Note

When the card is full, the 2686A stops saving data to the PC card. Scanning will continue and data will be stored in the internal scan memory buffer.

Trigger Out

Used to specify a Trigger Out module. Trigger out is the physical Trigger output of an instrument. It is the Trigger Out signal out on the rear panel connector of the mainframe. If you want to set up a master/slave relationship, set a module in an instrument to control the Trigger Out signal and wire that signal to the Trigger In of all the other grouped instruments. You will then need to configure modules in the other instruments to take a reading when an External Trigger was received. The External Trigger is the same as the physical Trigger In located on the back of the mainframe.

Inserting and Configuring a Module

To insert and configure a module

1. Highlight an instrument in the TreeView panel and click the **Insert** button.

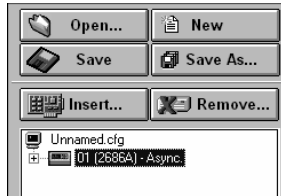

2. Specify the number and type of modules you want to insert in the Module dialog box.

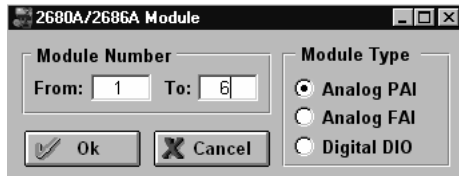

The dialog box entries include:

Module Number

You can add up to 6 modules to the 2680 Series instruments. A Digital I/O can only be inserted in Module Slot 6, and you can have only one DIO per instrument.

Module Type

Valid module types are Analog PAI, Analog FAI, or Digital DIO.

Note

The NetDAQ 2640A and 2645A do not use the Insert Module function since the 20 analog channels and 8 DIO lines are built-in and not expandable.

alg107s.bmp

alg108s.bmp

- Click **Ok**. The modules are added to the instrument and appear in the TreeView panel.

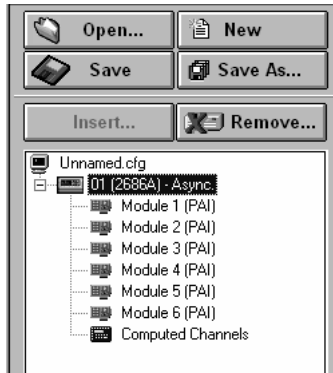

alg109s.bmp

- Select one of the analog modules you inserted and the Analog Module settings dialog appears.

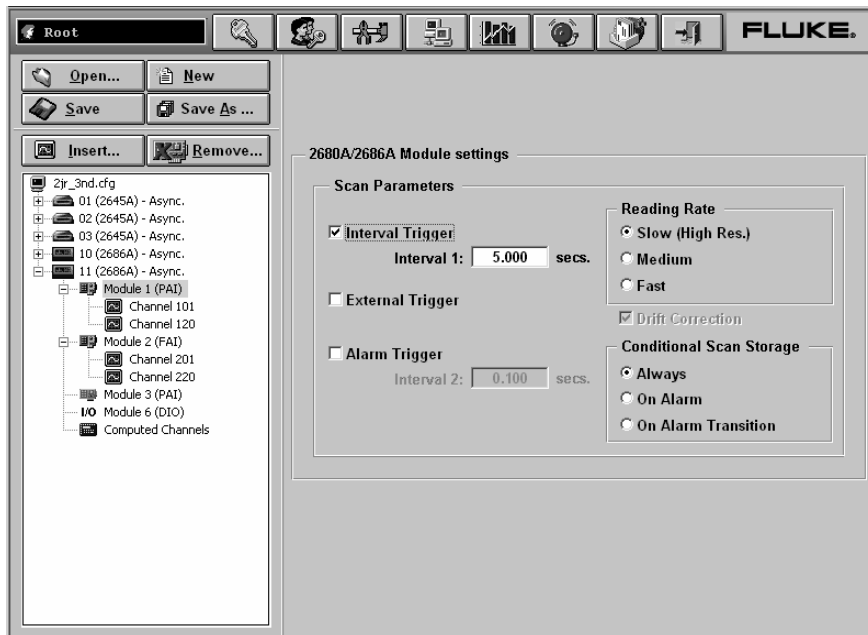

alg110s.bmp

The dialog box entries include:

Interval Trigger

Uses the interval timer (interval 1 timer) to set the scan rate for normal operation in a module. The interval is user settable.

External Trigger

Uses the Trigger input signal to start a scan. Every time the external trigger is activated, another scan is taken. If the Trigger In is held active low, scans are taken at the interval set in Interval 2.

Alarm Trigger

Uses the second interval timer (Interval 2) to start scanning when an alarm condition is encountered by the module. It continues scanning at Interval 2 as long as any channel in the instrument that is configured as an alarm trigger is in alarm.

There is also an interval timer (Interval 3) used to look for alarms during longer intervals between scans. The default for the Interval 3 timer is 0.1 s for the FAI and 1 s for the PAI. Interval 3 is set using the Advanced Settings button on the Main Configuration dialog.

Reading Rate

Select the slow reading rate for high precision or the fast reading rate for high speed. The medium rate allows resolution and speed between the slow and fast reading rates. Actual reading speed depends on the function you select.

Drift Correction

Automatically selected when you set the reading rate to Slow (High Res.) or Medium. You can click to clear the check box in fast reading rate only. Drift correction is used primarily to compensate for temperature drift. Clearing the check box allows fast scans to be taken slightly more quickly (about 1.5 ms). To maintain the specified measurement accuracy it is recommended that you DO NOT scan for long periods of time with drift correction off.

Conditional Scan Storage

Allows you to specify when to store scan data. Always is the default selection. On Alarm stores scan data as long as an alarm condition exists. On Alarm Transition stores scan data only when each alarm first occurs or ends. On Alarm Transition usually stores the least amount of data.

Note

For the NetDAQ 2640A and 2645A, the scan trigger, intervals, reading rate, and drift correction are set on the Instrument Configuration dialog instead of the Module settings dialog. Conditional scan storage is not available on the NetDAQ instruments.

If you are configuring a DIO module, the Totalizer Configuration dialog appears instead of the Module settings dialog.

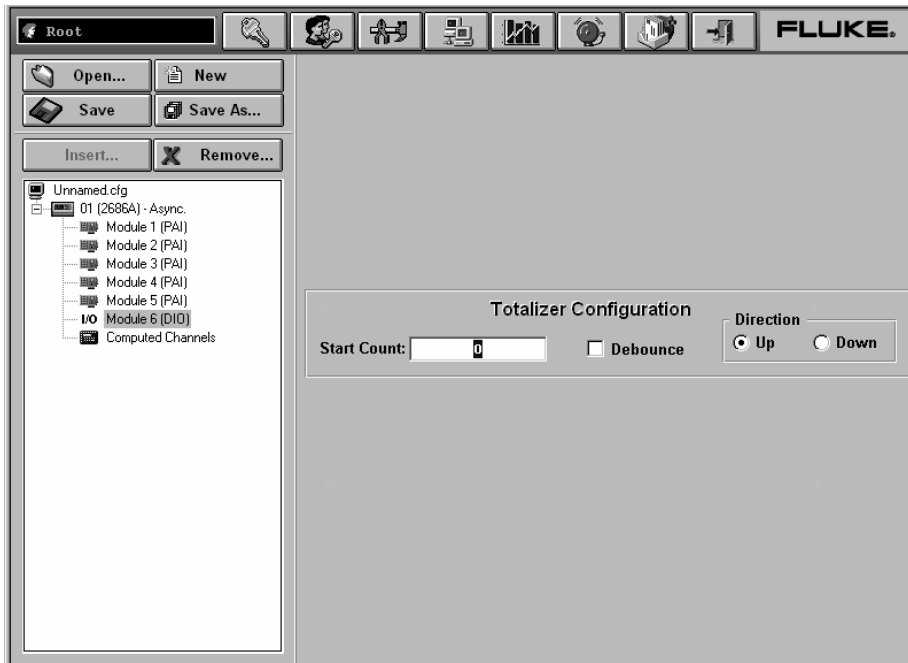

alg111s.bmp

The dialog box entries include:

Start Count

Used to specify a start count.

Debounce

Select debounce to ignore signals with a period less than 2 ms (500 Hz); otherwise, signals up to 5 kHz can be counted.

Direction

If you entered a start count, the start count is reloaded when the totalizer reaches the terminal count. The totalizer can count up or down to zero.

You can also highlight the IO module and click the  button for more DIO settings including digital IO points and relays.

Note

For the NetDAQ 2640A and 2645A, the totalizer debounce check box is set on the Instrument Configuration dialog. Totalizer start count and direction are not available on the NetDAQ.

Inserting and Configuring a Channel

After selecting a module, you need to add channels to the module.

To insert and configure a Channel

1. Highlight a module in the TreeView panel and click the **Insert** button.

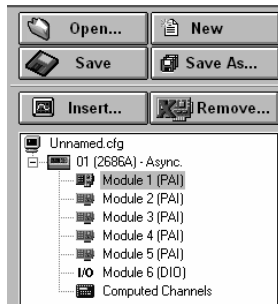

alg112s.bmp

Note

For the NetDAQ 2640A and 2645A, channels are inserted on the Instrument Configuration dialog.

2. Specify the number of channels you want to add on the Insert Channel dialog box.



alg113s.bmp

- Click **Ok**. The channels are added to the module and appear in the TreeView panel.

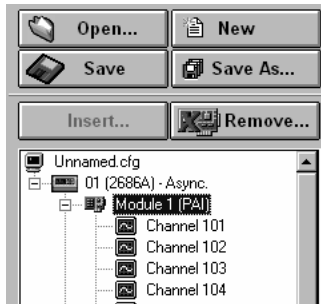

alg114s.bmp

- Select a channel and the Module settings dialog appears.

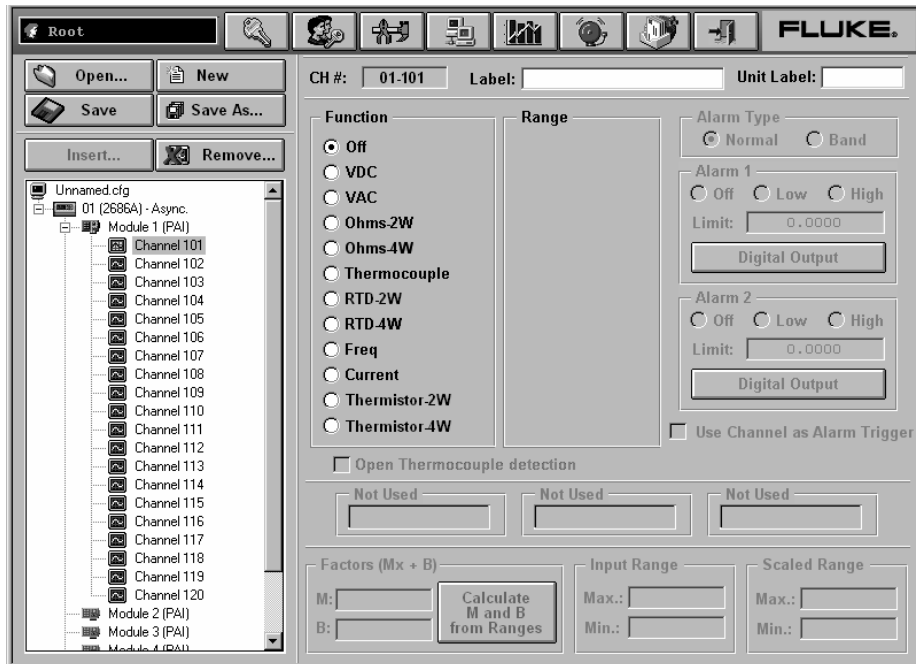

alg115s.bmp

The dialog box entries include:

CH

XX-YYY. The first two digits identify the chassis BCN (01-99). The next digit identifies the module (1-6), and the last two digits identify the channel (1-20).

Label

Use the label field to identify where the channel is used in your application.

Unit Label

Used to identify the unit of measurement (for example VDC, Ohms, Hz, °C or °F).

Function

Selects the type of measurement being performed.

Range

Amplitude range for the measurement. Use auto when you are unsure of the range.

Alarm Type

Use Normal alarm type to generate an alarm if the measurement goes above or below the Alarm 1 or Alarm 2 level. Use Band alarm type to alarm if the signal falls between two levels.

Note

The NetDAQ 2640A and 2645A instruments do not have the Band alarm type.

Alarm 1 or Alarm 2

Each channel has two alarms. You can set the alarms to Off, Low, or High. A Normal alarm condition occurs when a measurement falls below a low alarm value (Low) or rises above a high alarm value (High). A Band alarm type generates an alarm when the measurement value is between the two alarm limit values. Fluke DAQ records all alarm conditions in an alarm database.

Each of the two Alarm limits (one for the Band type alarm) has a Digital Output button to select Digital or relay outputs that go active when an alarm is generated from the alarm limit. Use Channel Alarm Trigger Select if channel reading will be used to provide alarm trigger.

Open Thermocouple Detection

Provides for notification if an open thermocouple is detected.

Factors (Mx+B)

Used to scale measurements with a slope-intercept linear equation. $Mx + B$ scaling multiplies a measurement by a multiplier (M) and then applies an offset (B). For example, $Mx+B$ scaling of $100x+50$ applied to a measured value of 1.15 would result in a reading of $100(1.15)+50=165$.

Input and Scaled Range

You can enter the Input and Scaled ranges and click the **Calculate M and B from Ranges** button to have and Fluke DAQ calculate the M and B values.

Configuring a Computed Channel

Computed channels provide a means to calculate values based on measurements. For example, if Channel 1 measures dc V and Channel 2 measures dc I, you could use a computed channel to calculate instantaneous power (Channel 1 x Channel 2).

For a computed channel to execute, it must be associated with the scanning of a module. You must choose at least one module in the Scan with Module area for this association. The default is module 1.

To configure a computed channel

1. Highlight the Computed Channels icon in the TreeView panel and click the **Insert** button.

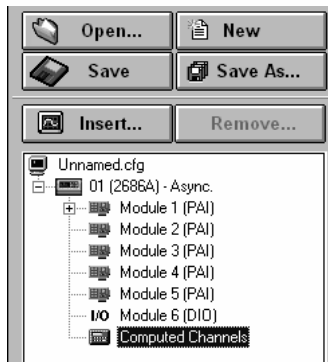

alg116s.bmp

2. Specify the number of the channels you want to insert on the Insert Channel dialog box.

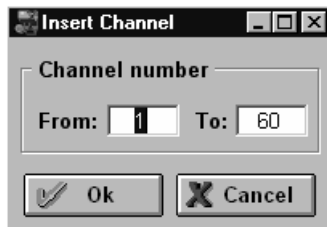

alg117s.bmp

- Click **Ok**. The computed channels are added and appear in the TreeView panel.

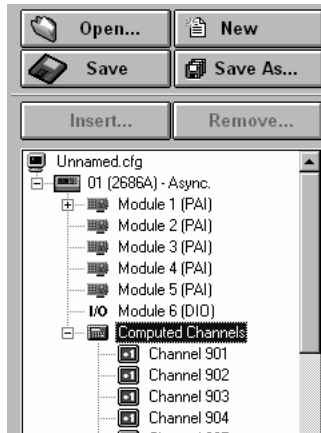

alg118s.bmp

- Select a computed channel and the Computed Channel settings dialog appears.

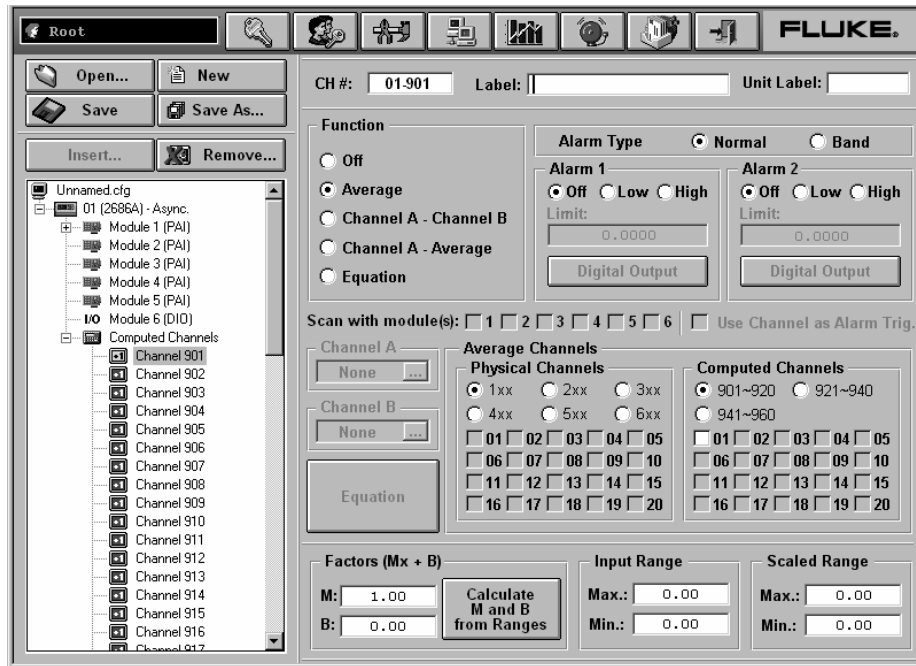

alg119s.bmp

The dialog box entries include:

CH #

Computed channels in the 2680 Series are assigned channel numbers from 901 to 960. Computed channels in the NetDAQ are numbered 21-30.

Label

Use the label field to identify where the computed channel is used.

Unit Label

Used to identify the unit of measurement (for example VDC, Ohms, Hz, °C or °F).

Function

You can take the average of readings from multiple channels, subtract the measurement of one channel from the measurement of another channel or an average, or generate an equation based on measurements.

Alarm Type

Use Normal alarm type to generate an alarm if the measurement goes above or below the Alarm 1 or Alarm 2 level. Use Band alarm type to alarm if the signal falls between two levels.

Note

The NetDAQ 2640A and 2645A instruments do not have the Band alarm type.

Alarm 1 or Alarm 2

Each channel has two alarms. You can set the alarms to Off, Low, or High. A Normal alarm condition occurs when a measurement falls below a low alarm value (Low) or rises above a high alarm value (High). A Band alarm type generates an alarm when the measurement value is between the two alarm limit values. Fluke DAQ records all alarm conditions in an alarm database.

Each of the two Alarm limits (one for the Band type alarm) has a Digital Output button to select Digital or relay outputs that go active when an alarm is generated from the alarm limit. Use Channel Alarm Trigger Select if channel reading will be used to provide alarm trigger.

Digital Output

Used to output a digital signal or close a relay if an alarm is detected.

Use Channel as Alarm Trigger

Select if channel reading will be used to generate an alarm trigger.

Scan With Modules

Calculate the computed channel any time the selected modules are scanned.

Channel A or Channel B

Select from the configured channels in the instrument for difference functions.

Note

You cannot select channels in another instrument.

Equation

Computed channel equations are described in Using Equations with Computed Channels later in this chapter. See Appendix E for detailed information.

Average Channels

Select which channels you want to average. You can select any configured channel on any module in the instrument as well as any configured computed channels.

Factors (Mx + B)

Used to scale measurements with a slope-intercept linear equation. Mx + B scaling multiplies a measurement by a multiplier (M) and then applies an offset (B). For example, Mx+B scaling of 100x+50 applied to a measured value of 1.15 would result in a reading of 100(1.15)+50=165.

Input or Scaled Range

You can enter the Input and Scaled range and press the Calculate M and B from Ranges button to have Fluke DAQ calculate the M and B values.

Configuring Multiple Channels

You can change or set configurations using multiple selections in the TreeView window. The screen that displays when a multiple selection is made has controls that assume the values of the lowest selected node. Fluke DAQ considers the lowest node the one that has the lowest number between the selected nodes. When the other selected nodes have data that differ, the controls on the dialog assume a different state. The table below lists the controls and their possible states:

Table 3-2. Configuration Control States

Control Name	Configuration State		
	Same Set	Same Unset	Different
Text Box	<input type="text" value="Text"/>	<input type="text" value="Text"/>	<input type="text"/>
Combo Box	<input type="text" value="Select"/>	<input type="text" value="Select"/>	<input type="text"/>
Check Box	<input checked="" type="checkbox"/>	<input type="checkbox"/>	<input checked="" type="checkbox"/>
Option Button	<input checked="" type="radio"/>	<input type="radio"/>	<input checked="" type="radio"/>

Using Equations with Computed Channels

If you select the Computed Channel Equation function, and press the Equation button, the Expression entry dialog appears.

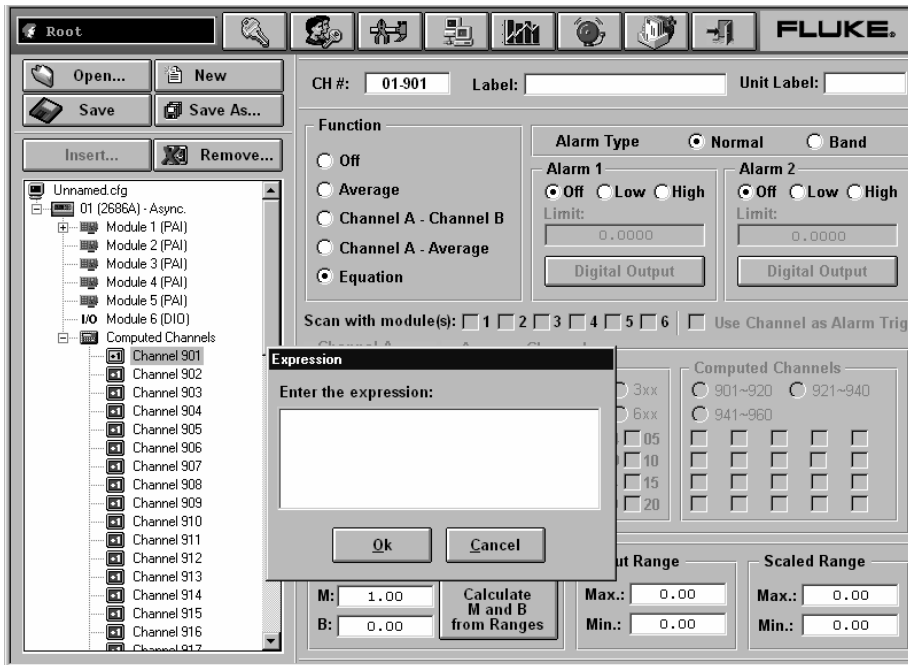

alg120s.bmp

The following is a list of the valid notations in an expression.

Axxx Alarm on/off (Boolean value of 1 or 0)

Cxxx Any channel measurement

C9xx Computed channel

TS Time since last measurement (milliseconds)

TOT Totalizer

Operators +, -, *, /, **, unary +, unary -, abs, exp, int, ln, log, and sqrt

Operators Values in integer, floating point or scientific notation (for example, 1 -2.345 +6.7890E-03)

Each computed channel can have an expression of up to 250 characters but the total maximum number of characters available in all 60 channels is limited to 6,000 characters.

Every expression must refer to at least one channel or other measurement value such as TOT. For example, the expression C101+1 adds one to the measured value of channel 101, while C102**2 produces the square of the channel 102 value. Expressions can refer to multiple channels, such as C201*C202, which multiplies the channel 201 value by channel 202; if C201 is measuring voltage and C202 current, this calculated the power.

More complex calculations can be done as well, including calculations using or done over time. For example, you could use an equation to calculate the rate of flow in gallons per second. The rate of flow could be calculated as follows. Since TS is in milliseconds, you need to divide by 1000 to calculate gallons per second. In this example, during the first pass, C902 will not be defined and the result will be not a number (#Inf). However, in subsequent passes, C902 will be defined and will provide the correct result.

C101 = some other measurement to force the time calculation
 C901 = (TOT-C902)/(TS/1000)
 C902 = TOT

Note

You need one physical channel configured in the module that you're scanning for this to work even though you're not using the channel in the expression.

Computed channels and the time value are initialized to zero at the beginning of scanning. Physical channels that haven't been measured are still initialized to positive infinity.

To measure the total energy used by a simple system, a calculation could be generated using the equation, energy = R x I² * time, as follows:

C101 = [Ohms]
 C102 = [Current]
 C959 = C101*C102**2*TS/1000
 C960 = C959+C960

Note

This equation assumes that the resistance and current are constant for the duration of the time interval. It also does not calculate the energy used in the first increment of time.

In this example, C960 refers to itself. By doing this, it gets the value of C960 from the previous scan, which allows it to calculate the total of all its values since scanning started. In the same way, referring to a higher number channel in a computed channel will get the value of that channel from the previous scan.

Starting a Scan

You can scan for data using a configuration scan to start an individual instrument or all instruments. The Spy function allows readings to be taken and displayed in the software without starting scanning. All scanning options are available in the Communication window.



Note

You must have channels configured for operation before starting a scan. You cannot change the instrument configuration while the instrument is scanning.

You can enter the configuration screen while scanning. From the Configuration Screen, you can see the configuration of all the instruments, but can only change the configurations of instruments that are not scanning.

Starting a Configuration Scan

To start a configuration scan

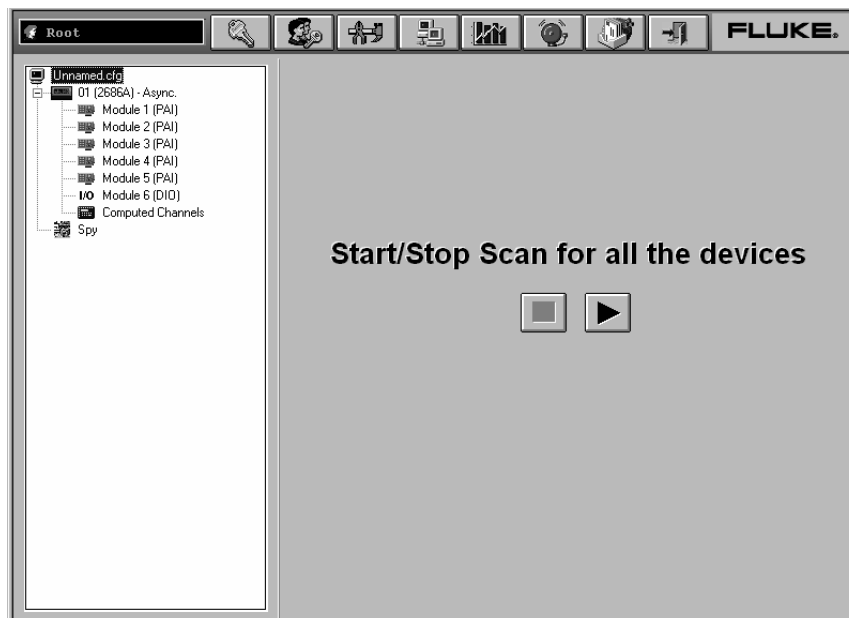

1. Click the  on the Fluke DAQ toolbar and highlight the top or root item in the TreeView panel.
2. Click  to start the scan on all instruments. Click  to stop the scan.



alg121s.bmp

Starting an Instrument Scan

To start an instrument scan

1. Click the  on the Fluke DAQ toolbar and highlight a instrument in the TreeView panel.
2. Click  to start the scan. Click  to stop the scan.

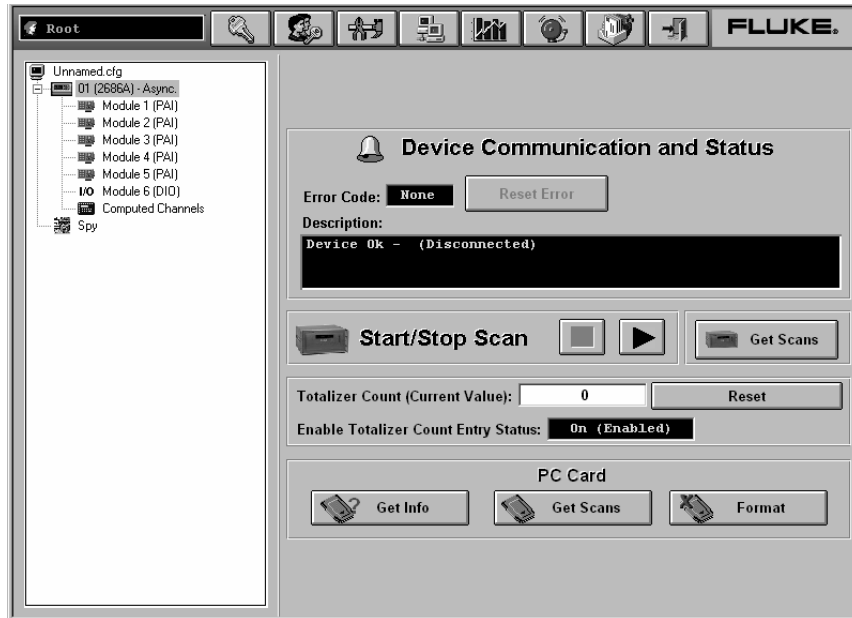

alg122s.bmp

Getting Scan Data

Click the  button to retrieve any scans in the instrument's memory. The scan data is retrieved and logged into the history database where it can be viewed in the Trend window and exported if desired.

If scanning is started from Fluke DAQ, the software automatically retrieves the scan data and logs it in the history database until scanning is stopped or until the software stops running. There is no need to retrieve the scan data manually. However, if scanning is started from the 2680A or 2686A front panel or if scanning continues after the software or computer is shut down, the scan data is stored in the instrument's internal scan queue memory. Get Scan can be used in these cases to retrieve scan data from the instrument and clear it from memory.

Viewing and Resetting the Totalizer

The Totalizer Count current value on the Instrument communication screen is updated after each scan. Press the  to set the totalizer to zero or to the start count value set in the totalizer configuration.

PC Card Functions

If the instrument is a 2686A model, the PC Card buttons are present on the Instrument Communication screen. The buttons provide functions to get information about the PC card, get scan data from the card, or format the card.

Getting PC Card Information

Click the  button to get information about the PC card in the 2686A card slot. The Get Info function provides information on the size of the card, the amount of free space, the amount of space used for both stored configuration and data, and the number of scans stored on the card.

Formatting the PC Card

Click the  button to format the PC Card in the 2686A card slot. A dialog box will ask if you are sure you want to format the PC Card. Click Yes to format the card, which clears the PC Card in the 2686A card slot and makes it ready to use.

Getting PC Card Scan Data

Click the  button to open the PC Card Data File Configuration dialog shown below. This can only be done when the 2686A instrument is not scanning.

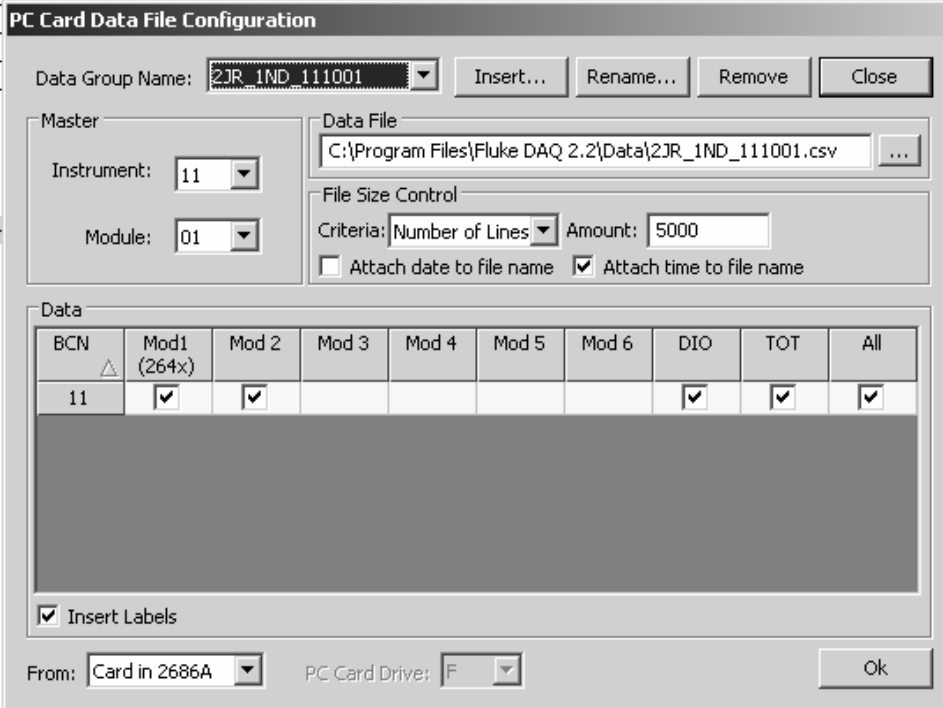

The dialog box is titled "PC Card Data File Configuration". It contains the following elements:

- Data Group Name:** A dropdown menu showing "2JR_IND_111001". Buttons for "Insert...", "Rename...", "Remove", and "Close" are to its right.
- Master Section:**
 - Instrument:** A dropdown menu showing "11".
 - Module:** A dropdown menu showing "01".
- Data File:** A text field containing "C:\Program Files\Fluke DAQ 2.2\Data\2JR_IND_111001.csv" with a browse button "...".
- File Size Control:**
 - Criteria:** A dropdown menu showing "Number of Lines".
 - Amount:** A text field containing "5000".
 - Two checkboxes: "Attach date to file name" and "Attach time to file name".
- Data Table:** A table with columns: BCN, Mod1 (264x), Mod 2, Mod 3, Mod 4, Mod 5, Mod 6, DIO, TOT, All. The first row has values: 11, [checked], [checked], [empty], [empty], [empty], [empty], [checked], [checked], [checked].
- Insert Labels:** A checkbox that is checked.
- From:** A dropdown menu showing "Card in 2686A".
- PC Card Driver:** A dropdown menu showing "F".
- Ok** button.

alg166s.bmp

If necessary, create a Data Group to save the data or use one of the other Data Groups already created in the configuration screen. After making all other settings, select From: Card in 2686A if the PC Card is in the slot in the 2686A unit, or From: Card in PC and the correct drive letter if it is in a PC Card slot or memory card reader on the PC.

The Data Group, Master, Data File, and Data Settings work the same as with the Advanced Data File Configuration described in this chapter, except that only this single 2686A unit is shown. If Insert Labels is used, the configuration in Fluke DAQ for this instrument needs to be the same as the configuration of the 2868A when the scan data was collected, or the labels may not be correct.

When you click the **Ok** button, Fluke DAQ will try to create the data file. When creating the file, if Fluke DAQ detects a file on disk with the same name that Fluke DAQ is trying to generate, Fluke DAQ will add data to the file or rename it depending on the File Size Control configuration. After the scans are retrieved from the PC Card, the dialog will close. The Get Scans function does not erase the scan data from the PC Card, so you can perform the PC Card Get Scans multiple times with different combinations of module data if you choose.

⚠⚠ Caution

Changes made to any Data Group on this dialog will remain as if changed in the Configuration Section.

Starting Spy

Spy triggers and collects its own measurements from up to eight channels from any combination of instruments. The data is not stored and the instruments you are checking do not need to be scanning.

To start a Spy

1. Click the  on the Fluke DAQ toolbar. The Spy icon appears in the lowest item in the TreeView panel.
2. Click the Spy icon and the Spy window appears. You may select up to 8 channels, including DIO, relays, and totalizer values.

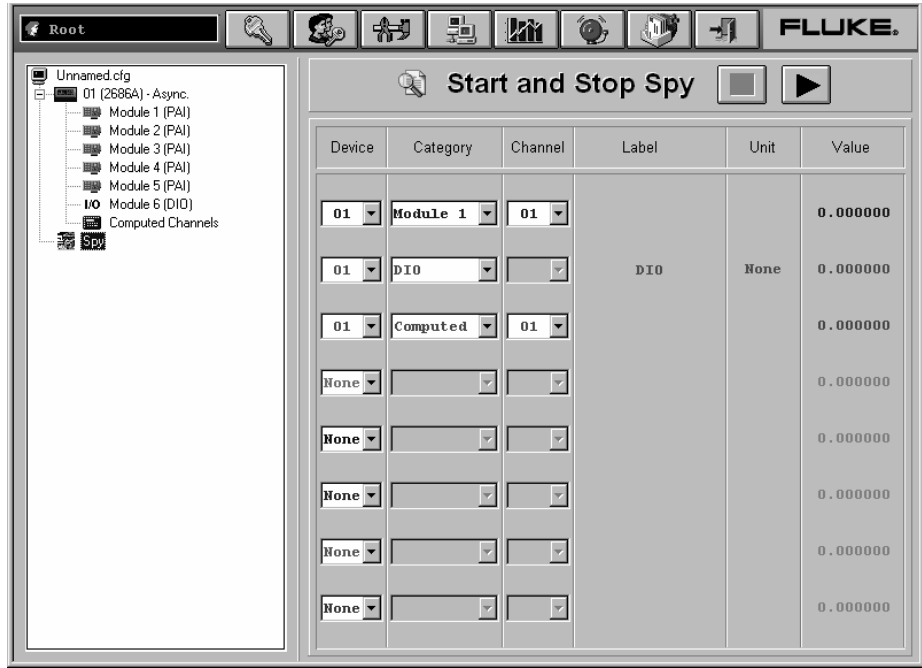

alg123s.bmp

3. Click  to start Spy. Click  to stop Spy.

Viewing Module Measurement Data

You can view measurement data from a module as it is recorded. Selecting a module shows all 20 channels. Selecting the Computed Channels shows the 60 computed channels. Modules that are not scanning display question marks for the channels. NC indicates that a channel is not configured.

To view module measurement data

1. Click the  on the Fluke DAQ toolbar.
2. Highlight a module in the TreeView panel and the module measurement data appears.

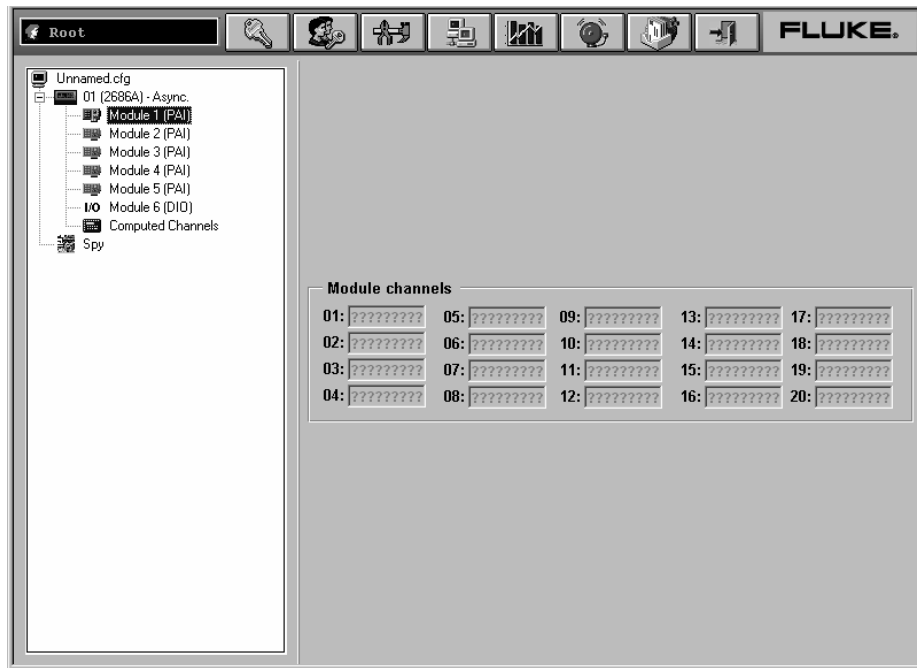

alg124s.bmp

Note

For the NetDAQ 2640A and 2645A, the physical input channels and computed channels are shown on the device communication screen instead.

Using the Digital I/O Points Communication Dialog

You can use the Digital I/O Points Communication dialog to set any of the 8 relays or 20 DIO pins. You can also view status of all of the relays and DIO pins and set or clear IO bits and relays. Bits or relays you set display a green dot. Bits or relays set by an alarm have a red dot. A bit set by an external signal has a blue dot. There is no way to set a relay externally. When a relay is set, it has closed contacts. When a bit is set, it has a logic low signal (also called active low).

To view digital I/O points dialog

1. Click the  on the Fluke DAQ toolbar.
2. Highlight an I/O module in the TreeView panel and the Digital I/O Points dialog appears.

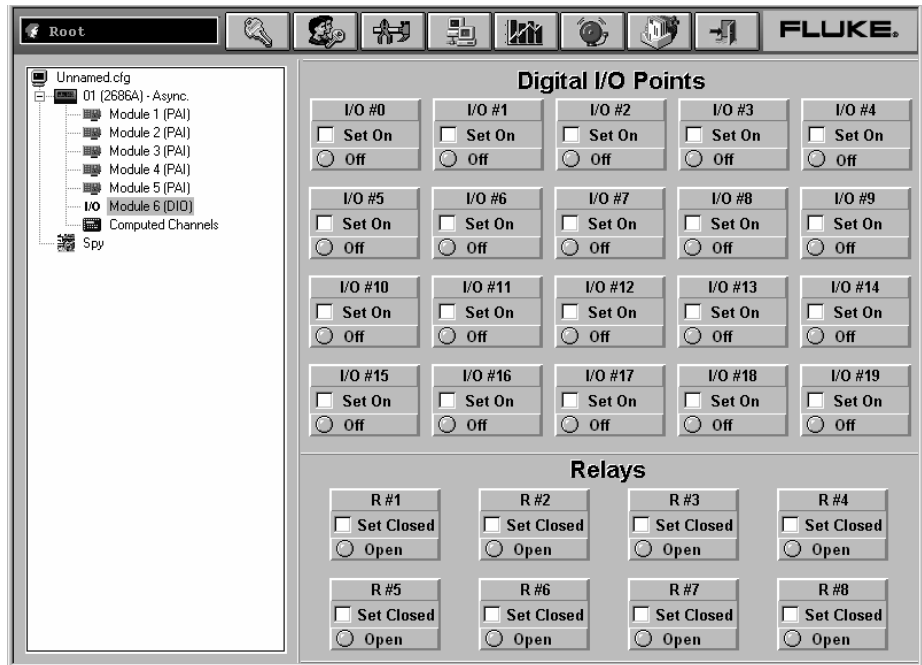

alg125s.bmp

Note

The NetDAQ 2640A and 2645A have only 8 DIO lines.

Using Trend to View Collected Data

You can use the Trend dialog to view the scanned data collected from the 2680 Series or NetDAQ instruments. The charts can be On Line or Historical. You can use the Export button to export data to a .csv file that you can manipulate using Excel or other data handling software.

You can select up to eight channels to view on the Trend chart. If a particular channel is not active, question marks are displayed. A moveable, horizontal cursor is used to find the time a signal reached a certain amplitude. Use the <CTRL><ALT><Print Screen> the key combination to copy a bit map of the chart and paste it to a word processing document. If an instrument is stopped, the data for all channels in that instrument that are also shown in the Trend window are replaced with ???????. Channels that are still scanning will continue to show the latest data.

To use the trend feature

1. Click the  button on the Fluke DAQ toolbar and the Trend dialog appears.

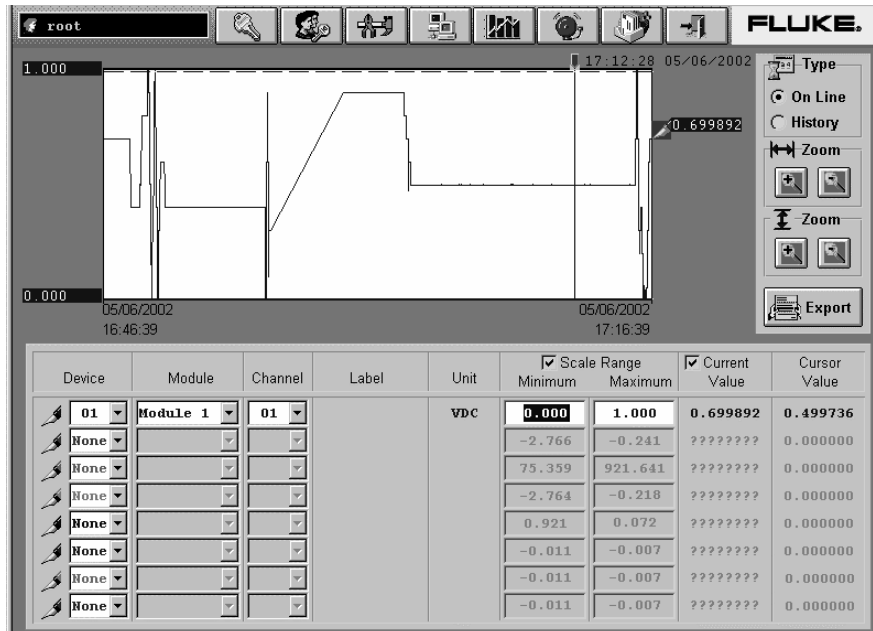

alg126.bmp

The dialog box entries include:

Type

Specify On Line or History scan view. History view shows the last set of data displayed with the pens.

Zoom

Use  Zoom to expand or compress the time interval you are viewing.

Use  Zoom to increase or lower the amplitude resolution.

Scale Range

Select the Scale Range check box to display the scales for all the trends on the left side of the chart.

Current Value

Select the Current Value check box to display a colored pen symbol and the current value for each trend on the right side of the chart.

Each channel set up to display on the Trend chart has the following properties.

- Instrument is the BCN of the instrument for the channel
- Module selects the module number or the computed channels
- Channel is actual channel to display for the trend line
- Label is the description for the channel
- Units is the measurement units for the channel
- Minimum level is at the bottom of the chart for that trend
- Maximum level is at the top of the chart for that trend
- Current value is the value of the channel at the time shown on the right edge of the chart
- Cursor value is the value at the position of the moveable cursor for the channel

Export

Click the **Export** button to open the Export Data Group Configuration dialog shown below.

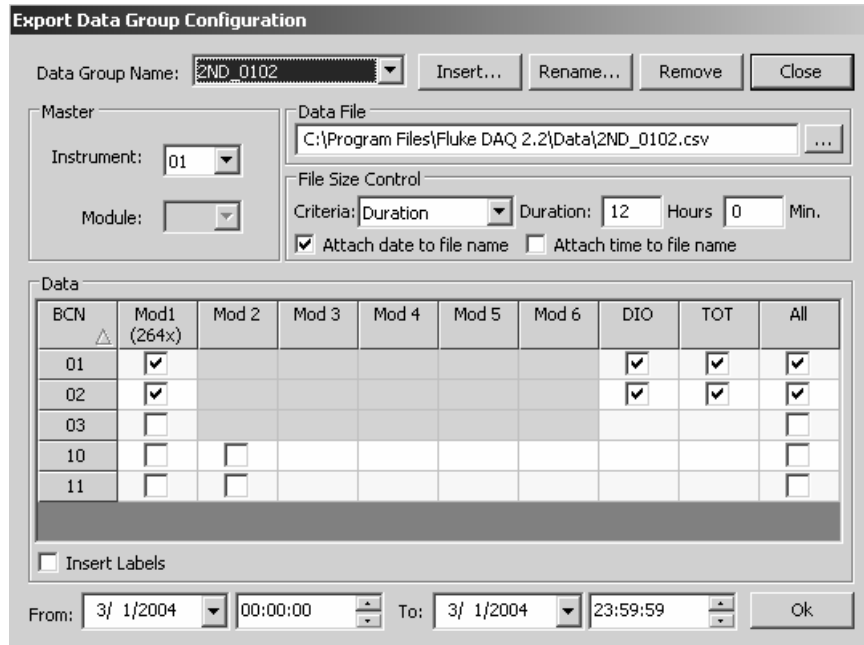

The dialog box is titled "Export Data Group Configuration". It contains the following elements:

- Data Group Name:** A dropdown menu showing "2ND_0102". Buttons for "Insert...", "Rename...", "Remove", and "Close" are to its right.
- Master Section:**
 - Instrument:** A dropdown menu showing "01".
 - Module:** An empty dropdown menu.
- Data File:** A text field containing "C:\Program Files\Fluke DAQ 2.2\Data\2ND_0102.csv" with a browse button "...".
- File Size Control:**
 - Criteria:** A dropdown menu showing "Duration".
 - Duration:** Input fields for "12" Hours and "0" Min.
 - Checkboxes for "Attach date to file name" (checked) and "Attach time to file name" (unchecked).
- Data Table:** A table with columns: BCN, Mod1 (264x), Mod 2, Mod 3, Mod 4, Mod 5, Mod 6, DIO, TOT, and All.

BCN	Mod1 (264x)	Mod 2	Mod 3	Mod 4	Mod 5	Mod 6	DIO	TOT	All
01	<input checked="" type="checkbox"/>						<input checked="" type="checkbox"/>	<input checked="" type="checkbox"/>	<input checked="" type="checkbox"/>
02	<input checked="" type="checkbox"/>						<input checked="" type="checkbox"/>	<input checked="" type="checkbox"/>	<input checked="" type="checkbox"/>
03	<input type="checkbox"/>								<input type="checkbox"/>
10	<input type="checkbox"/>	<input type="checkbox"/>							<input type="checkbox"/>
11	<input type="checkbox"/>	<input type="checkbox"/>							<input type="checkbox"/>
- Insert Labels:** A checkbox that is currently unchecked.
- From:** Date and time fields showing "3/ 1/2004" and "00:00:00".
- To:** Date and time fields showing "3/ 1/2004" and "23:59:59".
- Buttons:** "Ok" and "Close" buttons.

alg145s.bmp

If necessary, create a Data Group to export data or use one of the other Data Groups already created in the configuration screen. After making all other settings, enter the From: and To dates and times to specify the period of time of the data to export.

The Data Group, Master, Data File, and Data Settings work the same as the with the Advanced Data File Configuration described later in this chapter.

When you click the **Ok** button, Fluke DAQ will try to create the data file. When creating the file, if Fluke DAQ detects a file on disk with the same name that Fluke DAQ is trying to generate, Fluke DAQ will add data to the file or rename it depending on the File Size Control configuration. After the export is complete, the Export dialog will close.

⚠⚠ Caution

Changes made to any Data Group on this Dialog will remain as if changed in the Configuration Section.

Changing the Trend Chart Display

To change the Trend chart display

- The Trend Setting dialog appears when you double-click on the chart screen. Use the Trend Settings dialog to change the location of the upper and lower boundary points and the scaling seen on the chart for each of the plot pens you are using.

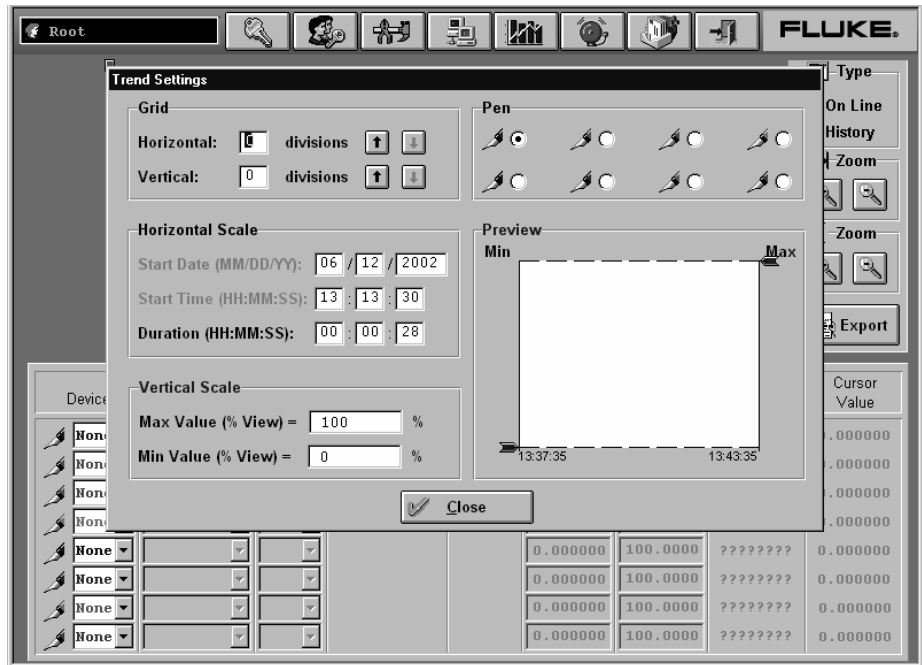

alg128s.bmp

Viewing Alarms

You can use the Alarm View dialog to view On Line and History alarms. You can filter the alarms by instrument BCN, module and channel. When an alarm occurs, the color of the instrument icon in the communication window changes to red. As long as the alarm exists, the icon remains red. In the Alarm window, a red line of information shows the active status of the alarm. The Alarm toolbar button begins to flash when an alarm occurs, and continues flashing until all alarms are acknowledged.

If the alarm condition goes away before you acknowledge the alarm, the alarm line changes to blue. When you acknowledge an alarm, it turns green. All alarm conditions are recorded in the Alarm History dialog. If an alarm appears in red in the Alarm History dialog, it will not be duplicated. If an alarm is active, it must be acknowledged before it will be displayed again. When a channel has two alarms, only one alarm can be active at a time. If one alarm becomes active and then a second alarm becomes active, Fluke DAQ will acknowledge the first alarm and show the second alarm as active.

To view alarms

- Click the  button on the Fluke DAQ toolbar and the Alarm View dialog appears.

When you select the On Line option, a red line of text with information about the alarm is printed to the screen when a new alarm is detected.

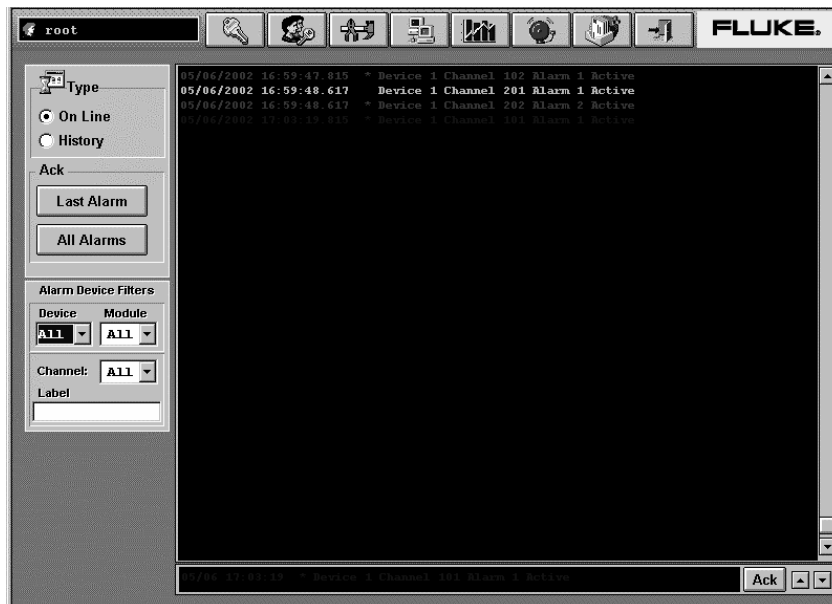

The dialog box entries for On Line include:

Type

Specify On Line or History alarm view.

Ack

Click the appropriate button to acknowledge the Last Alarm or All Alarms.

Alarm Instrument Filters

Choose to view alarms from a select set of instruments, modules, and channel.

When you choose the History option, you can view alarms over a period of time. Each time an alarm changes state the new color is added to the history screen. You can view alarms that have occurred over a period of time or for a specific instruments, modules, or channels.

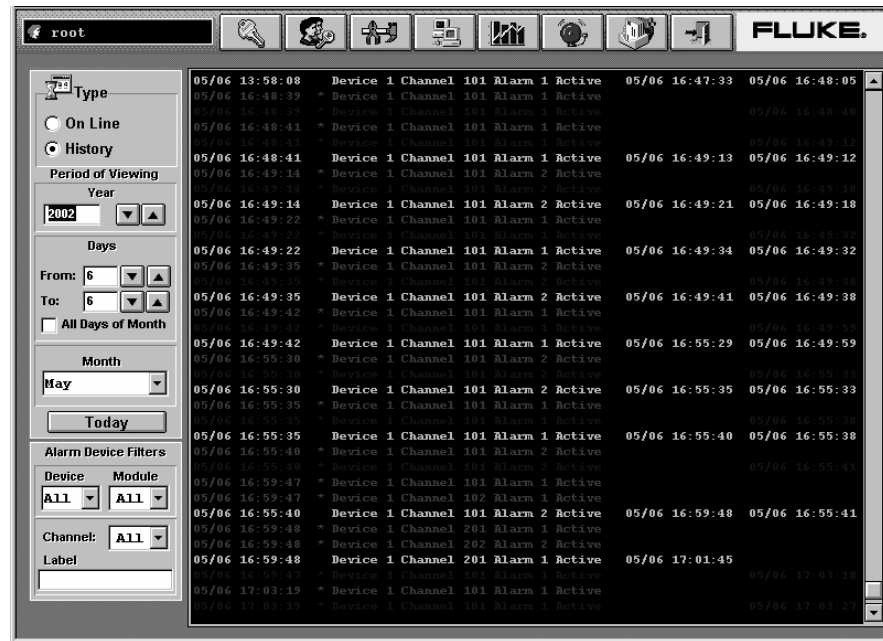

alg130.bmp

The dialog box entries for History include:

Type

Specify On Line or History alarm view.

Period of Viewing

Specify the year, day(s), and month that want to view.

Alarm Instrument Filters

Choose to view alarms from a select set of instruments, modules, and channel.

Configuring Data Files

You can use the interface for real-time data files generation to merge data from multiple modules, even if they are in different instruments.

To use the Data File Configuration feature

- Click the **Data File Config...** button on the Fluke DAQ main window and the following dialog appears.

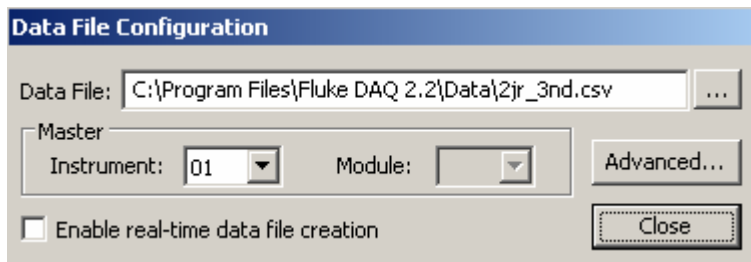

alg153s.bmp

The dialog box entries include:

Data File

Name of the data file that will be generated. The default value for this field is “C:\Program Files\Fluke DAQ 2.2\Data\[Configuration Name].csv”.

Master Instrument

Defines the instrument used as master when generating the data file.

Master Module

When the selected master is a 2680 Series instrument, you need to define the master module as well.

Enable real-time data file creation

Check this option to create an Excel compatible .csv data file when you start scanning the master instrument. If this option is not selected, no .csv data file will be created. Remember that Fluke DAQ stores the scan data in a history database for any instrument enabled in the system, even if a real-time .csv data file is not enabled. The data in this database may be exported to an Excel compatible file in the Trend window.

By default, Fluke DAQ adds all data from all the instruments into a single .csv data file when real-time data file creation is enabled. Use the Advanced Data File Configuration feature if you don't want to save all the data, or want to split the data into different data files.

Selecting a Master for a Data Group

The scan timestamps of the instrument and module selected as the Master are used to determine the time for each scan in the .csv data file. This is necessary when you merge scan data from multiple instrument and module sources because the timestamps from these different sources may not be exactly the same.

Scans from other sources are grouped with the matching master scan data. If all instruments and modules have the same scan interval, it should not matter which source is used as the Master, except that the data from the Master will be in the first columns of the .csv file. When actual scan intervals differ between sources, the scan data is handled as follows:

- If an instrument or module scans slower than the Master, that slower source's data is repeated in the .csv file until a new scan is received from the slower source.
- If an instrument or module scans faster than the Master, only the scans from the faster source that match the time of a Master scan are saved to the merged .csv file.

Advanced Data File Configuration

Use the Advanced Data File Configuration dialog to create multiple groups of data files. The configuration performed in the Data File Configuration window is stored in the group that has the same name as the Fluke DAQ configuration file.

To use the Advanced Data File Configuration feature

- Click the **Advanced...** button on the Data File Configuration dialog and the Advanced Data File Configuration dialog appears.

Advanced Data File Configuration

Data Group Name: 2jr_3nd **Insert...** Rename... Remove Close

Master
Instrument: 01
Module:

Data File
C:\Program Files\Fluke DAQ 2.2\Data\2jr_3nd.csv ...

File Size Control
Criteria: None
 Attach date to file name Attach time to file name

BCN	Mod1 (264x)	Mod 2	Mod 3	Mod 4	Mod 5	Mod 6	DIO	TOT	All
01	<input checked="" type="checkbox"/>						<input checked="" type="checkbox"/>	<input checked="" type="checkbox"/>	<input checked="" type="checkbox"/>
02	<input checked="" type="checkbox"/>						<input checked="" type="checkbox"/>	<input checked="" type="checkbox"/>	<input checked="" type="checkbox"/>
03	<input checked="" type="checkbox"/>						<input checked="" type="checkbox"/>	<input checked="" type="checkbox"/>	<input checked="" type="checkbox"/>
10	<input checked="" type="checkbox"/>	<input checked="" type="checkbox"/>					<input checked="" type="checkbox"/>	<input checked="" type="checkbox"/>	<input checked="" type="checkbox"/>
11	<input checked="" type="checkbox"/>	<input checked="" type="checkbox"/>					<input checked="" type="checkbox"/>	<input checked="" type="checkbox"/>	<input checked="" type="checkbox"/>

Insert Labels

Enable real-time data file creation

alg141s.bmp

The dialog box entries include:

Data Group Name

Name of the current active group. This box can be used to show any group names used with the configuration by selecting the down arrow.

Insert

Inserts a new group. Click the  button and the New Group dialog appears.

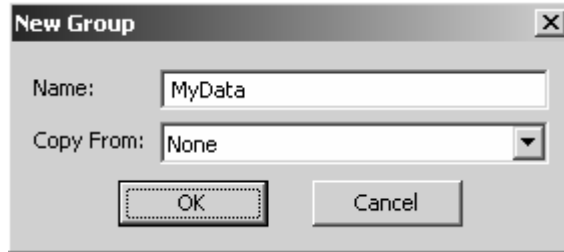

alg142s.bmp

Name:

Group name. The default name is MyData. If you create a group with the name MyData, the name MyData1 will be suggested as the next name. The number that follows the name will increase until a unique number is found.

Copy From:

Specifies if the group will be created using the default values (None) or the values from another group (any other text selected in the Combo-Box).

OK

Inserts the new group.

Cancel

Closes the window without inserting a new configuration.

Note

Fluke DAQ displays an error message if the you enter the name of an existing group or a blank name.

Rename

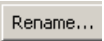
Click the  button to change the name of an existing data group. When you click the Rename button, the Rename Group dialog appears.

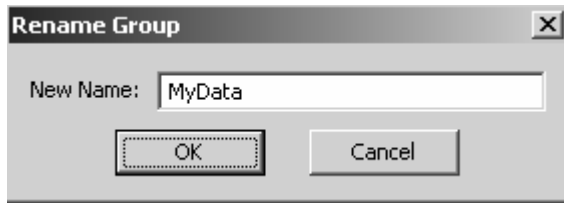

alg143s.bmp

Note

Fluke DAQ displays an error message if the you enter the name of an existing group or a blank name.

Remove

Click the button to remove an existing group (only the group is deleted, any data file created by the group remains). When you click this button, a confirmation box appear. Click **Yes** to confirm the removal or **No** to cancel.

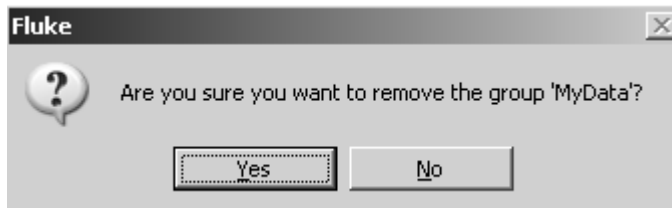

alg144s.bmp

Master Instrument:

Defines the instrument used as master when generating the data file. Only one master instrument per group is allowed. Data from other modules is aligned to the master.

Master Module:

When the selected master is a 2680 Series instrument, you need to define the master module as well.

Data File

Specify the name of the data file that will be generated. The default value for this field will be "C:\Program Files\Fluke DAQ 2.2\Data\[Group Name].csv".

File Size Control

The File Size Control provides a way to limit the size of the .csv data files using several criteria. When the selected criterion is reached, Fluke DAQ will "roll over" the data file, in other words it automatically closes and renames the current .csv file, and creates a new data file with the original name.

File Size Control allows you to select from the follow in criteria (see Table 3-3 for details):

Time of day

The hour and minute that the file name rolls over.

Duration

The length of time that data will be stored in a file before the file name rolls over.

File size

The number of Megabytes that will be stored in a file before the file name rolls over.

Number of Lines

The number of scans that will be placed in the file before the file name rolls over.

File Size Control also offers several options for renaming the data file, as described below.

Attach date to file name

Attach the date of the file roll over in _YYYYMMDD (YYYY – Year, MM – Month, DD – Day) format to the file name.

Attach time to file name

Attach the time of the file roll over in _HHMMSS (HH – Hour, MM – Minute, SS – Second) format to the file name.

If another file with the same ‘rename’ name exists or if no Attach option selected, a _Number is attached to the file. The value for Number is incremented up to form a file name that does not exist. After renaming the file, Fluke DAQ creates a new data file with the original data file name.

For example, when the specified file size control criterion is reached, the file “MyData.csv” is renamed as shown in Table 3-3.

Table 3-3. File Renaming Example

Attach Date	Attach Time	New File Name
Disabled	Disabled	C:\MyData_1.csv
Disabled	Enabled	C:\MyData_103020.csv
Enabled	Disabled	C:\MyData_20031231.csv
Enabled	Enabled	C:\MyData_20031123_103020.csv

Table 3-4 shows the parameters available for each File Size Control criteria as well as their default values:

Table 3-4. File Size Control Criteria

Criteria	Parameter	Default Value	Description
None (Single File)	–	–	–
Time of Day	Time	00 Hours, 00 Minutes (Midnight)	When the time of day criteria is used, a new file will be generated every time that the time of the scan being received exceeds the time specified in the time parameter.
Duration	Duration	24 Hours and 00 Minutes	If the difference between the time in the first scan stored in the file and the time in the scan being stored exceeds the amount of time specified in this parameter, a new file will be created. Note that both hours and minutes can exceed the 23 and 59 limits respectively. (For example, you can configure 40 hours and 70 minutes)
File Size	Size	50 MB	This parameter represents the file size. If the file size is exceeded, Fluke DAQ generates a new file.
Number of Lines	Amount	65000 lines	A new file will be created every time that the number of lines (scans + additional lines in the file) being stored exceeds the Amount parameter.

Data:

Fields in this frame are used to determine the information that will be added to the Data File. The options for DIO and Totalizer will only be available in instruments where at least one module was selected.

Enable real-time data file creation:

Enables this option to generate real-time data files. The files are generated when the scan is being performed.

Note

You cannot change a data file group while the group is generating a real-time data file or an error message will display.

Real-time Data File Creation

When you start to scan a specific instrument and the instrument is master of a Data Group with the Enable real-time data file creation option selected, Fluke DAQ attempts to create a data file and start saving data to it. If another Data Group is generating a file with the same name, or if there are conflicts between the data files (they have one or more of the same instrument modules selected in common) the following error message appears.



alg146s.eps

Data Groups that conflict will not be started, but the other groups will be created and the scan will start normally. If Fluke DAQ detects a file on the disk with the same name that Fluke DAQ is trying to generate, Fluke DAQ will add data to the file or rename it depending on the File Size Control configuration.

If the Data Group has more than one instrument associated with it and you try to start only the master instrument, the following message appears:



alg147s.eps

- Click **Yes**, and Fluke DAQ will start the scan for all the instruments in the Data Group.
- Click **No**, and Fluke DAQ will start the scan and create data files for Data Groups that have a single instrument associated with them.

Note

When saving scans to the data file, Fluke DAQ verifies the criteria specified in the File Size Control and renames the file if necessary.

If the master is scanning faster than the other modules, data will be repeated for the slower modules. Computed Channels are saved using the master values; if a Computed Channel is not configured to scan with the master, the value with the closest Time Stamp between all modules is stored. The same rule is applied for DIO and Totalizer. When the Data Group has more than one instrument, the data from another instrument will be treated as additional modules, but they will have separate columns for their Computed Channels, DIO and Totalizer data values.

Main Window Advanced Settings

Use the Advanced Settings dialog to define the scan rate when an alarm occurs (Interval 3). In addition, you can disable scanning by a module or run a master independently of the group it is in.

To use the advanced settings feature

- Click  on the opening Fluke DAQ dialog.

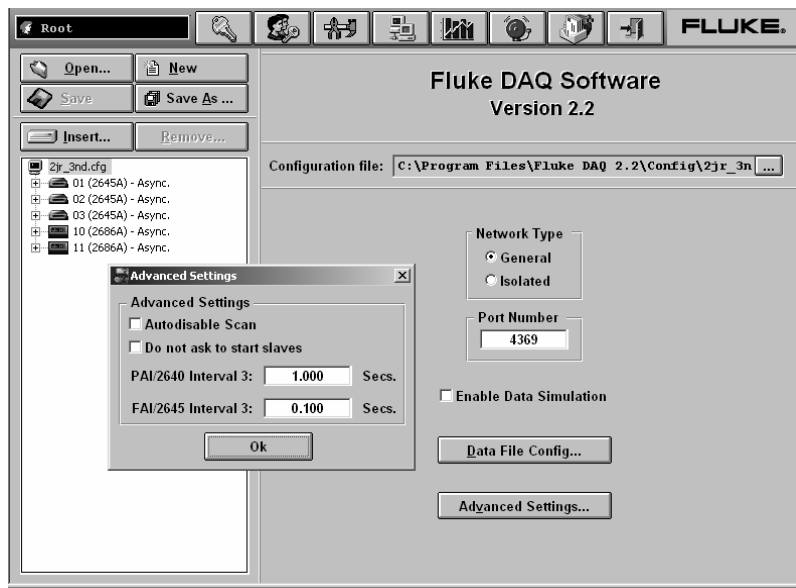

alg151.bmp

The Advanced Settings include:

Autodisable Scan

Selecting Autodisable Scan causes scanning to stop if the scan queue memory in the instrument fills up and there has been no communication from the computer for more than 30 seconds. The default is not selected, which means scanning will not stop automatically.

Do not ask to start slaves

Selecting Do not ask to start slaves prevents Fluke DAQ from asking to start other instruments grouped with a Master when the Master starts scanning. The default is not selected.

PAI/2640 Interval 3

Interval 3 is the interval the instrument checks for alarms during longer intervals between scans. PAI/2640 Interval 3 is the alarm checking interval for 2680A PAI modules and NetDAQ 2640A. You can set Interval 3 to a maximum of 1000 seconds and a minimum interval of 0.500 seconds for the PAI/2640. The default PAI/2640 Interval 3 value is 1 second.

FAI/2645 Interval 3

Interval 3 is the interval the instrument checks for alarms during longer intervals between scans. FAI/2645 Interval 3 is the alarm checking interval for 2680A FAI modules and NetDAQ 2645A. You can set Interval 3 to a maximum of 1000 seconds and a minimum interval of 0.050 seconds for the FAI/2645. The default FAI/2645 Interval 3 value is 0.100 seconds.

Using Fluke DAQ System Security Features

You can use the system security features to protect instrument configuration information. The system security feature allows the administrator to add and remove Fluke DAQ users, allow other users to configure instruments, and to change user passwords. Only the administrator (Root user) can use the security system configuration function.

Note

The Root password is blank when Fluke DAQ is installed on your PC. Use the system security features to create an administrator password and grant additional access to Fluke DAQ.

To use the system security feature

- Click the  button on the Fluke DAQ toolbar and the System Security Dialog appears.



alg131s.bmp

Add User

Click  to add a new user account name. On the Users dialog, enter the new user's name and password, then enter the password again to confirm it. Click Ok to add the new user.

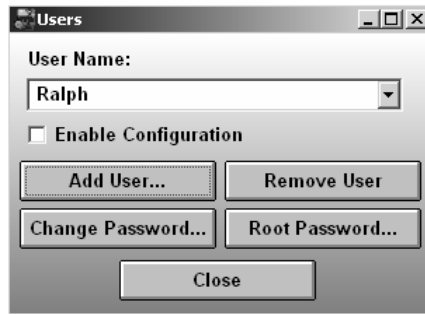

alg160s.bmp

Once you have added at least one user, the Remove User and Change Password buttons and the Enable Configuration check box are visible.

Check the Enable Configuration box to give a user permission to change the configuration of instruments using the Fluke DAQ software. Leaving the checkbox unchecked prevents the user from changing configuration settings.

Remove User

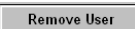
Click  to remove the user selected in the User Name list. When the dialog asking if you are sure you want to remove the user appears, click **Yes** to remove the user.

Change Password

Click  to change the password for the user selected in the User Name list. When the dialog box appears, enter the new password, then reenter it confirm the new password. Click **Ok** to change the password.

Root Password

Click  to change the password for the Root account. When the dialog box appears, enter the new password and then re-enter it to confirm the new password. Click **Ok** to change the Root password. Note that the default password for Root is blank: you should enter a password for Root when setting up multiple users in Fluke DAQ.

Configuring Web and Alarm Mail Settings

You can use the Web and Alarm Mail Settings dialog to enter Fluke DAQ web configuration information and to configure Fluke DAQ to send e-mail messages reporting alarm condition.

The Web Settings portion of dialog is used to specify a URL where scanned values from your 2680 Series or NetDAQ instrument will be sent. Use the Alarm Mail Settings portion of the dialog to configure Fluke DAQ to automatically send e-mail messages reporting alarm conditions using the Simple Mail Transfer Protocol (SMTP).

Note

To use the e-mail and web features, your PC must be connected to a network supporting the Transmission Control Protocol/Internet Protocol (TCP/IP).

To enter web and alarm mail settings

- Click the  button on the Fluke DAQ toolbar and the Web and Mail Settings dialog appears.



Web Settings

Data Server IP Address:

Uniform Resource Locator (URL):

Start Fluke DAQ Web Server on Start Up

Alarm Mail Settings Status: No errors

SMTP Server IP Address:

Originator E-Mail Address:

POP 3 Server IP Address:

User Name:

Password:

Messages' Subject:

To:

CC:

BCC:

Send alarms by e-mail

alg132s.bmp

The dialog box entries include:

Data Server IP Address

The IP address of the computer running the Fluke DAQ application. Fluke DAQ fills in this field with the first IP address found on the computer.

Note

You must change this setting if you want to use a different interface or if you are using a Dynamic Host Configuration Protocol (DHCP) on your server. If you are using a DHCP server, use the computer name instead of an IP address.

Uniform Resource Locator (URL)

The address where Fluke DAQ web files will be stored on the Internet.

Fluke DAQ fills in the field with the first IP address found on the PC. The DHCP note above also applies to this field. In addition, the Web files can be put on a separate Web server, in which case this field should be the URL for that server.

Start FlukeDAQ Web Server on Start Up

Select this check box to start the Web server automatically when the Fluke DAQ software is started.

Start FlukeDAQ Web Server

Use this button to start the Web Server manually.

Update Web Pages

Use this button to update the FlukeDAQ web pages when the Data Server address or URL has changed.

When the Web Settings are configured and the Web Server is running, two Web pages are available to view current scan data from the instruments. These Web pages are named “flukedaq268x.html”, which is for the 2680 Series, and “flukedaq264x.html”, for the NetDAQ. For example, if the URL setting above were set to <http://198.178.246.101>, entering the URL <http://129.196.136.41/flukedaq268x.html> in the address bar of a Web browser will open a page that allows you to select the instrument device and module to display current data from a 2680 Series module. You can also use a computer name in the URL entered in the browser, for example, <http://computername/flukedaq268x.html>.

Note

These Web pages use an ActiveX control to display the data. Your Web Browser must support ActiveX, such as in Internet Explorer 5.0 and later, or have a plug-in that provides the ActiveX support, to be able to open these display Web pages and view the data.

SMTP Server IP Address

SMTP server name or IP address. SMTP is the Simple Mail Transfer Protocol, a protocol for sending e-mail messages between servers.

Originator E-Mail Address

Sender e-mail address.

POP 3 Server IP Address

POP 3 name or IP Address. POP is the Post Office Protocol, used to retrieve e-mail from a mail server.

User Name

User name for authentication.

Password

The password for the user name.

Messages' Subject

Subject shown in the e-mail message.

To

Type the names of the people to whom you want to send the message.

CC

Type the names of the people to whom you want to send a copy of the message

BCC

Type the names of people who should receive the message while their names are hidden from other recipients of the message.

Send alarms by e-mail

Select the check box to enable the alarm mail settings feature.

Update

Click the Update button after changing any of the alarm mail settings.

Chapter 4

Maintenance

Contents	Page
Introduction.....	4-3
Self-Test Diagnostics and Error Codes.....	4-3
Cleaning.....	4-6
AC Fuse Replacement.....	4-7
DC Fuse Replacement.....	4-9
Performance Test.....	4-9
Configuring the Performance Test Setup.....	4-9
Initializing the Performance Test Setup.....	4-11
Accuracy Performance Tests.....	4-13
Master Alarm Output Tests.....	4-14
RS-232 Master Alarm Output Test.....	4-14
Fluke DAQ Master Alarm Output Test.....	4-14
Trigger Input Tests.....	4-15
RS-232 Trigger Input Test.....	4-15
Fluke DAQ Trigger Input Test.....	4-15
Trigger Output Tests.....	4-15
RS-232 Trigger Output Test.....	4-15
Fluke DAQ Trigger Output Test.....	4-16
Volts DC Accuracy Test (PAI Module).....	4-16
Volts DC Accuracy Test (FAI Module).....	4-17
Volts AC Accuracy Test.....	4-18
Frequency Accuracy Test.....	4-19
Analog Channel Integrity Test.....	4-20
Open Thermocouple Response Test.....	4-20
2-Wire Resistance Accuracy Test (PAI) - Optional.....	4-21
2-Wire Resistance Accuracy Test (FAI Module) - Optional.....	4-22
4-Wire Resistance Accuracy Test (PAI Module).....	4-24
4-Wire Resistance Accuracy Test (FAI Module).....	4-28
Digital Input/Output Tests.....	4-29
RS-232 Digital Input/Output Test.....	4-29
Fluke DAQ Digital Input/Output Test.....	4-30
DIO Relay/Fuse Tests.....	4-30

RS-232 DIO Relay Fuse Test	4-30
Fluke DAQ DIO Relay Fuse Test	4-30
Totalizer Tests	4-31
RS-232 Totalizer Count Test.....	4-31
RS-232 Totalizer Count and Enable Test.....	4-31
RS-232 Totalizer Count and Direction Test.....	4-32
RS-232 Totalizer Count and Debounce Test.....	4-32
Fluke DAQ Totalizer Count Test	4-33
Fluke DAQ Totalizer Count and Enable Test	4-33
Fluke DAQ Totalizer Count and Direction Test	4-34
Fluke DAQ Totalizer Count and Debounce Test	4-34
Calibration.....	4-35
Variations in the Display.....	4-35
Service.....	4-36
Replacement Parts	4-36

Introduction

Maintenance for the 2680 Series instruments is limited to self-test error code explanations, cleaning, fuse replacement, performance test, calibration, and a listing of replacement parts. The *268X Service Manual* (PN 1883791) is available for purchase.

Self-Test Diagnostics and Error Codes

Self-test diagnostics are performed each time the instrument is powered up. Any errors encountered during this initial 5 second period are reported on the front panel, as shown below.

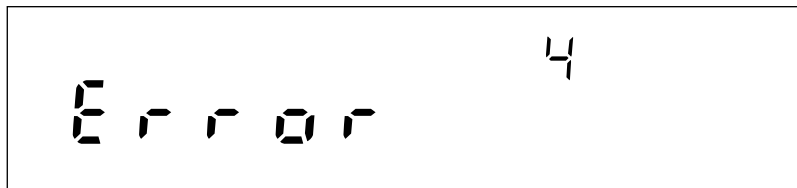

If you encounter an error code, refer to Table 4-1 for a brief description of the error. For error number 100 or greater, the current configuration does not match the configuration used for the last scan. Details of the configuration check are provided in the following paragraph. For all other errors, try cycling the instrument power. If the error persists and you intend to repair the instrument yourself, refer to the *Service Manual* (PN 1883791). Otherwise, package the instrument securely (using the original container, if available), and mail it to the nearest Fluke Service Center. Include a description of the problem. Fluke assumes no responsibility for damage in transit.

During power up, the current module configuration is evaluated against the stored module configuration used for the last scan. If configurations are different, one or more error messages will be generated. This feature helps identify faulty modules or modules that may have been accidentally removed from the system. If the configurations do not match, the stored configuration may be reset to the current configuration from the front panel. Resetting the stored configuration will eliminate the unwanted error messages.

You can also force the instrument configuration to match the installed module by pressing the MODULE button at power up. This resets the configuration to the current module mix and the previous configuration is lost. The configuration can also be changed using Fluke DAQ software by down loading a new configuration that is consistent with the module mix. You can accomplish the same thing using Fluke DAQ software to download a new configuration or by sending the *RST command using the RS-232 port.

No channels will be configured and the instrument will not scan until the proper modules are installed or the configuration is changed to match the modules loaded. Stand alone scanning using a PC card has a similar restriction.

If the PC card has a configuration in the scan data that is inconsistent with the current module mix, scanning will not begin. When using a PC card, you must either format the PC card or modify the module mix to match the PC card scan configuration before scanning can begin.

Table 4-1. Self-Test Codes

Self-Test Code	Description
0	No self-test errors
1	Boot block ROM checksum failed
2	Bad outguard main image in ROM
3	Configuration data file corrupt
4	Display test failure
5	Display not responding
6	Module 1 calibration constants corrupt
7	Module 1 calibration procedures incomplete
8	Module 1 A/D failure
9	Module 1 zero offset measurements unreasonable
10	Module 1 reference balance measurements unreasonable
11	Module 1 overload detection failed
12	Module 1 open thermocouple detection failed
13	Communication parameter constants corrupt
14	Ethernet address corrupt
15	RAM constants corrupt
16	Ethernet chip failure
17	Module 2 calibration constants corrupt
18	Module 2 calibration procedures incomplete
19	Module 2 A/D failure
20	Module 2 zero offset measurement unreasonable

Table 4-1 Self-Test Codes (continued)

Self-Test Code	Description
21	Module 2 reference balance measurements unreasonable
22	Module 2 overload detection failed
23	Module 2 open thermocouple detection failed
24	No module self-test errors
25	Module 3 calibration constants corrupt
26	Module 3 calibration procedures incomplete
27	Module 3 A/D failure
28	Module 3 zero offset measurement unreasonable
29	Module 3 reference balance measurements unreasonable
30	Module 3 overload detection failed
31	Module 3 open thermocouple detection failed
32	Module 4 calibration constants corrupt
33	Module 4 calibration procedures incomplete
34	Module 4 A/D failure
35	Module 4 zero offset measurement unreasonable
36	Module 4 reference balance measurements unreasonable
37	Module 4 overload detection failed
38	Module 4 open thermocouple detection failed
39	Module 5 calibration constants corrupt
40	Module 5 calibration procedures incomplete
41	Module 5 A/D failure
42	Module 5 zero offset measurement unreasonable
43	Module 5 reference balance measurements unreasonable
44	Module 5 overload detection failed
45	Module 5 open thermocouple detection failed
46	Module 6 calibration constants corrupt
47	Module 6 calibration procedures incomplete

Table 4-1 Self-Test Codes (continued)

Self-Test Code	Description
48	Module 6 A/D failure
49	Module 6 zero offset measurement unreasonable
50	Module 6 reference balance measurements unreasonable
51	Module 6 overload detection failed
52	Module 6 open thermocouple detection failed
100	PAI expected in slot 1
101	FAI expected in slot 1
200	PAI expected in slot 2
201	FAI expected in slot 2
300	PAI expected in slot 3
301	FAI expected in slot 3
400	PAI expected in slot 4
401	FAI expected in slot 4
500	PAI expected in slot 5
501	FAI expected in slot 5
600	PAI expected in slot 6
601	FAI expected in slot 6
602	DIO expected in slot 6

Cleaning

Warning

Keep the instrument dry to avoid electrical shock to personnel or damage to the instrument. To prevent damage, never apply solvents to the instrument housing.

Wipe the instrument with a cloth lightly dampened with water or mild detergent. Do not use aromatic hydrocarbons, chlorinated solvents, or methanol-based fluids.

AC Fuse Replacement

The instrument uses a 1/2 ampere, 250 V, slow blow line fuse in series with the mains power supply. To replace the fuse, refer to Figure 4-1 and the following procedure:

Warning

To avoid electrical shock, do not operate the instrument without the cover properly installed.

1. Disconnect *all* rear panel cables to the instrument power, Universal Input modules, and I/O connectors.
2. Locate the fuse holder at the back of the chassis near the power input connector and twist out the fuse.
3. Insert the new fuse into the holder. You *must* use a 1/2 ampere, 250 V time delay line replacement fuse.
4. Reinstall the cables removed in Step 1.

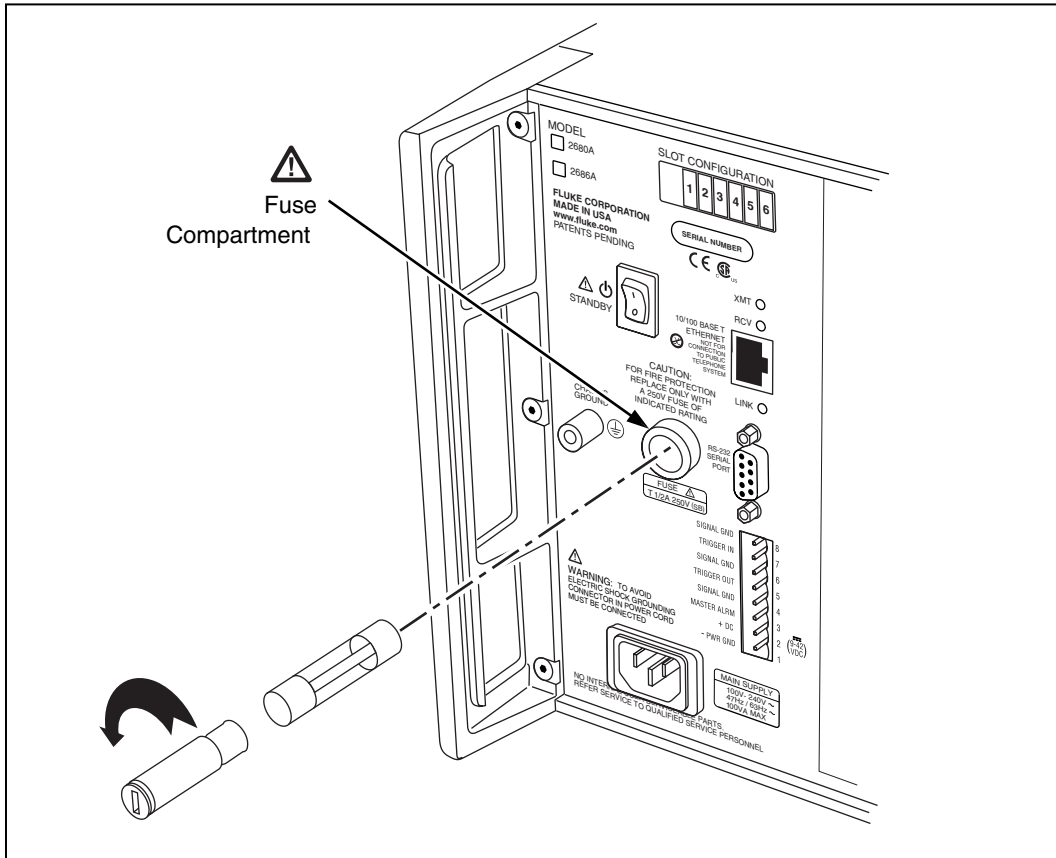

alg66f.eps

Figure 4-1. Replacing the Fuse

DC Fuse Replacement

The 2680A/2686A instruments use a 4 ampere, 125 V, slow blow fuse in series with the dc supply “+” input. This fuse is mounted on the main controller board inside the chassis. Because of potential high voltages, this fuse should only be replaced by a Fluke qualified technician. :

⚠⚠ Warning

The 2680 Series chassis contains high voltages that can be dangerous or fatal. Only qualified personnel should attempt to service the chassis.

Performance Test

When shipped, the 2680A/2686A is calibrated and in operating condition. The following performance test procedures are provided for acceptance testing upon initial receipt or to verify correct instrument operation. The performance tests must be performed in sequence.

If the instrument fails a performance test, the instrument requires service or repair. To perform these tests, you will need a Fluke 5700A Multifunction Calibrator and several other pieces of equipment meeting the minimum specifications given in Table 4-2.

Each of the measurements listed in the following steps assume the instrument is being tested after a one hour warm-up, in an environment with an ambient temperature of 18 to 28 °C, and a relative humidity of less than 70%.

Some of the digital tests can be run either through the RS-232 port or by using Fluke DAQ software. With most procedures, you can use either method to verify functionality. For the RS-232 tests, you will also need to use a program such as HyperTerminal to perform the test. See Appendix J for a complete listing of the RS-232 commands.

Configuring the Performance Test Setup

Configure the performance test setup as described below. The performance test requires a complete network connection between the host computer and 2680 Series under test, including a host computer Ethernet interface and installation of the Fluke DAQ software. If you have not yet configured and tested a network connection for the host computer and instrument, complete the appropriate installation procedure for your network configuration before conducting any performance testing.

1. **Connect the Instrument and the Host Computer** Connect the supplied Ethernet cross connect cable between the host computer Ethernet port and the 2680 Series Ethernet port.

2. **Connect the 5700A to Channel 1 of the First Module** When testing each module, connect a cable from the Output VA HI and LO connectors of the 5700A to the Universal Input module terminals for channel 1 be certain to connect the 5700A HI to terminal H and LO to terminal L. Insert the Universal Input module into the instrument under test (Figure 4-3).

Table 4-2. Recommended Test Equipment

Device Type	Minimum Specifications	Recommended Model		
Multifunction Calibrator	DC Voltage:		Fluke 5700A	
	Range: 90 mV to 300 V dc			
	Accuracy: 0.002%			
	AC Voltage:			
	Frequency	Voltage		Accuracy
	1 kHz	29 mV to 300 V		0.05%
	100 kHz	15 mV to 300 V		0.5%
	Frequency:			
	10 kHz	1 V rms		0.01%
	Ohms:			
	Ohms	Accuracy		
	190Ω	0.005%		
	1.9 kΩ	0.005%		
19 kΩ	0.005%			
190 kΩ	0.005%			
1.9 MΩ	0.005%			
Digital Multimeter	General Purpose Measurement	Fluke 77		
Signal Generator	Sine wave. 0.5 to 1 V rms, 10 Hz to 5 kHz	Philips PM5193		
Oscilloscope				
Alternative Equipment List				
Device Type		Recommended Model		
Multiproduct Calibrator		Fluke 5520		
Function/Signal Generator		Philips PM5139 or HP33120A or equivalent		
Decade Resistance Source		General Resistance RDS 66A or equivalent		

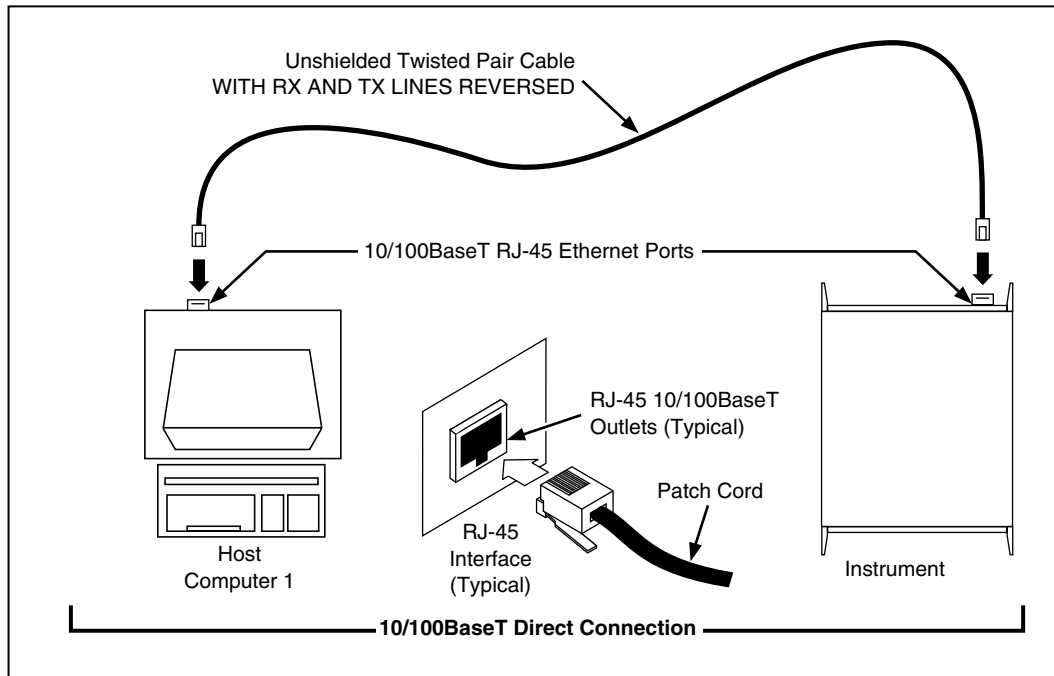

alg04f.eps

Figure 4-2. Performance Test Setup

Initializing the Performance Test Setup

Complete the following procedure to initialize the performance test setup. It is assumed you have configured the host computer and instrument as described in *Configuring the Performance Test Setup*, earlier in this Chapter. Testing begins with the instrument and host computer unpowered. This assures that at power-up self-tests are completed successfully, the correct host computer Ethernet port is activated, the host computer configuration is accurately reflected, and other background operations are completed. This procedure clears the instrument of any existing BCN, Line Frequency, and Network settings.

1. **Apply Instrument Power with Configuration Reset** Hold down the COMM key on the instrument front panel and apply power to the instrument. After the instrument beeps and momentarily displays "rESEt" (Reset), release the COMM key. If any self-test errors are reported on the front panel display, refer to Self-Test Diagnostics and Error Codes in this chapter. Configuration Reset sets the instrument to the default parameters: BCN=1, Line Frequency=60, and Isolated Network.
2. **Set the Line Frequency** If the ac power applied to your instrument is 60 Hz (default), continue to Step 3. If the ac power applied to your instrument is 50 Hz, complete this step.

Press the COMM key for three seconds, until a beep is heard and the SET annunciator in the display is lit. Press the up/down arrow keys until LinE (Line Frequency) is displayed in the primary display. Press the ENTER key. Press the up/down arrow keys until 50 (50 Hz) is displayed in the primary display. Press the ENTER key.

3. **Apply Host Computer Power** Apply power to the host computer.
4. **Open Fluke DAQ Software** You can use Start | Programs, double-click on a setup file shortcut on the Windows desktop, or double-click on a setup file name in the Windows Explorer or File Manager.
5. **Select New** Insert the instrument to be verified – 2680A or 2686A.
6. **Set network type** Set up the instrument for an isolated network.

Note

Record the IP address of the instrument before changing from a general to an isolated network type. The type change will overwrite the existing IP address.

7. **Select Module** Select the module and slot locations for each module. For each module, insert a Channel 01 and set the channel to 90 mV dc.
8. **Verify Communications** With the Communications Configuration dialog box still open, select the 2680 Series on the TreeView list and click the Verify button. The message Connection Successful! is returned for successful communications between the 2680 Series and host computer. If you receive an error message, refer to Error Codes in Appendix I. Click OK in the message box and then the Close button in the Communications Configuration File dialog box to return to the Main Window.
9. **Select Reading Rate and Trigger Out** For each module, select Reading Rate = Slow, and check the Trigger Out box.
10. **Connect ALARM/TRIGGER I/O Test Leads** Remove the 8-position ALARM/TRIGGER I/O connector from the instrument rear panel. Connect a test lead to each line, Master Alarm, Trigger Output, Trigger Input, plus a test lead to the common GND line. For more information, see Alarm/Trigger I/O Connections in Chapter 2.
11. **Connecting a DIO Module** If you have a DIO option module, connect a lead to each of the DIO lines 0 to 19. Connect leads to each relay line K1A to K8A hi lines. Connect K1A to K8A low to GRD. Connect a pair of leads to the totalizer input.

Accuracy Performance Tests

The accuracy performance tests assume you have completed the Performance Test Setup described earlier in this Chapter. Do not begin the tests until the instrument has been temperature stabilized for a minimum of one hour.

The tests for the Master Alarm output, Trigger Output, Trigger Input, and DIO signal lines can either be tested using Fluke DAQ software or using commands through the RS-232 port. For the RS-232 tests, you will also need to use a program such as HyperTerminal to perform the test. HyperTerminal is provided as a standard accessory on Windows systems.

The Accuracy Performance Tests include the following:

- Master Alarm Output Test
- Trigger Input Test
- Trigger Output Test
- Volts DC Accuracy Test
- Volts AC Accuracy Test
- Frequency Accuracy Test
- Analog Channel Integrity Test
- Open Thermocouple Response Test
- 2-Wire Resistance Accuracy Test (optional)
- 4-Wire Resistance Accuracy Test
- Digital IO/Relay
- Totalizer

Specific tests for current dc are not included since these functions are derived from V dc.

Master Alarm Output Tests

The Master Alarm signal pin is found on the rear chassis 8-pin terminal block connector. This test checks the Master Alarm output signal line for correct logic level operation. See Figure 2-3 for the Master Alarm signal pin location.

RS-232 Master Alarm Output Test

1. **Connect Test Leads to ALARM/TRIGGER I/O Connector** Remove the 8-position ALARM/TRIGGER I/O connector from the instrument rear panel. Connect a test lead to each line, Master Alarm, Trigger Output, Trigger Input, plus a test lead to the GND line.
2. **Measure Line** Using a digital multimeter, measure the output of the Master Alarm test lead, referenced to the GND test lead, to check if the voltage is greater than +3.8 V dc.
3. **Set or Clear Master Alarm Bit** To set or clear the Master Alarm bit through the RS232 port use the MAOUT 1 command to turn on the alarm output and the MAOUT 0 command to turn off the alarms output. When the alarm is on, the output should be less than 1 V.

Fluke DAQ Master Alarm Output Test

1. **Connect Test Leads to ALARM/TRIGGER I/O Connector** Remove the 8-position ALARM/TRIGGER I/O connector from the instrument rear panel. Connect a test lead to each line, Master Alarm, Trigger Output, Trigger Input, plus a test lead to the GND line.
2. **Measure Line** Using a digital multimeter, measure the output of the Master Alarm test lead, referenced to the GND test lead, to check if the voltage is greater than +3.8 V dc.
3. **Verify Configuration Channel 1 for V dc** In Fluke DAQ, verify channel 1 is configured for V dc, 3 V range.
4. **Verify Configuration Channel 1 for Alarms** In Fluke DAQ, verify channel 1 is configured for an Alarm 1 with Alarm Sense=LO, Alarm Value=1 and Digital Output=DO0.
5. **Start Instrument Scanning** Click the Start Instrument arrow in the Communication dialog to start instrument scanning. Scanning is initiated to enable the Master Alarm output. Apply 0 V to channel 1.
6. **Measure Line** Using a digital multimeter, measure the output of the Master Alarm test lead, referenced to the GND test lead, for a voltage less than +0.8 V dc.
7. **Stop Scanning** Click the Stop button to stop instrument scanning.

Trigger Input Tests

The Trigger Input signal pin is found on the rear chassis 8-pin terminal block connector. This test checks the input signal line for correct level operation.

RS-232 Trigger Input Test

1. **Read Trigger Input Bit** Use the TRIN? command to read the Trigger Input bit through the RS-232 port. A return value of zero indicates that the signal is off (high) and a value of one indicates it is active low (on).
2. **Short the Signal to GND** Use a wire to short the signal to GND to set the active state.

Fluke DAQ Trigger Input Test

1. **Configure Trigger Input** Using the Fluke DAQ software, configure the scan parameters for External Trigger with an Interval 2 of 1 second. Be sure Interval Trigger and Alarm Trigger are not enabled.
2. **Verify Configuration Channel 1 for V dc** In Fluke DAQ, verify channel 1 is configured for V dc, 3 V range.
3. **Start Instrument Scanning** Click the Start arrow in the Communication dialog to start instrument scanning, although no measurement scanning takes place because the external Trigger Input is not set.
4. **Set Trigger Input** While monitoring the Module Communication dialog, connect the Trigger Input test lead to the GND test lead. The reported values update once per second. Disconnect the Trigger Input and GND test lead connection.
5. **Stop Scanning** Click the Stop Instrument button on the Button Bar to stop instrument scanning.

Trigger Output Tests

The Trigger Output signal pin is found on the rear chassis 8-pin terminal block connector. This test checks the output signal line for correct logic operation.

RS-232 Trigger Output Test

1. **Set Trigger Output Bit** Use the TROUT command to set the Trigger Output bit through the RS-232 port. This command turns on the output for about 200 μ s.
2. **Verify Pulse** Use a scope to verify the pulse is present.

Fluke DAQ Trigger Output Test

1. **Configure Interval Trigger** Using the Fluke DAQ software, configure the scan parameters for Interval Trigger with an Interval 1 of 1 second.
2. **Verify Configuration Channel 1 for V dc** In Fluke DAQ, verify channel 1 is configured for V dc, 3 V range.
3. **Measure Unset Trigger Output Line** Using a digital multimeter, measure the output of the unset test lead, referenced to the GND test lead, for a voltage greater than +3.8 V dc.
4. **Verify Trigger Output is Enabled** In Fluke DAQ, select Setup | Instrument Config. In the Instrument Configuration dialog box, verify Trigger Out is checked. Click OK to return to the Main Window.
5. **Connect Trigger Output** Connect the Trigger Out test lead to Channel 1 of the scope.
6. **Start Instrument Scanning** Click the Start arrow in the Communication dialog to start instrument scanning.
7. **Open Spy** Open the Spy window under the Configuration dialog.
8. **Verify Trigger Out Pulse** Check that the Trigger Out pulse is $\sim 125 \mu\text{s}$ and is repeated every second.
9. **Stop Scanning** Click the Stop Instrument button on the Button Bar to stop instrument scanning.

Volts DC Accuracy Test (PAI Module)

For these tests you must move between the Fluke DAQ Configuration dialog and the Communications dialog. Use the Configuration dialog to set up the analog module channels. Use the Spy option of Communications dialog to view the measurements. All testing is done with channel 1.

The following procedure tests the accuracy of the volts dc function for each PAI module in the instrument. Measurement accuracy applies to all channels, not just the channel used for the test.

1. **Configure Channel 1 for V dc** Using the Fluke DAQ software, configure the PAI channel 1 for V dc, 90 mV range.
2. **Open Spy** Open the Spy window under the Configuration dialog. Select channel 1 for each PAI module you want to test.

3. **Verify Accuracy** Configure the 5700A for the output values below and verify the measurement is between the minimum and maximum values. Change the channel 1 range as required (see Step 1).

PAI Volts DC Range	5700A Output	Minimum Reading	Maximum Reading
90 mV	Short Circuit (Zero)	-0.000008 V	+0.000008 V
90 mV	+90 mV	+0.089980 V	+0.090020 V
90 mV	-90 mV	-0.090020 V	-0.089980 V
300 mV	Short Circuit (Zero)	-0.000017 V	+0.000017 V
300 mV	+300 mV	+0.299944 V	+0.300056 V
300 mV	-300 mV	-0.300056 V	-0.299944 V
3 V	Short Circuit (Zero)	-0.00015 V	+0.00015 V
3 V	+3 V	+2.99946 V	+3.00054 V
3 V	-3 V	-3.00054 V	-2.99946 V
30 V	Short Circuit (Zero)	-0.0017 V	+0.0017 V
30 V	+30 V	+29.9944 V	+30.0056 V
30 V	-30 V	-30.0056 V	-29.9944 V
300 V	Short Circuit (Zero)	-0.017 V	+0.017 V
300 V	+300 V	+299.944 V	+300.056 V
300 V	-300 V	-300.056 V	-299.944 V

Volts DC Accuracy Test (FAI Module)

The following procedure tests the accuracy of the volts dc function for the 268X. Measurement accuracy applies to all channels, not just the channel used for the test.

1. **Configure Channel 1 for V dc** Using the Fluke DAQ software, configure channel 1 for V dc, 90 mV range.
2. **Open Spy** Open the Spy window under the Configuration dialog.

3. **Verify Accuracy** Configure the 5700A for the output values below and verify the measurement is between the minimum and maximum values. Change the channel 1 range as required (see Step 1).

FAI Volts DC Range	5700A Output	Minimum Reading	Maximum Reading
90 mV	Short Circuit (Zero)	-0.000023 V	+0.000023 V
90 mV	+90 mV	+0.089965 V	+0.090035 V
90 mV	-90 mV	-0.090035 V	-0.089965 V
300 mV	Short Circuit (Zero)	-0.00005 V	+0.00005 V
300 mV	+300 mV	+0.29991 V	+0.30009 V
300 mV	-300 mV	-0.30009 V	-0.29991 V
3 V	Short Circuit (Zero)	-0.0004 V	+0.0004 V
3 V	+3 V	+2.9992 V	+3.0008 V
3 V	-3 V	-3.0008 V	-2.9992 V
30 V	Short Circuit (Zero)	-0.005 V	+0.005 V
30 V	+30 V	+29.991 V	+30.009 V
30 V	-30 V	-30.009 V	-29.991 V
50 V	Short Circuit (Zero)	-0.04 V	+0.04 V
50 V	+50 V	+49.95 V	+50.05 V
50 V	-50 V	-50.05 V	-49.95 V

Volts AC Accuracy Test

The following procedure tests the accuracy of the volts ac function for both the PAI and FAI modules. Measurement accuracy applies to all channels, not just the channel used for the test.

1. **Configure Channel 1 for V ac** Using the Fluke DAQ software, configure channel 1 for V ac, 300 mV range.
2. **Open Spy** Open the Spy window under the Configuration dialog.

3. **Verify Accuracy** Configure the 5700A for the output values below and verify the measurement is between the minimum and maximum values. Change the channel 1 range as required (see Step 1).

Volts AC Range	5700A Output	Minimum Reading	Maximum Reading
300 mV	20 mV@1 kHz	0.0197 V	0.0203 V
300 mV	20 mV@100 kHz	0.0185 V	0.0215 V
300 mV	300 mV@1 kHz	0.29885 V	0.30115 V
300 mV	300 mV@100 kHz	0.2845 V	0.3155 V
3 V	3 V@1 kHz	2.9885 V	3.0115 V
30 V	30 V@1 kHz	29.885 V	30.115 V
300 V	300 V@1 kHz	298.85 V	301.15 V

Frequency Accuracy Test

The following procedure tests the accuracy of the frequency function for the PAI and FAI modules. Measurement accuracy applies to all channels, not just the channel used for the test.

1. **Configure Channel 1 for Frequency** Using the Fluke DAQ software, configure channel 1 for frequency. There is no range selection for frequency as all frequency measurements use auto-ranging.
2. **Open Spy** Open the Spy window under the Configuration dialog.
3. **Verify Accuracy** Configure the 5700A for the output values below and verify the measurement is between the minimum and maximum values. Change the channel 1 range as required (see Step 1).

Frequency Range	5700A Output	Minimum Reading	Maximum Reading
Autorange Only	1 V@10 kHz	9.994 kHz	10.006 kHz

Analog Channel Integrity Test

The following procedure tests the integrity of each analog channel (2 to 20) to verify each analog channel is capable of making measurements.

1. **Configure Channel for Ohms** Using the Fluke DAQ software, configure channels 2 (then 3, then 4, etc. as this step is repeated) to 20 for Ohms 2W, 300 range [PAI] or 30 k range [FAI].
2. **Connect Test Leads** Remove the Universal Input module from the instrument, disconnect the test leads and connect them to the channel under test (starting with channel 2). Reinstall the Universal Input module in the instrument.
3. **Open Spy** Open the Spy window under the Configuration dialog.
4. **Verify Reading** Alternately open and short the test leads observing the measurement for the analog channel under test in the Spy window shows Overload for opened leads and very low resistance for shorted leads (less than $10\ \Omega$ for the PAI, or less than $1\ \text{k}\Omega$ for the FAI).
5. **Repeat Test for each Channel** Repeat steps 2 to 4 for each channel (3, 4, 5, and so forth to channel 20).

Open Thermocouple Response Test

This test checks the Open Thermocouple response.

1. **Connect an 820 Ohm Test Resistor** Remove the Universal Input module from the instrument and connect an $820\ \Omega$ resistor to the channel 1 terminals. Reinstall the Universal Input module.
2. **Configure Channel 1 for Thermocouples** In Fluke DAQ, configure channel 1 for Thermocouples with Range (thermocouple type) K.
3. **Open Spy** Open the Spy window under the Configuration dialog.
4. **Connect a 10 k Ohm Test Resistor** Remove the Universal Input module from the instrument and connect a $10\ \text{k}\Omega$ resistor to the channel 1 terminals to simulate an open thermocouple condition. Reinstall the Universal Input module.
5. **Verify Open Thermocouple** The Spy window indicates an open thermocouple detect condition by displaying Open TC in place of a temperature reading.

2-Wire Resistance Accuracy Test (PAI) - Optional

Complete the following procedure to test the accuracy of the resistance function for the PAI using 2 terminals. Measurement accuracy applies to all channels, not just the channel used for the test. The 4-wire resistance accuracy test is more rigorous and you may wish to skip this step and continue to 4-Wire Resistance Accuracy Test described later in this Chapter.

1. **Connect the Resistance Source to Channel 1** Remove the Universal Input module from the instrument and connect a cable from the Decade Resistance Source to the Universal Input module terminals for channel 1. Reinstall the Universal Input module. You may also use the 5700A resistance calibration output instead of the Decade Resistance Source. Tables are provided for both connections.
2. **Configure Channel 1 for Ohms** In Fluke DAQ, configure channel 1 for Ohms-2W, 300 range.
3. **Open Spy** Open the Spy window under the Configuration dialog.
4. **Verify Accuracy** Configure the Decade Resistance Source for the output values below and verify the Spy window measurement is between the minimum and maximum values. Change the channel 1 range as required (see Step 2).

Resistance Range*	Decade Resistor	Minimum Reading	Maximum Reading
300 Ω	Short Circuit (Zero)	0 Ω	10 Ω
300 Ω	290 Ω	289.86 Ω	300.14 Ω
3 kΩ	Short Circuit (Zero)	0 Ω	10.5 Ω
3 kΩ	2.9 kΩ	2.8986 kΩ	2.9114 kΩ
30 kΩ	29 kΩ	28.983 kΩ	29.027 kΩ
300 kΩ	290 kΩ	289.61 kΩ	290.39 kΩ
3 MΩ	2.9 MΩ	2.8914 MΩ	2.9086 MΩ

* The resistance accuracy in this table makes allowance for up to 0.1 Ω of lead wire resistance plus 0.01% decade resistance tolerance. You must add any additional lead wire resistance present in your setup to the resistance values given in this table.

Resistance Range*	5700A	Minimum Reading	Maximum Reading
300 Ω	Short Circuit (Zero)	0 Ω	10 Ω
300 Ω	190 Ω	189.91 Ω	200.09 Ω
3 k Ω	Short Circuit (Zero)	0 Ω	10.5 Ω
3 k Ω	1.9 k Ω	1.8991 k Ω	1.9109 k Ω
30 k Ω	19 k Ω	18.989 k Ω	19.021 Ω
300 k Ω	190 k Ω	189.75 k Ω	190.26 k Ω
3 M Ω	1.9 M Ω	1.8942 M Ω	1.9058 M Ω

* The resistance accuracy in this table makes allowance for up to 0.1 Ω of lead wire resistance. You must add any additional lead wire resistance present in your setup to the resistance values given in this table. Using the 5700A in 2-wire compensation mode eliminates much of the lead resistance errors. See the 5700A Operator's Manual for details.

2-Wire Resistance Accuracy Test (FAI Module) - Optional

Complete the following procedure to test the accuracy of the resistance function for the FAI module using 2 terminals. Measurement accuracy applies to all channels, not just the channel used for the test. The 4-wire resistance accuracy test is more rigorous and you may wish to skip this step and continue to 4-Wire Resistance Accuracy Test described later in this Chapter.

1. **Connect the Resistance Source to Channel 1** Remove the Universal Input module from the instrument and connect a cable from the Decade Resistance Source to the Universal Input module terminals for channel 1. Reinstall the Universal Input module. You may also use the 5700A resistance calibration output instead of the Decade Resistance Source. Tables are provided for both connections.
2. **Configure Channel 1 for Ohms** In Fluke DAQ, configure channel 1 for Ohms 2W, 30 k range.
3. **Open Spy** Open the Spy window under the Configuration dialog.
4. **Verify Accuracy** Configure the Decade Resistance Source for the output values below and verify the Spy window measurement is between the minimum and maximum values. Change the channel 1 range as required (see Step 2).

Resistance Range*	Decade Resistor	Minimum Reading	Maximum Reading
30 k Ω	Short Circuit (Zero)	700 Ω	1 k Ω
30 k Ω	29 k Ω	29.681 k Ω	30.019 k Ω
300 k Ω	290 k Ω	289.07 k Ω	292.63 k Ω
3 M Ω	2.9 M Ω	2.8607 M Ω	2.9410 M Ω
* The resistance accuracy in this table makes allowance for up to 0.1 Ohm of lead wire resistance plus 0.01% decade resistance tolerance. You must add any additional lead wire resistance present in your setup to the resistance values given in this table.			

Resistance Range*	5700A	Minimum Reading	Maximum Reading
30 k Ω	Short Circuit (Zero)	700 Ω	1 k Ω
30 k Ω	19 k Ω	19.686 k Ω	20.014 k Ω
300 k Ω	190 k Ω	189.60 k Ω	192.10 k Ω
3 M Ω	1.9 M Ω	1.8740 M Ω	1.9277 M Ω
* The resistance accuracy in this table makes allowance for up to 0.1 Ω of lead wire resistance. You must add any additional lead wire resistance present in your setup to the resistance values given in this table. Using the 5700A in 2-wire compensation mode eliminates much of the lead resistance errors. See the 5700A Operator's Manual for details			

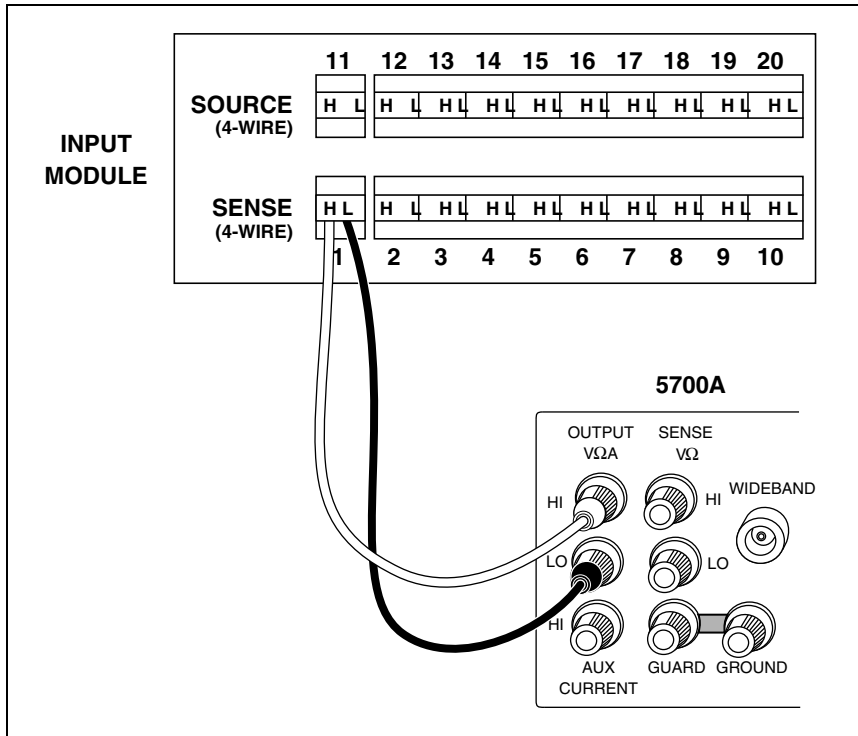

alg68f.eps

Figure 4-3. 2-Wire Connections to 5700A

4-Wire Resistance Accuracy Test (PAI Module)

1. **Connect the Resistance Source to Channels 1 and 11** Remove the Universal Input module from the instrument and connect a cable from the Decade Resistance Source to the Universal Input module terminals for channel 1 (Sense) and channel 11 (Source) as shown in Figure 4-4. Reinstall the Universal Input module. You may also use the 5700A resistance calibration output instead of the Decade Resistance Source. Tables are provided for both connections. Refer to Figure 4-5 for the 5700A 4-wire connections.
2. **Configure Channel 1 for Resistance** In Fluke DAQ, configure channel 1 for Ohms 4W, 300 range.
3. **Open Spy** Open the Spy window under the Configuration dialog.

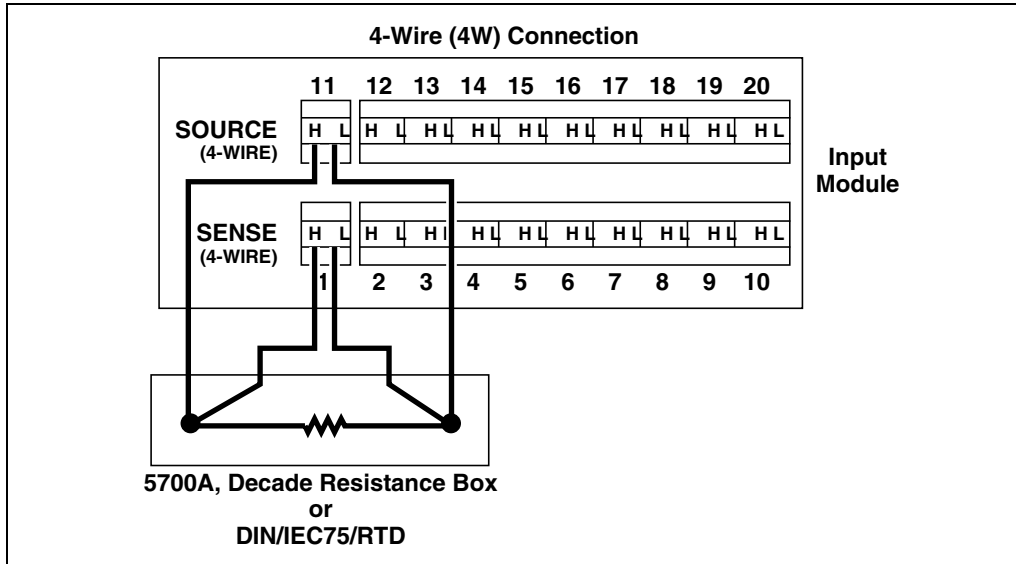

alg69f.eps

Figure 4-4. 4-Wire Connections to the Universal Input Module (Resistor)

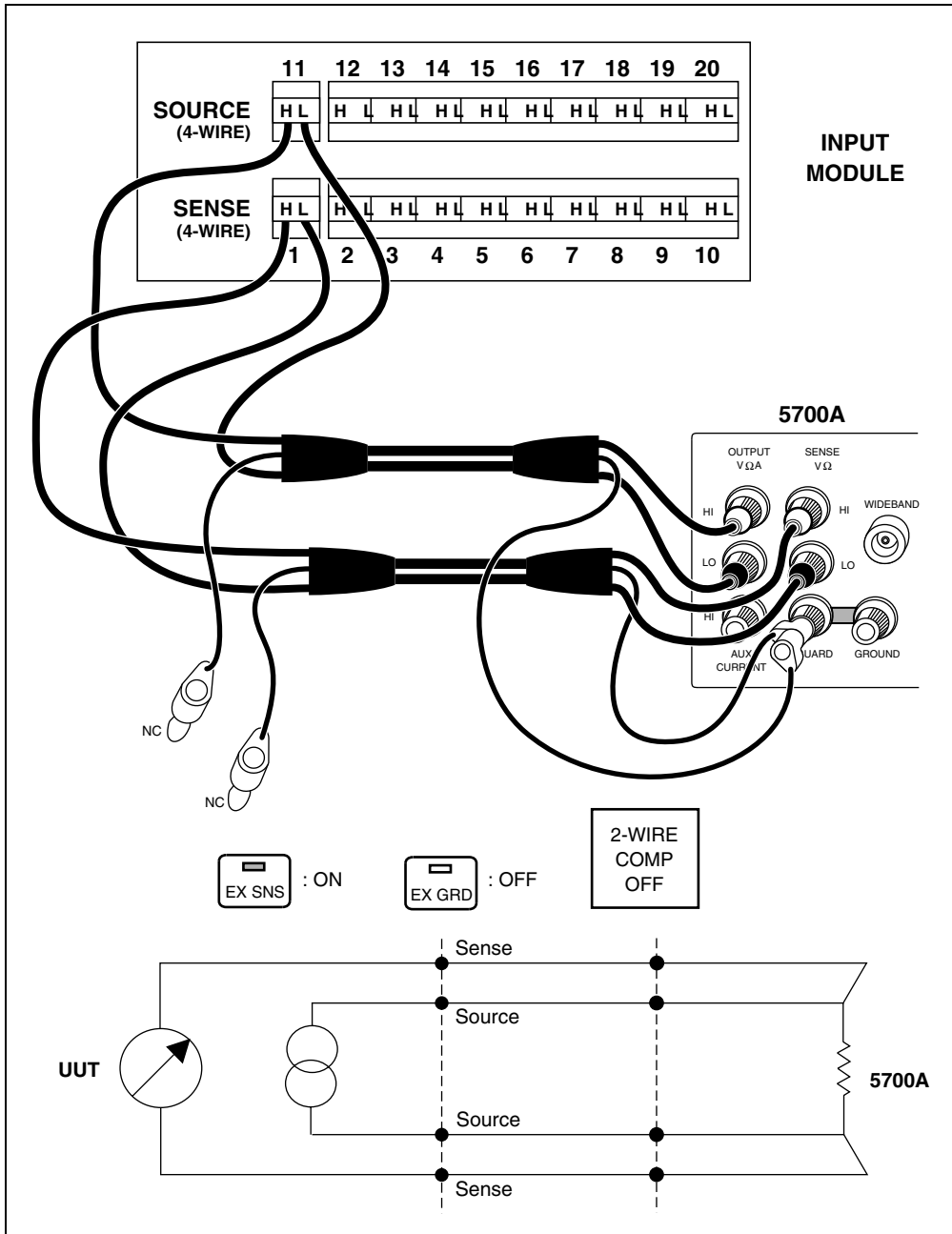

Figure 4-5. 4-Wire Connections to the Universal Input Module (5700A)

alg70f.eps

4. **Verify Accuracy** Configure the Decade Resistance Source for the output values below and verify the Spy window measurement is between the minimum and maximum values. Change the channel 1 range as required (see Step 2).

Resistance Range	Decade Resistor	Minimum Reading	Maximum Reading
300 Ω	Short Circuit (Zero)	0 Ω	0.05 Ω
300 Ω	290 Ω	289.861 Ω	290.139 Ω
3 kΩ	Short Circuit (Zero)	0 Ω	0.5 Ω
3 kΩ	2.9 kΩ	2.89849 kΩ	2.90137 kΩ
30 kΩ	29 kΩ	28.9834 kΩ	29.0166 kΩ
300 kΩ	290 kΩ	289.621 kΩ	290.379 kΩ
3 MΩ	2.9 MΩ	2.89146 MΩ	2.90854 MΩ
The resistance accuracy in this table makes allowance for up to 0.01% decade resistance tolerance.			

Resistance Range	5700A	Minimum Reading	Maximum Reading
300 Ω	Short Circuit (Zero)	0 Ω	0.030 Ω
300 Ω	190 Ω	189.912 Ω	190.088 Ω
3 kΩ	Short Circuit (Zero)	0 Ω	0.30 Ω
3 kΩ	1.9 kΩ	1.89912 kΩ	1.90088 kΩ
30 kΩ	19 kΩ	18.9893 kΩ	19.0107 kΩ
300 kΩ	190 kΩ	189.750 kΩ	190.250 kΩ
3 MΩ	1.9 MΩ	1.89425 MΩ	1.90575 MΩ

4-Wire Resistance Accuracy Test (FAI Module)

1. **Connect the Resistance Source to Channels 1 and 11** Remove the Universal Input module from the instrument and connect a cable from the Decade Resistance Source to the Universal Input module terminals for channel 1 (Sense) and channel 11 (Source) as shown in Figure 4-4. Reinstall the Universal Input module. You may also use the 5700A resistance calibration output instead of the Decade Resistance Source. Tables are provided for both connections. Refer to Figure 4-5 for the 5700A 4-wire connections.
2. **Configure Channel 1 for Resistance** In Fluke DAQ, configure channel 1 for Ohms 4W, 300 range.
3. **Open Spy** Open the Spy window under the Configuration dialog.
4. **Verify Accuracy** Configure the Decade Resistance Source for the output values below and verify the Spy window measurement is between the minimum and maximum values. Change the channel 1 range as required (see Step 2).

Resistance Range	Decade Resistor	Minimum Reading	Maximum Reading
300 Ω	Short Circuit (Zero)	0 Ω	0.1 Ω
300 Ω	290 Ω	289.81 Ω	290.19 Ω
3 k Ω	Short Circuit (Zero)	0 Ω	1.0 Ω
3 k Ω	2.9 k Ω	2.8981 k Ω	2.9019 k Ω
30 k Ω	29 k Ω	28.981 k Ω	29.019 k Ω
300 k Ω	290 k Ω	288.37 k Ω	291.63 k Ω
3 M Ω	2.9 M Ω	2.8600 M Ω	2.9400 M Ω
The resistance accuracy in this table makes allowance for up to 0.01% decade resistance tolerance.			

Resistance Range	5700A	Minimum Reading	Maximum Reading
300 Ω	Short Circuit (Zero)	0 Ω	0.1 Ω
300 Ω	190 Ω	189.86 Ω	190.14 Ω
3 kΩ	Short Circuit (Zero)	0 Ω	1.0 Ω
3 kΩ	1.9 kΩ	1.8986 kΩ	1.9014 kΩ
30 kΩ	19 kΩ	18.986 kΩ	19.014 kΩ
300 kΩ	190 kΩ	188.90 kΩ	191.10 kΩ
3 MΩ	1.9 MΩ	1.8733 MΩ	1.9267 MΩ

Digital Input/Output Tests

All configuration for the Digital Input/Output Tests is done using the Communications dialog. To change DIO settings, click the DIO module icon in the TreeView display. Use the Spy function to monitor DIO settings.

The Digital Input/Output Tests check the 20 Digital I/O lines on the Digital I/O connector for output and input functions

RS-232 Digital Input/Output Test

To output bits use the DIO <mask>,<value> command. Set the mask to 1048575. Use the command "DIO?" for input. The value can range from 1 to 1048575 ($2^{20} - 1$).

1. **Set Signal Lines High** Set all of the signal lines high using the DIO 1048575,1048575 command.
2. **Verify Signal** Verify that all of the signal lines are equal to or greater than +3.5 V dc.
3. **Set Signal Line Low** Set all of the signal lines low using the DIO 1048575,0 command.
4. **Verify Signal** Verify that all of the signal lines are less than or equal to 1 V dc. Leave them all low.
5. **Toggle Each Line** Toggle each line and verify that the signal line responds. For example, to toggle DIO0 output, send the command DIO 1048575,1. Physically verify that the signal line is off (high) and then use the DIO? command to read back the setting. Clear the bit using DIO 1048575,0. Physically verify that the signal line is on (low) and then use the DIO? command to read back the setting. To toggle DIO 7, send the command DIO 1048575,128 followed by DIO 1048575,0. To toggle DIO 19, send the

command DIO 1048575,524288 followed by DIO 1048575,0. Verify that the correct lines are active.

Fluke DAQ Digital Input/Output Test

1. **Open Communication Dialog** Use the Communication dialog in Fluke DAQ for this test. Click on the DIO module icon in the TreeView display to see the DIO settings. The DIO dialog will only work if the DIO module is installed in the instrument and has been inserted using the Configuration dialog.
2. **Set Signal Lines Low** Set all of the signal lines active low by clicking on the Set On for each channel. On the screen, there should be an indication that the signal is active.
3. **Verify Signal** Verify that all of the signal lines are less than or equal to 1 V dc.
4. **Set Signal Lines High** Set all of the signal lines high by deselecting them.
5. **Verify Signal** Verify that all of the signal lines are equal to or greater than +3.5 V dc.
6. **Toggle Each Line** Toggle each line and verify that the signal line responds. Verify that the correct lines are active.

DIO Relay/Fuse Tests

RS-232 DIO Relay Fuse Test

Use the RS-232 command RELAY <mask>,<value> command to verify operation of the relays. The mask should always be set to 255. The value can be set from 1 to 255 depending on the bit to be set. For example, to set the relay pair K1A/K1B, send RELAY 1,0. To clear the relay pair, send RELAY 1,1. To set relay pair K8A/K8B, send RELAY 128,0 and to clear the pair send RELAY 128,128.

1. **Connect Test Leads to Digital IO Relays** Remove the DIO Connector module from the DIO rear panel. Connect test leads to the 4 terminals of each relay, KA hi, KA lo, KB hi, and KB lo.
2. **Verify Resistance** In the Communication dialog for the DIO module, select each relay in turn. Using a volt meter, verify that each relay channel has less than 2 Ω of resistance from high to low. A higher resistance value indicates that a fuse needs to be replaced.

Fluke DAQ DIO Relay Fuse Test

1. **Open Communication Dialog** Use the Communication dialog in Fluke DAQ for this test. Click on the DIO module icon in the TreeView display to see the DIO settings. The DIO dialog will only work if the DIO module is installed in

the instrument and has been inserted using the Configuration dialog. Use the relay settings capability shown in the dialog to control the relays.

2. **Set Each Relay Pair** Set each relay pair. R#1 corresponds to the DIO relays K1A/K1B.
3. **Verify Relays Close** Verify that relays close by measuring the contact resistance. A contact resistance less than 1 Ω is good.

Totalizer Tests

The totalizer tests check the correct operation of the totalizer including the direction of counting and the signal level sensitivity. These tests can be run either with RS-232 commands or using Fluke DAQ. For these tests, use the signal generator to generate the counts. The generator will be connected to the totalizer input signal line (Σ). Connect the DIO channel 0 signal line to the totalizer enable line (Σ en) in the connector module.

If you are using Fluke DAQ to perform the totalizer tests, select the DIO from TreeView in the Configuration dialog. In the DIO Configuration dialog, Set the start count in the DIO Configuration dialog to 0, deselect debounce (if selected), and select direction as up. Click the Communication icon and select the DIO from the TreeView. Deselect the DIO channel 0 (if selected) to enable the totalizer

RS-232 Totalizer Count Test

1. **Initialize Totalizer to Count Up** Initialize the totalizer to count up with the command TOTCFG <direction>,<debounce>, where direction is 1 for up and debounce is 0 for off.
2. **Initialize Totalizer to 0** Initialize the totalizer to 0 with the TOTINIT command.
3. **Read the Totalizer Value** Read the totalizer value with the TOT? command. The value should be zero.
4. **Set DIO** Set DIO 0 to 0 (off) which will enable the totalizer to count.
5. **Set the Generator** Set the generator to 10 Hz and 1 V pp and connect to the totalizer input
6. **Verify Totalizer Count** Verify that the totalizer count increases by about 10 counts per second in a positive direction.
7. **Disconnect Generator** Disconnect the signal generator.

RS-232 Totalizer Count and Enable Test

The enable signal is a hardware signal that must be disabled with an externally connected signal level such as a short to ground)

1. **Initialize Totalizer to 0** Initialize the totalizer to 0 with the TOTINIT command.
2. **Set DIO** Set DIO 0 to 1 (on) to disable the totalizer.
3. **Reconnect Signal Generator** Reconnect the signal generator.
4. **Verify Totalizer Count** Verify that the totalizer count stays at 0.
5. **Disconnect Signal Generator** Disconnect the signal generator.

RS-232 Totalizer Count and Direction Test

1. **Initialize Totalizer to 0** Initialize the totalizer to 0 with the TOTINIT command.
2. **Set Totalizer to Down Count** Set the totalizer to down count with the TOTCFG 0,0 command.
3. **Set DIO** Set DIO 0 to 0 to enable the totalizer.
4. **Reconnect Signal Generator** Reconnect the signal generator.
5. **Verify Totalizer Count** Verify that the totalizer counts from 0 to 4,294,967,295, and then down.
6. **Disconnect Signal Generator** Disconnect the signal generator.

RS-232 Totalizer Count and Debounce Test

1. **Initialize Totalizer to 0** Initialize the totalizer to 0 with the TOTINIT command.
2. **Set Totalizer to Up Count** Set the totalizer to up count with debounce on with the TOTCFG 1,1 command.
3. **Set DIO** Set DIO 0 to 0 to enable the totalizer.
4. **Set Signal Generator** Set the signal generator to 1 kHz at 1 V pp.
5. **Connect Signal Generator** Connect the signal generator.
6. **Verify Totalizer Count** Verify that the totalizer stays at 0+/-1 count.
7. **Disconnect Signal Generator** Disconnect the signal generator.

Testing of the Digital Input/Output signal lines can be done through the RS-232 port (using HyperTerminal or other communication program) or through the Fluke DAQ software. Either method can be used. The Digital Input/Output Test checks the 20 Digital I/O lines through the Digital I/O connector module for correct operation. Measurements of the signal lines may be made using an oscilloscope or a voltmeter. See Figure 2-7 for the layout of the DIO module connector.

Fluke DAQ Totalizer Count Test

1. **Go to Spy Window** Go to the Spy Window.
2. **Set Instrument Number** Set the instrument number to the BCN number of the instrument and set the category as totalizer.
3. **Start Spy** Start the Spy with the play button.
4. **Verify Totalizer Value** Verify that the totalizer value is set to zero.
5. **Set Signal Generator** Set the signal generator to 10 Hz and 1 V pp and connect to the totalizer input.
6. **Verify Totalizer Count** Verify that the totalizer count increases by about 10 counts per second in a positive direction.
7. **Stop Spy** Stop the Spy.
8. **Disconnect Signal Generator** Disconnect the signal generator.

Fluke DAQ Totalizer Count and Enable Test

1. **Select DIO** Click on the Communication icon and select the DIO from the TreeView.
2. **Disable Totalizer** Select the DIO channel 0 to disable the totalizer.
3. **Start Spy** Go to the Spy and start the Spy with the play button.
4. **Verify Totalizer Value** Verify that the totalizer value has not changed.
5. **Set Signal Generator** Set the signal generator to 10 Hz and 1 V pp and connect to the totalizer input.
6. **Verify Totalizer Count** Verify that the totalizer count does not change.
7. **Stop Spy** Stop the Spy.
8. **Disconnect Signal Generator** Disconnect the signal generator.
9. **Select DIO** Click on the Communication icon and select the DIO from TreeView.
10. **Enable Totalizer** Deselect the DIO channel 0 to enable the totalizer.

Fluke DAQ Totalizer Count and Direction Test

1. **Configure DIO** In the Configuration dialog, select the DIO from TreeView. In the DIO Configuration dialog, set the start count to 0, deselect debounce (if selected), and select direction as down.
2. **Start Spy** Go to the Spy and start the Spy with the play button.
3. **Verify Totalizer Value** Verify that the totalizer value is has not changed.
4. **Set Signal Generator** Set the signal generator to 10 Hz and 1 V pp and connect to the totalizer input.
5. **Verify Totalizer Count** Verify that the totalizer count decreases by about 10 counts per second.
6. **Stop Spy** Stop the Spy.
7. **Disconnect Signal Generator** Disconnect the signal generator.

Fluke DAQ Totalizer Count and Debounce Test

1. **Configure DIO** In the Configuration dialog, select the DIO from TreeView. In the DIO Configuration dialog, set the start count to 0, select debounce on, and select direction as up.
2. **Start Spy** Go to the Spy and start the Spy with the play button.
3. **Verify Totalizer Value** Verify that the totalizer value has not changed.
4. **Set Signal Generator** Set the signal generator to 1 kHz and 1 V pp and connect to the totalizer input.
5. **Verify Totalizer Count** Verify that the totalizer count does not change by more than 1 count.
6. **Stop Spy** Stop the Spy.
7. **Disconnect Signal Generator** Disconnect the signal generator.

Calibration

Note

Refer to the Service Manual (PN 1883791) for calibration procedures. The instrument must be stabilized in an environment with an ambient temperature of 22 °C to 24 °C and a relative humidity of less than 70%, and must have been powered at least 30 minutes prior to calibration.

The instrument features closed-case calibration, that is, calibration that is completed over the RS-232 interface. Using known reference sources, closed-case calibration has many advantages. There are no parts to disassemble, no mechanical adjustments to make, and the instrument can be calibrated by an automated instrumentation system.



The instrument should normally be calibrated on a regular cycle, typically every 90 days to 1 year. The chosen calibration cycle depends on the accuracy specification you wish to maintain. The instrument should also be calibrated if it fails the performance test or has undergone repair.

Variations in the Display

Under normal operation, the display presents various combinations of brightly and dimly lit annunciators and digits. However, you may encounter other, random irregularities across different areas of the display under the following circumstances:

- After prolonged periods of displaying the same information
- The display has not been used for a prolonged period

This phenomenon can be cleared by activating the entire display and leaving it on overnight (or at least for several hours). Use the following procedure to keep the display fully lit:

1. Turn the instrument power off.
2. Press the front panel  key and then apply power. Continue to hold the  key until the instrument beeps. The entire front panel display comes on and stays on.
3. When you wish to return the display to normal, press any front panel key.

Service

If the instrument fails to operate, check that operating instructions presented earlier in this manual are being followed. If the problem cannot be remedied, send the instrument, postage paid, to the nearest Fluke Service Center. Be sure to pack the instrument securely; use the original container if available. Include a description of the problem. Fluke assumes no responsibility for damage in transit.

To contact Fluke, call one of the following telephone numbers:

USA: 1-888-99-FLUKE (1-888-993-5853)
 Canada: 1-800-36-FLUKE (1-800-363-5853)
 Europe: +31 402-675-200
 Japan: +81-3-3434-0181
 Singapore: +65-738-5655
 Anywhere in the world: +1-425-446-5500

Or, visit Fluke's Web site at <http://www.fluke.com>.

Replacement Parts

Replacement parts are listed below. To order replacement parts in the USA, call 1-800-526-4731. To order parts from outside the USA, contact the nearest Fluke Service Center. Other device models, options and accessories are listed in Table 1-1.

Table 4-3. Replacement Parts

Part Number	Description
284174	Power Cable (U. S.)
851712	RS-232 Cable (for calibration) 9-pin socket to 25-pin socket
1631800	Terminal Block
1883791	Service Manual
109322	AC Replacement Fuse
1883699	DC Replacement Fuse
460972	DIO Replacement Fuse
1777885	Ethernet Cross Cable CAT V (3-meter)

Appendices

	Contents	Page
A	Specifications.....	A-1
B	Noise, Shielding, and Crosstalk Considerations	B-1
C	True-RMS Measurements.....	C-1
D	RTD Linearization	D-1
E	Computed Channel Equations	E-1
F	Data File Format	F-1
G	Ethernet Cabling	G-1
H	Network Considerations	H-1
I	Error Codes.....	I-1

Appendix A Specifications

Introduction

Specifications are divided into four sections. The first section contains the specifications that apply to both the 2680A and 2686A instruments. The second section contains specifications that apply only to the Precision Analog Input (PAI) module. The third section contains specifications that apply only to the Fast Analog Input (FAI) module. The last section contains information only for the Digital I/O, Relay, and the Totalizer (DIO) module.

2680A/2686A Combined Specifications

The following specifications apply to both the 2680A and 2686A instruments. The topics include:

- General Specifications
- PAI/FAI Environmental Specifications
- DIO Digital I/O and Totalizer Interface

2680A/2686A General Specifications

Table A-1 provides the general specifications for the 2680 Series instruments.

Table A-1. 2680 Series General Specifications

Specification	Characteristic								
Input Channel Capacity	Maximum of 120 channels (Precision or Fast Analog Input) per chassis								
Optional DIO	20 digital input and output channels, 8 double pole-single throw relay channels, a totalizer input, and a totalizer enable input.								
Computed Channels	60								
Size	473 mm (18.6 in) x 432 mm (17 in) x 237 mm (9.3 in)								
Weight	<table> <tr> <td>2680A/2686A (empty)</td> <td>8.6 Kg (18.9 lb)</td> </tr> <tr> <td>2680A – FAI</td> <td>0.8 Kg (1.8 lb)</td> </tr> <tr> <td>2680A – PAI</td> <td>1.2 Kg (2.7 lb)</td> </tr> <tr> <td>2680A – DIO</td> <td>0.8 Kg (1.8 lb)</td> </tr> </table>	2680A/2686A (empty)	8.6 Kg (18.9 lb)	2680A – FAI	0.8 Kg (1.8 lb)	2680A – PAI	1.2 Kg (2.7 lb)	2680A – DIO	0.8 Kg (1.8 lb)
2680A/2686A (empty)	8.6 Kg (18.9 lb)								
2680A – FAI	0.8 Kg (1.8 lb)								
2680A – PAI	1.2 Kg (2.7 lb)								
2680A – DIO	0.8 Kg (1.8 lb)								
Power	100 – 240 V ac (no switching required), 50 to 60 Hz, 100 VA maximum or optional 9 V dc to 45 V dc, 35 W maximum								
EMC	EN50082-2 EN55022-1 EN55011 class A EN610000-4-2,3,4,6,8 EN61326								
Safety	EN61010-1, CAT II (DIO is rated CAT I) CSA C22.2 No. 1010.1								
Serial Interface	Connector: 9 pin male (DB9) Signals: Tx, Rx, DTR, RTS, GND Modem Control: full duplex Baud rates: 4800, 9600, 19200, 38400 (19,200 default) Data format: 8 data bits, no parity, one stop bit Flow Control: XON/XOFF Echo: off								
Common Mode Voltage	Precision Analog Input: 150 (300 on channels 1 and 11) V dc or ac RMS Fast Analog Input: 50 V dc or 30 V ac rms								
Operating Temperature Range	-20 °C to 60 °C (-4 °F to +140 °F)								
Storage Temperature Range	-40 °C to 70 °C (-40 °F to +158 °F)								

Table A-1. 2680 Series General Specifications (cont)

Specification	Characteristic
Relative Humidity	90% maximum for -10 °C to 28 °C (14 °F to +82 °F) 75% maximum for 28 °C to 35 °C (82 °F to +95 °F) 50% maximum for 35 °C to 60 °C (95 °F to +140 °F) (3 MΩ range, reduce humidity rating by 25% for 1 hour warm-up. 3 MΩ range meets full humidity ratings with 2 hour warm-up)
Altitude	Operating: 2,000 m (6,562 ft) maximum Non-operating: 12,200 m (40,000 ft) maximum
Warm-up Time	1 hour to rated specifications -or- 15 minutes if relative humidity (non-condensing) is 50% or less.

Real-Time Clock and Calendar

The next table provides a summary of the battery powered real-time clock and calendar.

Table A-2. 2680A/2686A Real-Time Clock and Calendar

Specification	Characteristic
Accuracy	1 minute per month for 0 °C to 50 °C range
Battery Life	>5 unpowered instrument years for 20 °C to 28 °C (68 °F to 82.4 °F).

Trigger In Specifications

The following table provides a summary of the Trigger In specifications. The Trigger In input is located on the rear panel connector, terminals Trigger In and Signal GND.

Table A-3. Trigger In Specification

Specification	Characteristic
Logical High - Trigger not set	Minimum: 2.0 V Maximum: 7.0 V
Logical Low - Trigger set	Minimum: -0.6 V Maximum: +0.8 V
Compatibility	TTL or Contact Closure
Isolation	None (dc coupled)
Minimum Pulse Width	5 μ s
Maximum Frequency	Nominal 400 Hz
Repeatability	3 ms

Trigger Out Specifications

The next table provides a summary of the Trigger Out specifications. The Trigger Out output is located on the rear panel connector, terminals Trigger Out and Signal GND.

Table A-4. Trigger Out Specification

Specification	Characteristic
TTL Logical Zero - Trigger Out Set	0.8 V maximum for an lout of -1.0 mA (1 LSTTL load)
TTL Logical One - Trigger Out Not Set	3.8 V minimum for an lout of 0.05 mA (1 LSTTL load)
Non-TTL Load Zero - Trigger Out Set	1.8 V maximum for an lout of -20 mA 3.25 V maximum for an lout of -50 mA
Pulse Duration (Logic Low)	125 μ s
Isolation	None

Master Alarm Output Specification

The following specifications cover the Master Alarm output. The Master Alarm output is located on the rear panel connector, terminals Master Alarm, and Signal GND.

Table A-5. Master Alarm Output Specification

Specification	Characteristic
Output Voltage - TTL Logical Zero	0.8 V maximum for an lout of -1.0 mA (1 LSTTL load)
Output Voltage - TTL Logical One	3.8 V minimum for an lout of 0.05 mA (1 LSTTL load)
Output Voltage - Non-TTL Load Zero	1.8 V maximum for an lout of -20 mA 3.25 V maximum an lout of -50 mA

Communication I/O

Communication with 2680 Series instruments can be accomplished through either a 10/100BaseT interface or through an RS-232 port. The 10/100BaseT provides the primary communication interface. The RS-232 is used for calibration and limited debug capability.

2686A PC Card Storage

The 2686A supports a non-volatile PC Card (PCMCIA ATA type card) memory module option. This table provides a list of active channels and the number of scans to memory card capacity.

Table A-6. 2686A - Active Channels and Number of Scans to Card Capacity

Memory Card/ Active Channels	20 ch	40 ch	60 ch	80 ch	100 ch	120 ch
16 MB	100,548	66,765	50,074	40,059	33,382	28,613
128 MB	800,000	528,000	400,000	320,000	264,000	224,000
256 MB	1.6 M	1.056 M	800,000	640,000	528,000	448,000
512 MB	3.2 M	2.112 M	1.6 M	1.28 M	1.056 M	896,000
1 GB	6.2 M	4.224 M	3.2 M	2.56 M	2.112 M	1.792 M
Estimating space: 80 bytes/scan + 4 bytes/channel scanned (allow 4.5% overhead for card formatting)						

Precision Analog Input (PAI) Module Specifications

This section includes specifications specific to the PAI Module instrument by measurement function.

Specifications PAI Module DC Voltage Measurement

The following tables provide PAI Module specifications for the dc voltage measurement function.

Table A-7. PAI Module DC Voltage General Specifications

Specification	Characteristic
Input Impedance	100 M Ω in parallel with 300 pF maximum for ranges ≤ 3 V 10 M Ω in parallel with 100 pF maximum for ranges > 3 V
Normal Mode Rejection	50 dB minimum at 50 Hz/60 Hz $\pm 0.1\%$, Slow Rate
Common Mode Rejection	120 dB minimum at dc, 50 Hz/60 Hz $\pm 0.1\%$, 1 k Ω imbalance, Slow Rate 80 dB minimum at dc, 50 Hz/60 Hz $\pm 0.1\%$, 1 k Ω imbalance, Medium and Fast Rates
Channel-to-Channel Cross talk	120 dB minimum Slow Rate (e.g., 30 V dc on channel 1 may cause a 30 μ V error on channel 2) 100 dB minimum Medium and Fast Rates (e.g., 1V dc on channel 1 may cause a 10 μ V error on channel 2)
Temperature Coefficient	For % input: Add 1/10th the 90-day specification per $^{\circ}$ C above 28 $^{\circ}$ C or below 18 $^{\circ}$ C For floor error (V): Add 1/20th the 90-day specification per $^{\circ}$ C above 28 $^{\circ}$ C or below 18 $^{\circ}$ C
Accuracy at -20 $^{\circ}$ C	Multiply the -10 $^{\circ}$ C to +60 $^{\circ}$ C accuracy specification by 2. After 1 hour warm-up. For accuracy between -10 $^{\circ}$ C and -20 $^{\circ}$ C, interpolate linearly.
Maximum Input Voltage	The lesser voltage of: 300 V from any terminal on channels 1 and 11 to earth; 150 V from any terminal on channels 2 through 10, and 12 through 20 to earth; 300 V from any terminal on channels 1 and 11 to any other terminal; 150 V from any terminal on channels 2 through 10, and 12 through 20 to any other input terminal

Table A-8. PAI Module DC Voltage Range and Resolution Specifications

Range	Resolution	
	Slow	Fast
90 mV	0.3 μ V	1 μ V
300 mV	1 μ V	3 μ V
3 V	10 μ V	30 μ V
30 V	100 μ V	300 μ V
150/300 V	1 mV	3 mV

Note 300 V range applies to channels 1 and 11 only.

Table A-9. PAI Module DC Voltage Accuracy Specifications

Range	Accuracy, $3\sigma \pm$ (% input + V)					
	18 °C to 28 °C				-10 °C to 60 °C	
	90 Day		1 Year		1 Year	
	Slow	Fast	Slow	Fast	Slow	Fast
90 mV	.01%+7 μ V	.01%+17 μ V	.013%+8 μ V	.013%+18 μ V	.042%+18.2 μ V	.042%+44.2 μ V
300 mV	.01%+15 μ V	.01%+30 μ V	.013%+17 μ V	.013%+35 μ V	.042%+39 μ V	.042%+78 μ V
750 mV*	.01%+40 μ V	.01%+70 μ V	.013%+50 μ V	.013%+80 μ V	.042%+104 μ V	.042%+182 μ V
3 V	.01%+0.1 mV	.01%+0.2 mV	.013%+0.15 mV	.013%+0.2 mV	.042%+0.26 mV	.042%+0.52 mV
30 V	.01%+1.5 mV	.02%+3 mV	.013%+1.7 mV	.026%+3.5 mV	.042%+3.9 mV	.084%+7.8 mV
150/300 V*	.01%+15 mV	.04%+30 mV	.013%+17 mV	.052%+35 mV	.042%+39 mV	.168%+78 mV

Note 300 V range applies to channels 1 and 11 only.

PAI Module AC Voltage Measurement Specifications

The following tables provide PAI Module specifications for the ac voltage measurement function.

Table A-10. PAI Module AC Voltage General Specifications

Specification	Characteristic
Input Impedance	1 M Ω in parallel with 100 pF
Maximum Crest Factor	3.0 Maximum 2.0 for rated accuracy
Crest Factor Error	For nonsinusoidal input signals with crest factors between 2 and 3 and pulse widths $\geq 100 \mu\text{s}$, add 0.2% to the accuracy specifications.
Common Mode Rejection	80 dB minimum at dc, 50 Hz/60 Hz $\pm 0.1\%$, 1 k Ω imbalance, Slow Rate
Maximum Input Voltage	The lesser voltage of: 300 V ac rms from any terminal on channels 1 and 11 to earth. 150 V ac rms from any terminal on channels 2 through 10, and 12 through 20 to earth. 300 V ac rms from any terminal on channels 1 and 11 to any other terminal. 150 V ac rms from any terminal on channels 2 through 10 and 12 through 20 to any other input terminal.
Maximum Volt-Hertz Product	2x10 ⁶ Volt-Hertz product on any range, normal mode input. 1x10 ⁶ Volt-Hertz product on any range, common mode input.
Temperature Coefficient	Linear interpolation between 2 applicable points for temperatures between 28 °C and 60 °C, or -10 °C and 18 °C, e.g., if the applicable specification at 28 °C is 2% and the specification at 60 °C is 3%, then the specification at 40 °C is $(3\%-2\%)\times(40-28)/(60-28)+2\%=2.375\%$.
Accuracy at -20 °C	Multiply the -10 °C to +60 °C accuracy specification by 2. After 1 hour warm-up. For accuracy between -10 °C and -20 °C, interpolate linearly.
DC Component Error	The presence of a dc voltage will cause an indeterminate error in the reading of the ac voltage on the input.

Table A-11. PAI Module AC Voltage Range and Resolution Specifications

Range	Resolution		Minimum Input for Rate Accuracy
	Slow	Fast	
Full Scale	±30,000	±3,000	
300 mV	10 µV	100 µV	20 mV
3 V	100 µV	1 mV	200 mV
30 V	1 mV	10 mV	2 V
150/300 V	10 mV	100 mV	20 V
Note 300 V range applies to channels 1 and 11 only.			

Table A-12. PAI Module AC Voltage Accuracy Specifications

Range	Frequency	1 Year Accuracy \pm (%input + V) [1]			
		18 °C to 28 °C		-10 °C to 60 °C	
		Slow	Fast	Slow	Fast
300 mV	20 to 50 Hz	3%+.25 mV	6%+.5 mV	3.5%+.25 mV	7%+.5 mV
	50 to 150 Hz	0.4%+.25 mV	1%+.5 mV	0.5%+.25 mV	1.5%+.5 mV
	150 Hz to 10 kHz	0.3%+.25 mV	1%+.5 mV	0.4%+.25 mV	1.5%+.5 mV
	10 kHz to 20 kHz	0.4%+.25 mV	1%+.5 mV	0.7%+.25 mV	1.5%+.5 mV
	20 kHz to 50 kHz	2%+.3 mV	3%+.5 mV	3%+.3 mV	4%+.5 mV
	50 kHz to 100 kHz	5%+.5 mV	5%+1 mV	7%+.5 mV	8%+1 mV
3 V	20 to 50 Hz	3%+2.5 mV	6%+5 mV	3.5%+2.5 mV	7%+5 mV
	50 to 150 Hz	0.4%+2.5 mV	1%+5 mV	0.5%+2.5 mV	1.2%+5 mV
	150 Hz to 10 kHz	0.3%+2.5 mV	1%+5 mV	0.4%+2.5 mV	1.2%+5 mV
	10 kHz to 20 kHz	0.4%+2.5 mV	1%+5 mV	0.5%+2.5 mV	1.2%+5 mV
	20 kHz to 50 kHz	1%+3 mV	1.5%+6 mV	1.5%+3 mV	2%+6 mV
	50 kHz to 100 kHz	2%+5 mV	3%+10 mV	3%+5 mV	4%+10 mV
30 V	20 to 50 Hz	3%+25 mV	6%+50 mV	3.5%+25 mV	7%+50 mV
	50 to 150 Hz	0.4%+25 mV	1%+50 mV	0.5%+25 mV	1.2%+40 mV
	150 Hz to 10 kHz	0.3%+25 mV	1%+50 mV	0.5%+25 mV	1.2%+40 mV
	10 kHz to 20 kHz	0.4%+25 mV	1%+50 mV	0.5%+25 mV	1.2%+40 mV
	20 kHz to 50 kHz	1%+30 mV	1.5%+60 mV	1%+30 mV	2%+50 mV
	50 kHz to 100 kHz, V<20V	2%+50 mV	3%+100 mV	2.5%+50 mV	4%+100 mV
150/300 V	20 to 50 Hz	3%+.25 V	6%+.5 V	3.5%+.25 V	7%+.5 V
	50 to 150 Hz	0.4%+.25 V	1%+.5 V	0.5%+.25 V	1.2%+.4 V
	150 Hz to 2 kHz Vx Hz<2 x10 ⁶	0.3%+.25 V	1.2%+.5 V	0.5%+.25 V	1.4%+.4 V
	2 kHz to 20 kHz, V<100V	0.4%+.25 V	1.6%+.5 V	0.5%+.25 V	1.8%+.4 V
	20 kHz to 50 kHz, V<40V	1%+.30 V	2.0%+.6 V	1.2%+.30 V	2.5%+.5 V

[1] Sinewave inputs>6% of scale and signals with crest factors <2.

PAI Module 4-Wire Resistance Measurement Specifications

The following tables provide PAI Module specifications for the 4-wire resistance measurement function. The 4-wire measurements use 2 input channels a decade apart, e.g., channels 4 and 14.

Table A-13. PAI Module 4-Wire Resistance Temperature Coefficient

Specification	Characteristic
Temperature Coefficient	Add 1/10th the 90 day specification per °C above 28 °C or below 18 °C.
Accuracy at -20 °C	Multiply the -10 °C to +60 °C accuracy specification by 2. After 1 hour warm-up. For accuracy between -10 °C and -20 °C, interpolate linearly.

Table A-14. PAI Module 4-Wire Resistance Range and Resolution Specifications

Range	Resolution		Current Applied	Full Scale Voltage	Maximum Voltage Applied by Instrument
	Slow	Fast			
300 Ω	1 mΩ	3mΩ	1 mA	300 mV	3.5 V
3 kΩ	10 mΩ	30 mΩ	100 μA	300 mV	3.5 V
30 kΩ	100 mΩ	300 mΩ	10 μA	300 mV	3.5 V
300 kΩ	1 Ω	3 Ω	10 μA	3.0 V	3.5 V
3 MΩ	10 Ω	30 Ω	1 μA	3.0 V	3.5 V

Table A-15. PAI Module 4-Wire Resistance Accuracy Specifications

Range	Accuracy, $3\sigma \pm$ (% input + V)					
	18 °C to 28 °C				-10 °C to 60 °C	
	90 Day		1 Year		1 Year	
	Slow	Fast	Slow	Fast	Slow	Fast
300 Ω	.015%+20 m Ω	.02%+80 m Ω	.02%+50 m Ω	.02%+120 m Ω	.084%+126 m Ω	.084%+336 m Ω
3 k Ω	.02%+.3 Ω	.02%+.8 Ω	.02%+.5 Ω	.02%+1.2 Ω	.084%+1.26 Ω	.084%+3.36 Ω
30 k Ω	.03%+3 Ω	.04%+10 Ω	.03%+5 Ω	.04%+15 Ω	.126%+12.6 Ω	.168%+42 Ω
300 k Ω	.1%+40 Ω	.2%+100 Ω	.1%+60 Ω	.2%+150 Ω	.42%+168 Ω	.84%+420 Ω
3 M Ω [1]	.25%+800 Ω	.5%+10 k Ω	.25%+1 k Ω	.5%+1.5 k Ω	1.05%+3.36 k Ω	2.1%+4.2 k Ω
<p>[1] The 3 MΩ range is susceptible to the absorption of humidity under extreme conditions. If the instrument is operated normally within its specified temperature-humidity range, the 3 MΩ range meets its accuracy specifications. However, if the instrument is "soaked" at 50 °C, 90% relative humidity, the 3 MΩ range may require 1 hour of "dry-out" time at 25 °C, <40% relative humidity for each hour of soak time in order to achieve its specified accuracy.</p>						

PAI Module 2-Wire Resistance Measurement Specifications

The PAI Module specifications for the two-wire resistance measurement function is based on the four-wire resistance measurement specification (above) except you add a nominal 5 Ω (10 Ω maximum) positive offset. This value varies for each channel and with temperature (nominal +1%/°C).

PAI Module 4-Wire RTD per ITS-1990 Measurement Specifications

The following tables provide PAI Module specifications for the 4-wire Resistance-Temperature Detector (RTD) measurement function. The 4-wire measurements use 2 input channels a decade apart, e.g., channels 4 and 14.

Table A-16. PAI Module 4-Wire RTD Temperature Coefficient

Specification	Characteristic
Temperature Coefficient	To calculate RTD accuracy for temperatures between 28 °C and 60 °C, or -10 °C and 18 °C, use a linear interpolation between the two applicable points. For example, if the applicable specification at 28 °C is 0.2 and the specification at 60 °C is 0.75, then the specification at 40 °C is $=(.75-.2)(40-28)/(60-28)+.2=0.406$.
Accuracy at -20 °C	Multiply the -10 °C to +60 °C accuracy specification by 2. After 1 hour warm-up. For accuracy between -10 °C and -20 °C, interpolate linearly.

Table A-17. PAI Module 4-Wire RTD Specifications

Temperature	Resolution		Accuracy, 3σ				
			90 Day 18 °C to 28 °C		1 Year 18 °C to 28 °C	1 Year -10 °C to 60 °C	
	Slow	Fast	Slow	Fast	Slow	Slow	Fast
-200 °C	0.003 °C	0.007 °C	0.06 °C	0.16 °C	0.09 °C	0.33 °C	0.63 °C
0 °C	0.003 °C	0.007 °C	0.09 °C	0.20 °C	0.13 °C	0.53 °C	0.86 °C
100 °C	0.003 °C	0.007 °C	0.10 °C	0.23 °C	0.16 °C	0.63 °C	0.97 °C
300 °C	0.003 °C	0.007 °C	0.14 °C	0.30 °C	0.21 °C	0.83 °C	1.20 °C
600 °C	0.003 °C	0.007 °C	0.19 °C	0.53 °C	0.30 °C	1.20 °C	1.60 °C

PAI Module 2-Wire RTD per ITS-1990 Measurement Specifications

The PAI Module specifications for the two-wire Resistance Temperature Detector (RTD) measurement function is based on the four-wire RTD measurement specification (above) except you add a nominal 5 Ω (approximately 13 °C) positive offset. This value varies for each channel and temperature gradient (nominal +1%/°C). Also note that the resistance of the RTD wiring adds directly to the error. After 100 million operations of a measurement channel, the offset will increase at an indeterminate rate.

PAI Module Thermocouple per ITS-1990 Measurement Specifications

The following tables provide PAI Module specifications for the thermocouple measurement function per ITS-1990.

Table A-18. PAI Module Thermocouple General Specifications

Specification	Characteristic
Input Impedance	100 M Ω minimum in parallel with 300 pF
Open Thermocouple Detect	Operates by injecting a small ac signal into the input after each measurement. A thermocouple resistance greater than 1k to 10k is detected as an open input.
Temperature Coefficient	To calculate Thermocouple accuracy for temperatures between 28 °C and 60 °C, or -10 °C and 18 °C, use a linear interpolation between the two applicable points. For example, if the applicable specification at 28 °C is 0.6 and the specification at 60°C is 1.1, then the specification at 40°C is $= (1.1 - 0.6) \times (40 - 28) / (60 - 28) + 0.6 = 0.7875$.
Accuracy at -20 °C	Multiply the -10 °C to +60 °C accuracy specification by 2. After 1 hour warm-up. For accuracy between -10 °C and -20 °C, interpolate linearly.

Table A-19. PAI Module Thermocouple Specifications

Thermocouple ITS90		Resolution °C	Accuracy ± °C				
			18 °C to 28 °C			-10 °C to 60 °C	
Type	Temperature °C		90 Day	1 Year		1 Year	
		Slow	Slow	Fast	Slow	Fast	
E	-100 to -25	.03	0.45	0.50	0.80	0.60	0.80
	-25 to 20	.02	0.35	0.40	0.60	0.50	0.70
	20 to 600	.02	0.30	0.40	0.60	0.50	0.80
	600 to 1000	.02	0.40	0.50	0.70	0.90	1.00
J	-100 to 80	.03	0.45	0.50	0.80	0.60	0.80
	80 to 230	.02	0.35	0.50	0.70	0.60	0.80
	230 to 760	.02	0.40	0.50	0.70	0.80	0.90
K	-100 to -25	.04	0.55	0.60	0.90	0.70	1.00
	-25 to 120	.03	0.40	0.50	0.80	0.60	0.90
	120 to 800	.03	0.50	0.65	0.90	1.00	1.20
	800 to 1372	.03	0.70	1.00	1.30	1.60	1.90
L	-100 to 100	.04	0.90	1.00	2.00	1.30	2.00
	100 to 800	.04	0.50	0.90	1.40	1.20	1.70
	800 to 900	.03	0.50	0.70	1.10	1.30	1.50
N	-100 to -25	.05	0.65	0.75	1.20	0.80	1.30
	-25 to 120	.05	0.55	0.60	1.00	0.70	1.10
	120 to 1000	.04	0.45	0.60	0.90	1.00	1.20
	1000 to 1300	.03	0.55	0.75	1.00	1.20	1.50
R	250 to 600	0.1	0.90	1.00	2.10	1.20	2.20
	600 to 1500	0.1	0.80	0.90	1.80	1.30	2.00
	1500 to 1767	0.1	0.85	0.85	1.90	1.70	2.50
S	250 to 1000	0.1	0.95	1.10	2.30	1.30	2.40
	1000 to 1400	0.1	0.80	1.00	1.90	1.40	2.30
	1400 to 1767	0.1	1.00	1.30	2.20	1.80	2.80

Table A-19. PAI Module Thermocouple Specifications (cont.)

Thermocouple ITS90		Resolution °C	Accuracy ± °C				
			18 °C to 28 °C			-10 °C to 60 °C	
Type	Temperature °C		90 Day	1 Year		1 Year	
		Slow	Slow	Fast	Slow	Fast	
B	600 to 900	0.2	1.20	1.40	3.10	1.50	3.20
	900 to 1200	0.2	0.90	1.00	2.20	1.20	2.40
	1200 to 1820	0.1	0.75	1.00	1.90	1.30	2.20
C	0 to 150	0.2	0.80	0.90	1.60	1.00	1.70
	150 to 650	0.1	0.65	0.75	1.40	1.00	1.50
	650 to 1000	.05	0.65	0.85	1.40	1.20	1.80
	1000 to 1800	.05	1.00	1.30	2.10	2.10	2.80
	1800 to 2316	.05	1.60	2.10	3.20	3.40	4.60
T	-100 to 0	.04	0.60	0.65	1.00	0.70	1.10
	0 to 150	.03	0.40	0.50	0.80	0.60	0.90
	150 to 400	.02	0.30	0.40	0.60	0.60	0.80
U	-100 to 0	.04	1.50	1.50	2.60	1.60	3.00
	0 to 600	.04	0.60	0.80	1.60	1.10	1.90
Thermistor							
		Accuracy ± °C					
Temp °C	Range*	90 Day		1 Year			
		Slow		Slow			
-40 to 150	100 to 100 mΩ	0.3		0.4		18 to 23 °C	
<p>Steinhart – Hart Equation: $1/(T \text{ °Kelvin}) = A + B*(\ln \Omega) + C*(\ln \Omega)^3$</p> <p>Default constants are supplied only for a YSI (type 004) 2,252 Ω thermistor, you can enter constants for other thermistors. The ranges of thermistor constants are as follows: A 1.0E-4 to 1.0E-2, B 1.0E-5 to 1.0E-3, and C 1.0E-8 to 1.0E-6.</p> <p>*Assumes 4-wire measurement for thermistor resistance values below 2 kΩ (above 28 °C for a 2.252 kΩ thermistor).</p>							

PAI Module Frequency Measurement Specifications

The following tables provide PAI Module specifications for the frequency measurement function.

Table A-20. PAI Module Frequency Accuracy Specifications

Range	Frequency Measurement Accuracy, 1 Year, -10 °C to 60 °C			
	Resolution		Accuracy ± (% input + Hz)	
	Slow	Fast	Slow	Fast
15 Hz to 900 Hz	0.01 Hz	0.1 Hz	0.05%+0.02 Hz	0.05%+0.2 Hz
900 Hz to 9 kHz	0.1 Hz	1 Hz	0.05%+0.1 Hz	0.05%+1 Hz
9 kHz to 90 kHz	1 Hz	10 Hz	0.05%+1 Hz	0.05%+10 Hz
90 kHz to 900 kHz	10 Hz	100 Hz	0.05%+10 Hz	0.05%+100 Hz
1 MHz	100 Hz	1 kHz	0.05%+100 Hz	0.05%+1 kHz

Table A-21. PAI Module Frequency Sensitivity Specifications

Frequency Measurement Sensitivity (Sinewave)		
Frequency Range	Minimum Signal	Maximum Signal
15 Hz to 70 kHz	100 mV ac rms	V<150/300 V rms [1] and Vx Hz<2x10 ⁶)
70 kHz to 100 kHz	100 mV ac rms	20 V ac rms
100 kHz to 200 kHz	150 mV ac rms	10 V ac rms
200 kHz to 300 kHz	150 mV ac rms	7 V ac rms
300 kHz to 1 MHz	Linearly increasing from 150 mV ac rms at 300 kHz to 2 V ac rms at 1 MHz	Linearly decreasing from 7 V ac rms at 300 kHz to 2 V ac rms at 1 MHz
[1] 300 V range applies to channels 1 and 11 only.		

Fast Analog Input (FAI) Module Specifications

This section includes specifications specific to the FAI Module instrument by measurement function.

FAI Module DC Voltage Measurement Specifications

The following tables provide FAI Module specifications for the dc voltage measurement function.

Table A-22. FAI Module DC Voltage General Specifications

Specification	Characteristic
Input Impedance	100 M Ω in parallel with 300 pF maximum for ranges ≤ 3 V 10 M Ω in parallel with 100 pF maximum for ranges > 3 V
Normal Mode Rejection	50 dB minimum at 50 Hz/60 Hz $\pm 0.1\%$, Slow Rate
Common Mode Rejection	120 dB minimum at dc, 50 Hz/60 Hz $\pm 0.1\%$, 1 k Ω imbalance, Slow Rate 80 dB minimum at dc, 60 dB at 50 Hz/60 Hz $\pm 0.1\%$, 1 k Ω imbalance, Medium and Fast Rates
Channel-to-Channel Crosstalk	120 dB minimum Slow Rate (e.g., 30 V dc on channel 1 may cause a 30 μ V error on channel 2) 80 dB minimum Medium and Fast Rates (e.g., 1 V dc on channel 1 may cause a 10 μ V error on channel 2)
Temperature Coefficient	For % input: Add 1/10th the 90-day specification per $^{\circ}$ C above 28 $^{\circ}$ C or below 18 $^{\circ}$ C. For floor error (V): Add 1/20th the 90-day specification per $^{\circ}$ C above 28 $^{\circ}$ C or below 18 $^{\circ}$ C.
Accuracy at -20 $^{\circ}$ C	Multiply the -10 $^{\circ}$ C to +60 $^{\circ}$ C accuracy specification by 2. After 1 hour warm-up. For accurate between -10 $^{\circ}$ C and -20 $^{\circ}$ C, interpolate linearly.
Maximum Input Voltage	The lesser voltage of: 50 V dc or 30 V ac rms from any input terminal to earth -or- 50 V dc or 30 V ac rms from any input terminal to any other input terminal

Table A-23. FAI Module DC Voltage Resolution and Repeatability Specifications

Range	Resolution	
	Slow	Fast
90 mV	3 μ V	6 μ V
300 mV	1 μ V	3 μ V
3 V	10 μ V	30 μ V
30 V	100 μ V	300 μ V
50 V	1 mV	3 mV

Table A-24. FAI Module DC Voltage Accuracy Specifications

Range	Accuracy, $3\sigma \pm$ (% input + V)					
	18 °C to 28 °C				-10 °C to 60 °C	
	90 Day		1 Year		1 Year	
	Slow	Fast	Slow	Fast	Slow	Fast
90 mV	.01%+20 μ V	.01%+50 μ V	.013%+23 μ V	.013%+50 μ V	.042%+52 μ V	.042%+130 μ V
300 mV	.01%+40 μ V	.01%+90 μ V	.013%+49 μ V	.013%+93 μ V	.042%+104 μ V	.042%+234 μ V
3 V	.01%+.3 mV	.01%+.6 mV	.013%+.38 mV	.013%+.64 mV	.042%+.78 mV	.042%+1.56 mV
30 V	.01%+4 mV	.02%+8 mV	.013%+4.9 mV	.026%+9.5 mV	.042%+10.6 mV	.084%+20.3 mV
50 V	.01%+30 mV	.04%+60 mV	.013%+40 mV	.052%+64 mV	.042%+78 mV	.168%+156 mV

FAI Module AC Voltage Measurement Specifications

The following tables provide FAI Module specifications for the ac voltage function.

Table A-25. FAI Module AC Voltage General Specifications

Specification	Characteristic
Input Impedance	1 M Ω in parallel with 100 pF
Maximum Crest Factor	3.0 maximum; 2.0 for rated accuracy
Crest Factor Error	For nonsinusoidal input signals with crest factors between 2 and 3 and pulse widths $\geq 100 \mu\text{s}$, add 0.2% to the accuracy specifications.
Common Mode Rejection	80 dB minimum at dc, 50 Hz/60 Hz $\pm 0.1\%$, 1 k Ω imbalance, Slow Rate
Maximum Input Voltage	The lesser voltage of: 30 V ac rms from any input terminal to earth. 30 V ac rms from any terminal input to any other input terminal.
Maximum Volt-Hertz Product	2x10 ⁶ Volt-Hertz product on any range, normal mode input. 1x10 ⁶ Volt-Hertz product on any range, common mode input.
Temperature Coefficient	Linear interpolation between 2 applicable points for temperatures between 28 °C and 60 °C, or -10 °C and 18 °C, e.g., if the applicable specification at 28 °C is 2% and the specification at 60 °C is 3%, then the specification at 40 °C is $(3\% - 2\%) \times (40 - 28) / (60 - 28) + 2\% = 2.375\%$.
Accuracy at -20 °C	Multiply the -10 °C to +60 °C accuracy specification by 2. After 1 hour warm-up. For accuracy between -10 °C and -20 °C, interpolate linearly.
DC Component Error	The presence of a dc voltage will cause an indeterminate error in the reading of the ac voltage on the input.

Table A-26. FAI Module AC Voltage Range and Resolution Specifications

Range	Resolution		Minimum Input for Rate Accuracy
	Slow	Fast	
Full Scale	$\pm 30,000$	$\pm 3,000$	
300 mV	10 μV	100 μV	20 mV
3 V	100 μV	1 mV	200 mV
30 V	1 mV	10 mV	2 V

Table A-27. FAI Module AC Voltage Accuracy Specifications

Range	Frequency	1 Year Accuracy \pm (%input + V) [1]			
		18°C to 28°C		-10°C to 60°C	
		Slow	Fast	Slow	Fast
300 mV	20 to 50 Hz	3%+.25 mV	6%+.5 mV	3.5%+.25 mV	7%+.5 mV
	50 to 150 Hz	0.4%+.25 mV	0.8%+.5 mV	0.5%+.25 mV	1%+.5 mV
	150 Hz to 10 kHz	0.3%+.25 mV	0.8%+.5 mV	0.4%+.25 mV	1%+.5 mV
	10 kHz to 20 kHz	0.4%+.25 mV	1%+.5 mV	0.7%+.25 mV	1.5%+.5 mV
	20 kHz to 50 kHz	2%+.3 mV	3%+.5 mV	3%+.3 mV	4%+.5 mV
	50 kHz to 100 kHz	5%+.5 mV	5%+1 mV	7%+.5 mV	8%+1 mV
3 V	20 to 50 Hz	3%+2.5 mV	6%+5 mV	3.5%+2.5 mV	7%+5 mV
	50 to 150 Hz	0.4%+2.5 mV	0.8%+5 mV	0.5%+2.5 mV	1%+5 mV
	150 Hz to 10 kHz	0.3%+2.5 mV	0.6%+5 mV	0.4%+2.5 mV	1%+5 mV
	10 kHz to 20 kHz	0.4%+2.5 mV	0.8%+5 mV	0.5%+2.5 mV	1%+5 mV
	20 kHz to 50 kHz	1%+3 mV	1.5%+6 mV	1.5%+3 mV	2%+6 mV
	50 kHz to 100 kHz	2%+5 mV	3%+10 mV	3%+5 mV	4%+10 mV
30 V	20 to 50 Hz	3%+25 mV	6%+50 mV	3.5%+25 mV	7%+50 mV
	50 to 150 Hz	0.4%+25 mV	0.8%+50 mV	1.2%+25 mV	1.3%+40 mV
	150 Hz to 10 kHz	0.4%+25 mV	0.8%+50 mV	1.2%+25 mV	1.3%+40 mV
	10 kHz to 20 kHz	0.4%+25 mV	0.8%+50 mV	1.2%+25 mV	1.3%+40 mV
	20 kHz to 50 kHz	1%+30 mV	1.5%+60 mV	1.2%+30 mV	2%+50 mV
	50 kHz to 100 kHz, V<20V	2%+50 mV	3%+100 mV	2.5%+50 mV	4%+100 mV
[1] Sinewave inputs>6% of scale and signals with crest factors <2.					

FAI Module 4-Wire Resistance Measurement Specifications

The following tables provide FAI Module specifications for the 4-wire resistance measurement function. The 4-wire measurements use 2 input channels a decade apart, e.g., channels 4 and 14.

Table A-28. FAI Module 4-Wire Resistance Temperature Coefficient

Specification	Characteristic
Temperature Coefficient	Add 1/10th the 90 day specification per °C above 28 °C or below 18 °C.
Accuracy at -20 °C	Multiply the -10 °C to +60 °C accuracy specification by 2. After 1 hour warm-up. For accuracy between -10 °C and -20 °C, interpolate linearly.

Table A-29. FAI Module 4-Wire Resistance Range and Resolution Specifications

Range	Resolution		Current Applied	Full Scale Voltage	Maximum Voltage Applied by Instrument
	Slow	Fast			
300 Ω	10 m Ω	30 m Ω	1 mA	300 mV	3.5 V
3 k Ω	100 m Ω	300 m Ω	100 μ A	300 mV	3.5 V
30 k Ω	1 Ω	3 Ω	10 μ A	300 mV	3.5 V
300 k Ω	10 Ω	30 Ω	10 μ A	3.0 V	3.5 V
3 M Ω	100 Ω	300 Ω	1 μ A	3.0 V	3.5 V

Table A-30. FAI Module 4-Wire Resistance Accuracy Specifications

Range	Accuracy, $3\sigma \pm$ (% input + Ω)					
	18 °C to 28 °C				-10 °C to 60 °C	
	90 Day		1 Year		1 Year	
	Slow	Fast	Slow	Fast	Slow	Fast
300 Ω	.02%+60 m Ω	.02%+.1 Ω	.02%+.1 Ω	.02%+.2 Ω	.084%+.25 Ω	.084%+.42 Ω
3 k Ω	.02%+.6 Ω	.02%+2 Ω	.02%+1 Ω	.02%+3 Ω	.084%+2.5 Ω	.084%+8.4 Ω
30 k Ω	.02%+6 Ω	.2%+200 Ω	.02%+10 Ω	.2%+300 Ω	.084%+25 Ω	.84%+840 Ω
300 k Ω	.5%+80 Ω	1%+2 k Ω	.5%+150 Ω	1%+3 k Ω	2.1%+336 Ω	4.2%+8.4 k Ω
3 M Ω	1.3%+1 k Ω	2%+120 k Ω	1.3%+2 k Ω	2%+200 k Ω	5.46%+4.2 k Ω	8.4%+200 k Ω

FAI Module 2-Wire Resistance Measurement Specifications

The FAI Module specifications for the two-wire resistance measurement function is based on the four-wire resistance measurement specification (above) except you add a 100 to 300 Ω positive offset. This value varies for each channel and temperature gradient (nominal +1%/°C). Only 30 k, 300 k, and 3 M ranges are available in 2-wire resistance on the FAI Module.

FAI Module 4-Wire RTD per ITS-1990 Measurement Specifications

The next tables provide FAI Module specifications for the 4-wire Resistance-Temperature Detector (RTD) measurement function. The 4-wire measurements use 2 input channels a decade apart, e.g., channels 4 and 14. There is no 2-wire RTD capability for the FAI Module.

Table A-31. FAI Module 4-Wire RTD Temperature Coefficient

Specification	Characteristic
Temperature Coefficient	To calculate RTD accuracy for temperatures between 28 °C and 60 °C, or -10 °C and 18 °C, use a linear interpolation between the two applicable points. For example, if the applicable specification at 28 °C is 0.2 and the specifications at 60 °C is 0.75, then the specification at 40 °C = $(.75-.2) \times (40-28) / (60-28) + .2 = .406$.
Accuracy at -20 °C	Multiply the -10 °C to +60 °C accuracy specification by 2. After 1 hour warm-up. For accuracy between -10 °C and -20 °C, interpolate linearly.

Table A-32. FAI Module 4-Wire RTD Specifications

Temperature	Resolution		Accuracy, $3\sigma \pm ^\circ\text{C}$				
			90 Day 18 °C to 28 °C		1 Year 18 °C to 28 °C	1 Year -10 °C to 60 °C	
	Slow	Fast	Slow	Fast	Slow	Slow	Fast
-200 °C	0.03 °C	0.06 °C	0.16 °C	0.25 °C	0.25 °C	0.62 °C	1.10 °C
0 °C	0.03 °C	0.06 °C	0.20 °C	0.31 °C	0.31 °C	0.85 °C	1.30 °C
100 °C	0.03 °C	0.06 °C	0.23 °C	0.34 °C	0.34 °C	0.95 °C	1.40 °C
300 °C	0.03 °C	0.06 °C	0.30 °C	0.41 °C	0.41 °C	1.18 °C	1.70 °C
600 °C	0.03 °C	0.06 °C	0.53 °C	0.63 °C	0.63 °C	1.62 °C	2.12 °C

FAI Module Thermocouple per ITS-1990 Measurement Specifications

The following tables provide FAI Module specifications for the thermocouple measurement function per ITS-1990.

Table A-33. FAI Module Thermocouple General Specifications

Specification	Characteristic
Input Impedance	100 M Ω minimum in parallel with 300 pF
Open Thermocouple Detect	Operates by injecting a small ac signal into the input after each measurement. A thermocouple resistance greater than 1 k Ω to 10 k Ω is detected as an open input.
Temperature Coefficient	To calculate Thermocouple accuracy for temperatures between 28 °C and 60 °C, or -10 °C and 18 °C, use a linear interpolation between the two applicable points. For example, if the applicable specification at 28 °C is 0.6 and the specification at 60 °C is 1.1, then the specification at 40 °C is $=(1.1-0.6)\times(40-28)/(60-28)+0.6=0.7875$.
Accuracy at -20 °C	Multiply the -10 °C to +60 °C accuracy specification by 2. After 1 hour warm-up. For accuracy between -10 °C and -20 °C, interpolate linearly.

Table A-34. FAI Module Thermocouple Specifications

Thermocouple ITS90		Resolution °C	Accuracy ± °C				
			18 °C to 28 °C			-10°C to 60 °C	
Type	Temperature °C		90 Day	1 Year		1 Year	
		Slow	Slow	Fast	Slow	Fast	
E	-100 to -25	.3	0.80	0.90	1.50	1.00	1.60
	-25 to 20	.2	0.70	0.70	1.20	0.80	1.30
	20 to 600	.2	0.60	0.70	1.10	0.80	1.20
	600 to 1000	.2	0.60	0.80	1.20	1.10	1.50
J	-100 to 80	.3	0.80	0.90	1.60	0.90	1.70
	80 to 230	.2	0.70	0.80	1.40	0.90	1.50
	230 to 760	.2	0.70	0.80	1.30	1.00	1.50
K	-100 to -25	.4	1.00	1.10	2.00	1.20	2.10
	-25 to 120	.3	0.80	0.90	1.70	1.00	1.80
	120 to 1000	.3	0.90	1.10	1.80	1.50	2.20
	1000 to 1372	.3	1.20	1.50	2.30	2.00	2.90
L	-100 to 100	.4	1.20	1.30	2.90	1.60	3.10
	100 to 800	.4	0.90	1.00	2.10	1.20	2.30
	800 to 900	.3	0.70	0.80	1.30	1.00	1.50
N	-100 to -25	.5	1.40	1.50	2.80	1.50	2.90
	-25 to 120	.5	1.10	1.30	2.30	1.30	2.40
	120 to 1000	.4	1.00	1.10	2.00	1.20	2.10
	1000 to 1300	.3	1.00	1.20	1.90	1.60	2.40
R	250 to 600	1	2.40	2.70	5.60	2.80	5.70
	600 to 1500	1	2.00	2.30	4.60	2.40	4.80
	1500 to 1767	1	2.00	2.30	4.50	2.80	5.10
S	250 to 1000	1	2.60	2.80	5.90	2.90	6.00
	1000 to 1400	1	2.00	2.30	4.60	2.60	5.00
	1400 to 1767	1	2.30	2.70	5.30	3.30	5.90

Table A-34. FAI Module Thermocouple Specifications (cont.)

Thermocouple ITS90		Resolution °C	Accuracy ± °C				
			18 °C to 28 °C			-10 °C to 60 °C	
Type	Temperature °C		90 Day	1 Year		1 Year	
			Slow	Slow	Fast	Slow	Fast
B	600 to 1200	2	3.60	3.90	8.50	4.00	8.60
	1200 to 1550	2	2.10	2.40	5.00	2.60	5.20
	1550 to 1820	1	2.00	2.30	4.70	2.70	5.00
C	0 to 150	2	1.90	2.00	4.00	2.10	4.20
	150 to 650	1	1.60	1.70	3.50	1.80	3.60
	650 to 1000	.5	1.40	1.70	3.20	2.00	3.50
	1000 to 1800	.5	2.00	2.50	4.50	3.20	5.30
	1800 to 2316	.5	3.10	3.80	6.80	5.10	8.10
T	-100 to 0	.4	1.10	1.20	2.20	1.30	2.30
	0 to 150	.3	0.90	1.00	1.70	1.00	1.80
	150 to 400	.2	0.70	0.80	1.40	0.80	1.50
U	-100 to 0	.4	2.00	2.10	4.30	2.20	4.60
	0 to 600	.4	1.30	1.40	2.50	1.60	2.60
Thermistor							
			Accuracy ± °C				
Temp °C	Range*	90 Day		1 Year			
		Slow		Slow			
-40 to 150	100 to 100 mΩ	0.4		0.51	18 to 23 °C		
Steinhart – Hart Equation: $1/(T \text{ °Kelvin}) = A + B*(\ln \Omega) + C*(\ln \Omega)^3$							
Default constants are supplied only for a YSI (type 004) 2,252 Ω thermistor, you can enter constants for other thermistors. The ranges of thermistor constants are as follows: A 1.0E-4 to 1.0E-2, B 1.0E-5 to 1.0E-3, and C 1.0E-8 to 1.0E-6.							
* Assumes 4-wire measurement.							

FAI Module Frequency Measurement Specifications

The following tables provide FAI Module specifications for the frequency measurement function.

Table A-35. FAI Module Frequency Accuracy Specifications

Range	Frequency Measurement Accuracy, 1 Year, -10 °C to 60 °C			
	Resolution		Accuracy ± (% input + Hz)	
	Slow	Fast	Slow	Fast
15 Hz to 900 Hz	0.01 Hz	0.1 Hz	0.05%+0.02 Hz	0.05%+0.2 Hz
900 Hz to 9 kHz	0.1 Hz	1 Hz	0.05%+0.1 Hz	0.05%+1 Hz
9 kHz to 90 kHz	1 Hz	10 Hz	0.05%+1 Hz	0.05%+10 Hz
90 kHz to 900 kHz	10 Hz	100 Hz	0.05%+10 Hz	0.05%+100 Hz
1 MHz	100 Hz	1 kHz	0.05%+100 Hz	0.05%+1 kHz

Table A-36. FAI Module Frequency Sensitivity Specifications

Frequency Range	Minimum Signal	Maximum Signal
15 Hz to 70 kHz	100 mV ac rms	30 V ac rms
70 kHz to 100 kHz	100 mV ac rms	20 V ac rms
100 kHz to 200 kHz	150 mV ac rms	10 V ac rms
200 kHz to 300 kHz	150 mV ac rms	7 V ac rms
300 kHz to 1 MHz	Linearly increasing from 150 mV ac rms at 300 kHz to 2 V ac rms at 1 MHz	Linearly decreasing from 7 V ac rms at 300 kHz to 2 V ac rms at 1 MHz

Digital Input/Output Module

The following specifications apply to the DIO Module. The module contains digital inputs, digital open collector outputs, relay contacts, and totalizer.

⚠⚠ Warning

The DIO module is rated as a CAT I device.

Digital Input/Output Specifications

Table specifications provides a summary of the Digital I/O specifications for the 10 Digital I/O lines (0 to 19). Digital I/O is located on the Output Module Digital connector, terminals 0 to 19, and GND.

Table A-37. DIGITAL I/O Specification

Specification	Characteristic
Maximum Input Voltage	30 V
Minimum Input Voltage	-4 V
Isolation	None (dc coupled)
Threshold	1.4 V
Hysteresis	500 mV
Output Voltage - TTL Logical Zero	0.8 V maximum for an lout of -1.0 mA (1 LSTTL load)
Output Voltage - TTL Logical One	3.8 V minimum for an lout of 0.05 mA (1 LSTTL load)
Output Voltage - Non-TTL Load Zero	1.8 V maximum for an lout of -20 mA 3.25 V maximum for an lout of -50 mA

Totalizer Input Specifications

The following table provides a summary of the Totalizer Input specifications. The Totalizer Input is located on the Output Module connector, terminals Σ and GND. The totalizer is enabled or disabled by an input on a separate digital input, terminal Σ en. The voltage, isolation, threshold, and hysteresis specifications are the same for the totalizer and enable inputs.

Table A-38. Totalizer Specification

Specification	Characteristic
Maximum Input Voltage	30 V
Minimum Input Voltage	-4 V
Minimum Peak Voltage	2 V
Isolation	None (ac coupled)
Threshold	1.4 V
Hysteresis	500 mV
Input Debouncing	None or 1.75 ms (selectable)
Maximum Transition Rate	5 kHz (Debounce disabled) 500 Hz (Debounce enabled)
Maximum Count for Totalizer	4,294,967,295

Digital Relay Specifications

The next table provides a summary of the relay specifications for the 8 relay contact pairs on the output card. Relay contacts are located on the Output Module connector, two pairs of contacts per relay, on terminals KnA and KnB (where n is the relay number).

Table A-39. DIGITAL I/O Relay Specification

Specification	Characteristic
Maximum Contact Voltage	250 V ac
Minimum Peak Current	2 A at 30 V dc, 0.4 A at 125 V ac (resistive)
Isolation	1.5 kV between contacts and coil
Debounce time (typical)	5 ms
Contact Operate/release Rate	4 ms max
Fuse	2 A, 250 V, 5mm x 20mm, Fast Blow Fuse

Block Diagrams

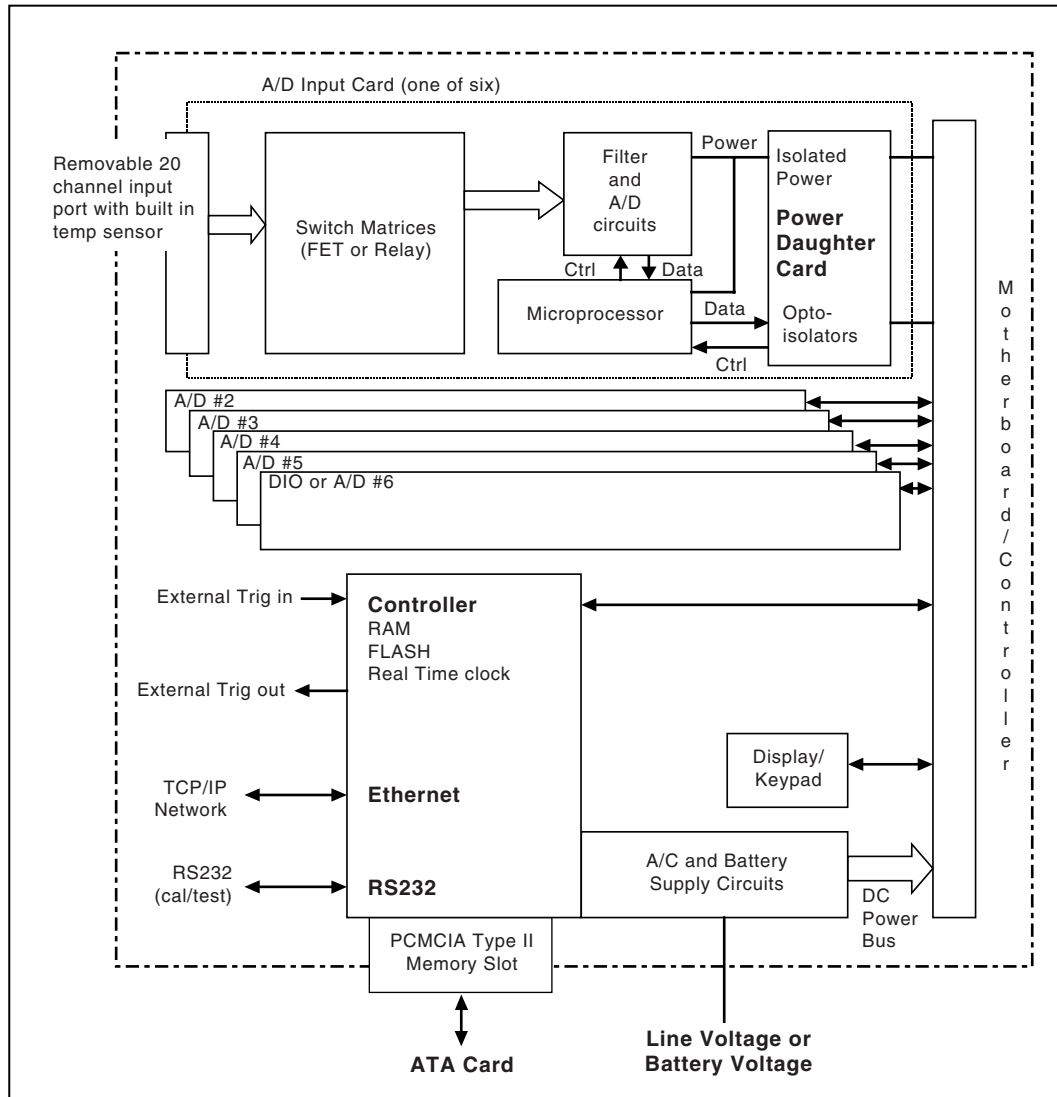
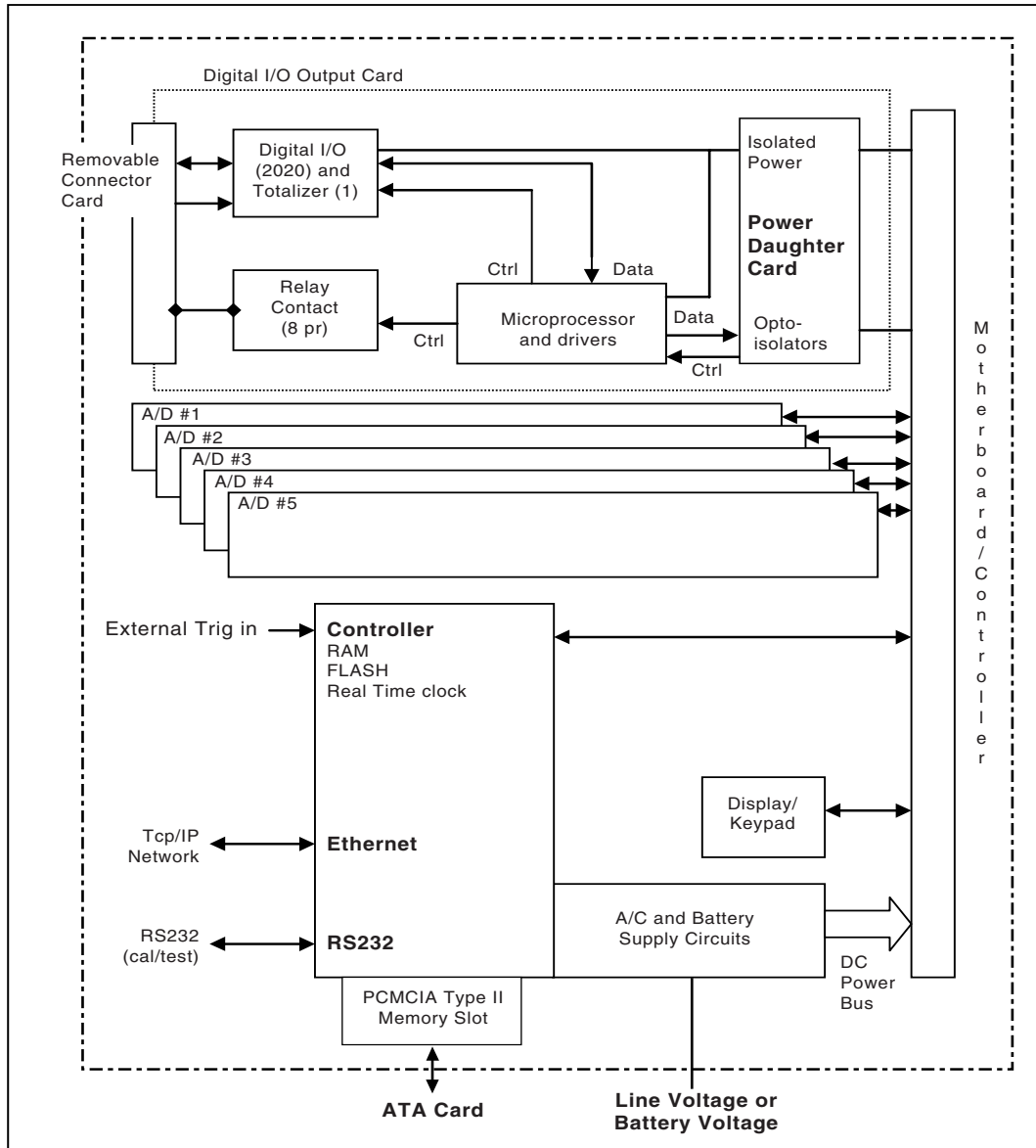

Figure A-1. 2680 Series Chassis

alg50f.eps



alg51f.eps

Figure A-1. 2680 Series Chassis (cont)

Appendix B Noise, Shielding, and Crosstalk Considerations

Introduction

This appendix supplies information on how you can setup your instruments to minimize measurement errors. The topics include static versus dynamic measurement, noise and shielding, and how to minimize crosstalk effects

Static Versus Dynamic Measurements

Some signals change value slowly. Other change rapidly. At some point, things change quickly enough that we call the signals dynamic rather than static.

Frequently, one wishes to analyze dynamic signals in the frequency domain. However, if you wish to do that, you must use an anti-aliasing filter (a low pass filter with a sharp cutoff above the highest frequency of interest) ahead of every input that is to be digitized and you must sample at a frequency at least two times that of the transition band of the filter.

The 2680 Series instruments do not have an anti-aliasing filter built-in. They are not suitable for digitizing dynamic signals unless you put a suitable anti-aliasing filter in series with each input. Note that a suitable anti-aliasing filter is a low-pass filter with at least 3 poles and a fairly sharp cutoff characteristic. Good anti-aliasing filters have as many as 8 poles.

Noise and Shielding

An additional manifestation of aliasing can appear even in static readings. If there is noise coupled into the signal wiring from power mains wiring, it usually appears as noise in the readings. However, it is possible to accidentally combine a fast

reading rate and scan interval that is an exact multiple of the power line period and cause line frequency noise to be aliased to a very low frequency, where it appears as drift, or instability, in the readings. For example, if the instrument is set to Reading Rate = Fast and a scan interval of 100 ms, line frequency noise is aliased because the scan interval is an exact multiple of the period of the power line.

One way to see whether your measurement setup has a potential problem like this is to pick a scan interval like 98 ms or 102 ms, that is not an exact multiple of the power line period. If the readings appear noisier with this scan interval than with an interval of 100 ms, there is a problem with the measurement setup. Possible solutions to this problem are:

1. Use shielded wiring to prevent power line noise pickup from mixing with the signal. Be sure the shield is connected to an earth ground.
2. Route signal wiring away from power mains wiring.
3. Remove noise from the signal using filters before the signal is applied to the instrument.
4. Select Reading Rate = Slow, which allows the instrument to filter out the noise.
5. Ensure that the chassis of the instrument is connected to earth ground. This is desirable for reasons of safety as well as noise.

Crosstalk Considerations

The accuracy of low voltage measurements (e.g., thermocouples), low voltage ac measurements and resistance measurements above 3 k Ω can be greatly affected by undesired pickup from ac voltage sources (crosstalk). To reduce the effects of crosstalk, consider each of the following:

1. **Reading Rate** Do not use Reading Rate = Fast when mixing V ac or frequency inputs with low level V dc, thermocouple, and/or resistance inputs. If you must use Reading Rate = Fast, compare a set of readings taken with Reading Rate = Slow against a set of readings taken on the Fast rate to determine the effects of crosstalk on your setup. Measurements made at the Fast reading rate are more susceptible to crosstalk than readings taken at the Slow reading rate.

Note

When you use the Fast rate, it is very easy to get noise into your readings. The Fast rate makes it possible to look at rapidly changing events, but it requires extreme care to keep the readings clean.

2. **Shielded Wiring** Crosstalk can occur outside the instrument as well as inside the instrument. Use shielded wiring and tie the shields to an earth ground to

prevent noise from being coupled into your measurements. Be careful about the routing of your input wiring: keep it away from or shielded from all ac power mains wiring and other sources of noise.

3. **Channel Spacing** When possible, leave as many unused channels as possible between your ac voltage channel inputs and your low level inputs.

Crosstalk from a V ac or frequency signal on a FAI module channel to an adjacent channel using the slow reading rate is as shown in Table B-1:

Table B-1. FAI Module Crosstalk Specifications.

V ac/Frequency	Volts DC	Resistance	Temperature (100 Ohm RTD)	Temperature (Thermocouple)
<100 Hz	-80 dB	.2%/V if R>3k	.04°/V	.1°/V
100 Hz	-100 dB	.1%/V if R>3k	.02°/V	.003°/V
500 Hz	-100 dB	.1%/V if R>3k	.02°/V	.03°/V
1 kHz	-50 dB	.1%/V if R>3k	.02°/V	.3°/V
2 kHz	-60 dB	.05%/V if R>3k	.02°/V	.1°/V
5 kHz	-66 dB	.1%/V if R>3k	.02°/V	.1°/V
10 kHz	-80 dB	.01%/V	.02°/V	.1°/V
20 kHz	-50 dB	.02%/V	.05°/V	.1°/V
50 kHz	-40 dB	.05%/V	.1°/V	.5°/V
100 kHz	-40 dB	.1%/V	.2°/V	1°/V
>100 kHz	-40 dB	.1%/V	.4°/V	2°/V

Note The temperature ranges are particularly susceptible to crosstalk at frequencies above 20 kHz, and that the error goes up as the square of the voltage, e.g., 2 V ac at 100 kHz can cause a 4 degree error on a thermocouple. Because of this sensitivity, it is not advisable to mix temperature signals and high frequency signals in the same 2680 Series.

Crosstalk from a V ac or frequency signal on a PAI module channel to an adjacent channel using the slow reading rate is as shown in Table B-2.

Table B-2. PAI Module Crosstalk Specifications

Frequency	V dc 1 k Ω source	Resistance		100 Ω RTD	Thermocouple
		R <20 k Ω	R >20 k Ω		
<100 Hz	-120 dB	.001%/V	.01%/V*M Ω	.001 $^\circ$ /V	.001 $^\circ$ /V
100 Hz	-120 dB	.001%/V	.05%/V*M Ω	.001 $^\circ$ /V	.003 $^\circ$ /V
500 Hz	-120 dB	.001%/V	.05%/V*M Ω	.001 $^\circ$ /V	.01 $^\circ$ /V
1 kHz	-100 dB	.001%/V	.05%/V*M Ω	.001 $^\circ$ /V	.01 $^\circ$ /V
2 kHz	-60	.001%/V	.1%/V*M Ω	.001 $^\circ$ /V	.01 $^\circ$ /V ²
5 kHz	.01 mV/V ²	.005%/V ²	Not recomm.	.001 $^\circ$ /V ²	.01 $^\circ$ /V ²
10 kHz	.01 mV/V ²	.005%/V ²	Not recomm.	.01 $^\circ$ /V ²	.05 $^\circ$ /V ²
20 kHz	.05 mV/V ²	.01%/V ²	Not recomm.	.01 $^\circ$ /V ²	Not recomm.
50 kHz	.1 mV/V ²	.01%/V ²	Not recomm.	.01 $^\circ$ /V ²	Not recomm.
100 kHz	.1 mV/V ²	.01%/V ²	Not recomm.	.01 $^\circ$ /V ²	Not recomm.
>500 kHz	.1 mV/V ²	.1%/V ²	Not recomm.	.01 $^\circ$ /V ²	Not recomm.

For frequencies below 5 kHz, the 2680 Series is roughly 10 times more susceptible to crosstalk at frequencies that are exact multiples of 300 Hz than it is at the frequencies shown above. e.g., the sensitivity at 3 kHz will be about 10 times worse than at 2 kHz or 5 kHz.

The above table indicates the amount of crosstalk interference caused by applying V ac to one other channel. If V ac (or frequency) inputs are applied to multiple channels, multiply the value in the table by the number of channels with V ac (or frequency) applied.

Appendix C

True-RMS Measurements

Introduction

The 2680 Series instruments measure the true rms value of ac voltages. In physical terms, the rms (root-mean-square) value of an waveform is the equivalent dc value that causes the same amount of heat to be dissipated in a resistor. True rms measurement greatly simplifies the analysis of complex ac signals. Since the rms value is the dc equivalent of the original waveform, it provides a reliable basis for comparing dissimilar waveforms.

Effects of Internal Noise in AC Measurements

With the input shorted and the instrument set for ac volts (V ac) measurement, internal amplifier noise causes a typical display reading of approximately 0.50 mV ac. Since the instrument is a true rms responding measurement instrument, this noise contributes minimally to the readings at the specified floor of each range. When the rms value of the two signals (internal noise and range floor) is calculated, the effect of the noise is shown as:

$$\text{Total rms digits} = \text{Square Root of } (0.50^2 + 15.00^2) = 15.008$$

The display will read 15.01. At the 28.00 mV input level on the 300.00 mV range in the slow rate, the display will read 28.00 with no observable error.

Waveform Comparison (True RMS vs Average Responding)

Figure C-1 illustrates the relationship between ac and dc components for common waveforms and compares readings for true-rms measurements and average-responding measurements. For example, consider the first waveform, a 1.41421 V (zero-to-peak) sine wave. Both the instrument and rms-calibrated average-responding measurement devices display the correct rms reading of 1.0000 V ac (the dc component equals 0). However, consider the 2 V (peak-to-peak) square wave.

Both types of measurement correctly display the dc component (0 V), but the 2680 Series instrument also correctly measures the ac component (1.0000V). The average-responding device measures 1.11 V, which amounts to an 11% error.

Average-responding measurement instruments have been in use for a long time; you may have accumulated test or reference data based on such instruments. The conversion factors in Figure C-1 can help in converting between the two measurement methods.

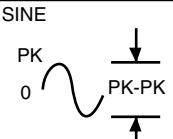
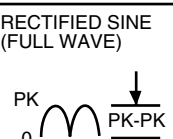
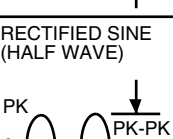
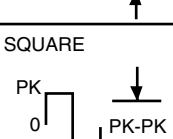
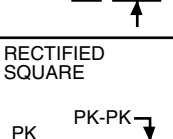
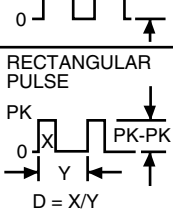
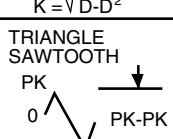
AC-COUPLED INPUT WAVEFORM	PEAK VOLTAGES		MEASURED VOLTAGES			DC AND AC TOTAL RMS
	PK-PK	0-PK	AC COMPONENT ONLY		DC COMPONENT ONLY	TRUE RMS = $\sqrt{ac^2 + dc^2}$
			RMS CAL*	HYDRA		
SINE 	2.828	1.414	1.000	1.000	0.000	1.000
RECTIFIED SINE (FULL WAVE) 	1.414	1.414	0.421	0.436	0.900	1.000
RECTIFIED SINE (HALF WAVE) 	2.000	2.000	0.779	0.771	0.636	1.000
SQUARE 	2.000	1.000	1.111	1.000	0.000	1.000
RECTIFIED SQUARE 	1.414	1.414	0.785	0.707	0.707	1.000
RECTANGULAR PULSE  $D = X/Y$ $K = \sqrt{D-D^2}$	2.000	2.000	$4.442 K^2$	2K	2D	$2\sqrt{D}$
TRIANGLE SAWTOOTH 	3.464	1.732	0.962	1.000	0.000	1.000
* RMS CAL IS THE DISPLAYED VALUE FOR AVERAGE RESPONDING INSTRUMENTS THAT ARE CALIBRATED TO DISPLAY RMS FOR SINE WAVES						

alg71f.eps

Figure C-1. Comparison of Common Waveforms

Appendix D

RTD Linearization

Introduction

This appendix discusses Fixed-385 and Custom-385 RTD measurements with the 2680 Series.

Fixed-385 RTD

The Fixed-385 RTD linearization uses segmented polynomials to approximate the Callendar Van-Dusen equation for a 385 RTD. R_0 may be specified using the Fluke DAQ software, but α , δ , and β are fixed. These fixed coefficients are the modified DIN 43760 coefficients that conform to ITS90:

$$\begin{aligned}\alpha &= 0.00385055 \\ \delta &= 1.49978574 \\ \beta &= 0.10863383\end{aligned}$$

The accuracy specifications of Fixed-385 measurements with a 385 RTD that matches the above coefficients are shown in Table A-15 (for a PAI module) and Table A-32 (for an FAI module) in Appendix A.

Custom-385 RTD

The Custom-385 RTD linearization solves the Callendar Van-Dusen equation for positive temperatures and uses a polynomial approximation to the Callendar Van-Dusen equation for negative temperatures. In addition to R_0 , α may also be specified using the Fluke DAQ software. δ and β are fixed. These fixed coefficients are the modified DIN 43760 coefficients that conform to ITS90:

$$\delta = 1.49978574$$
$$\beta = 0.10863383$$

Figure D-1 shows the accuracy envelope for a 385 RTD that has δ and β that match the above coefficients. Because of the error introduced by the linearization at low temperatures, it is recommended that use of the Custom-385 RTD type be limited to temperatures between -100 and 600 °C.

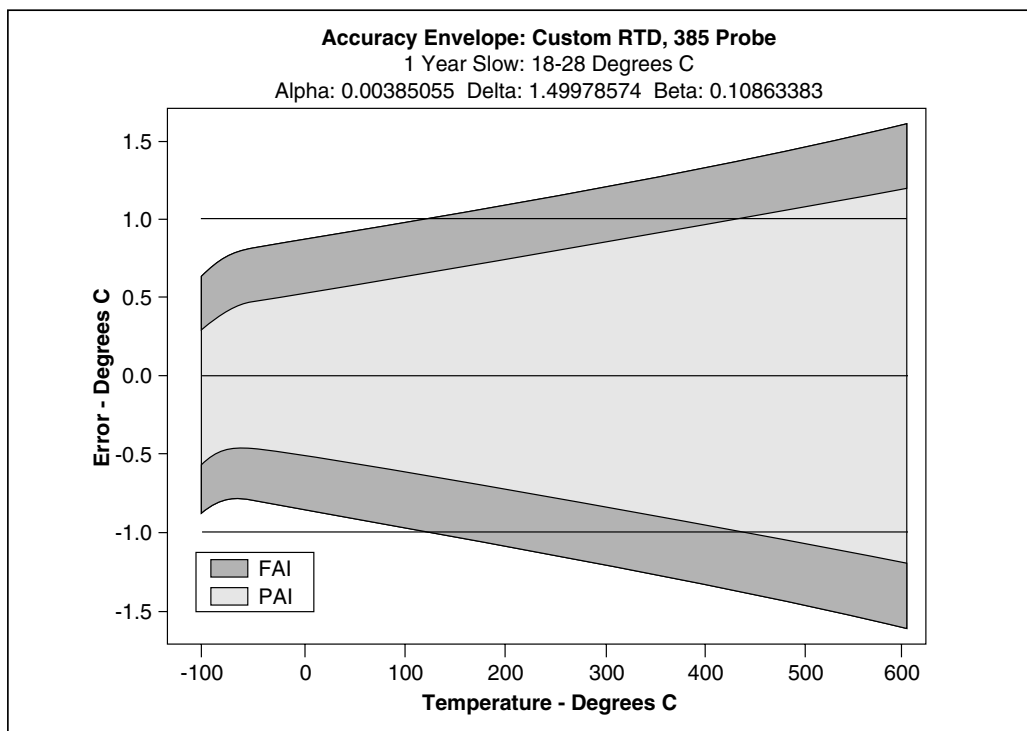

Figure D-1. 385 RTD

alg61f.eps

Using the Custom-385 RTD with Other Platinum RTDs

Although the Custom-385 RTD linearization uses a β and δ from a 385 RTD, other RTD types can be used. The Custom-385 linearization will compensate for the change in α , but errors will be introduced due to the difference in the δ and β coefficients of the RTD and the fixed coefficients. Figure D-2 shows the accuracy envelope for a 375 RTD. Because of the error introduced by the approximation and the difference in δ it is recommended that the use of the 375 RTD be limited to temperatures between -100 °C and 300 °C. Figure D-3 shows the accuracy envelope for a 391 RTD and Figure D-4 shows the accuracy envelope for a 392 RTD. Due to errors introduced by the approximation and the difference in δ it is recommended that the use of the 391 RTD and 392 RTD be limited to temperatures between -100 °C and 600 °C.

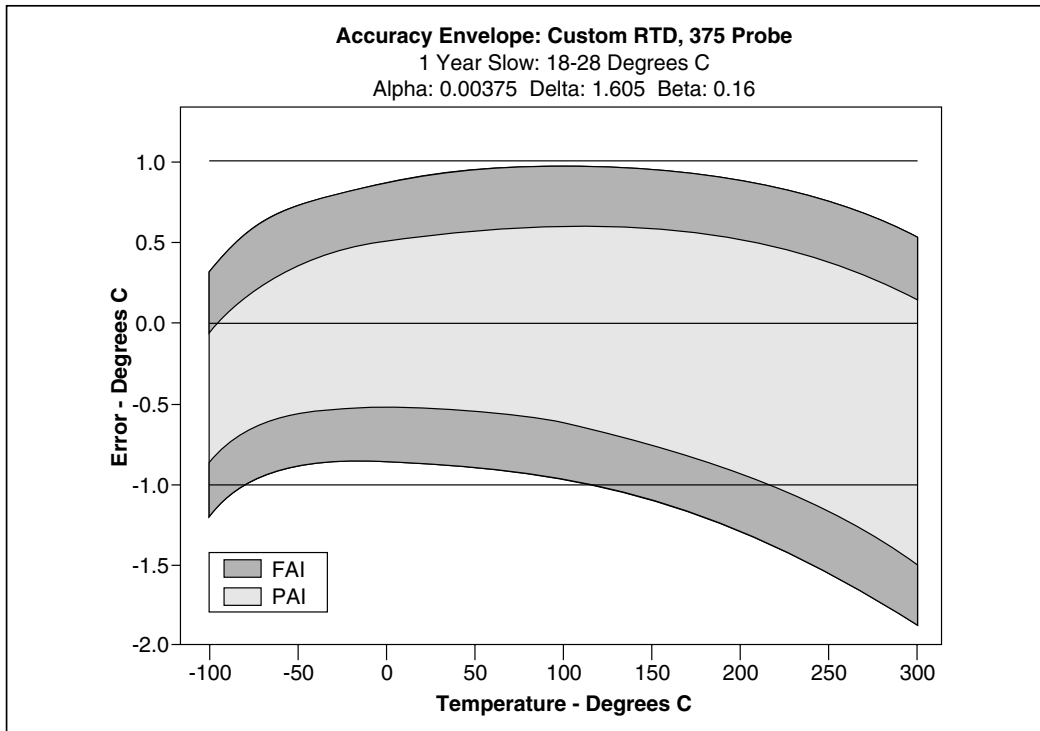
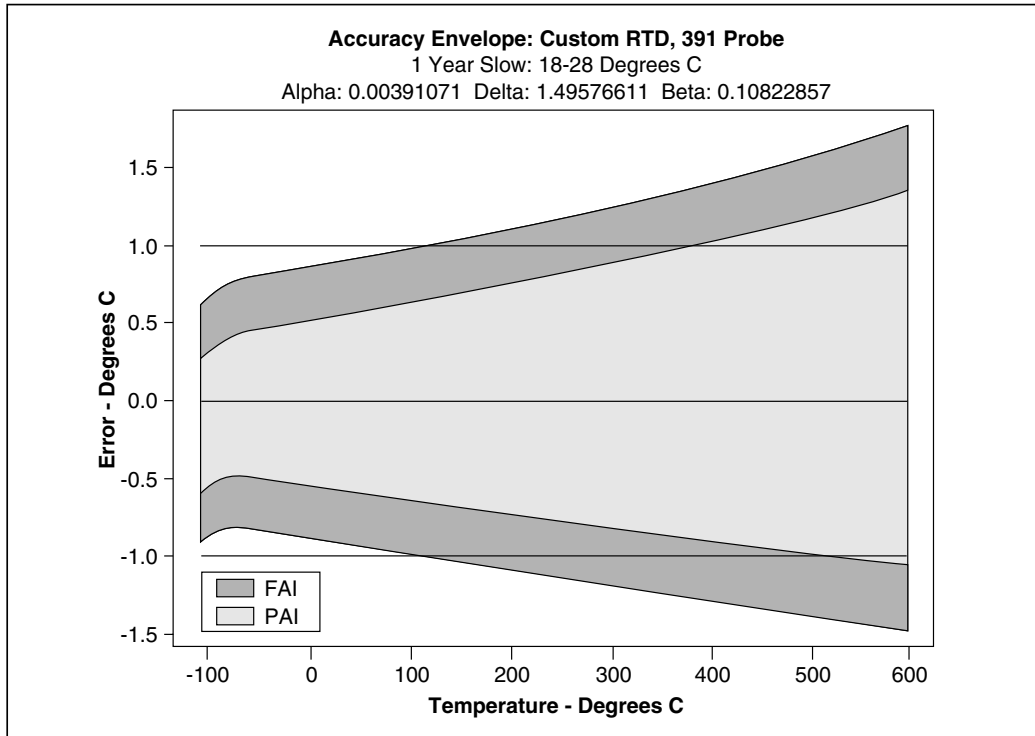

Figure D-2. 375 RTD

alg62f.eps



alg63f.eps

Figure D-3. 391 RTD

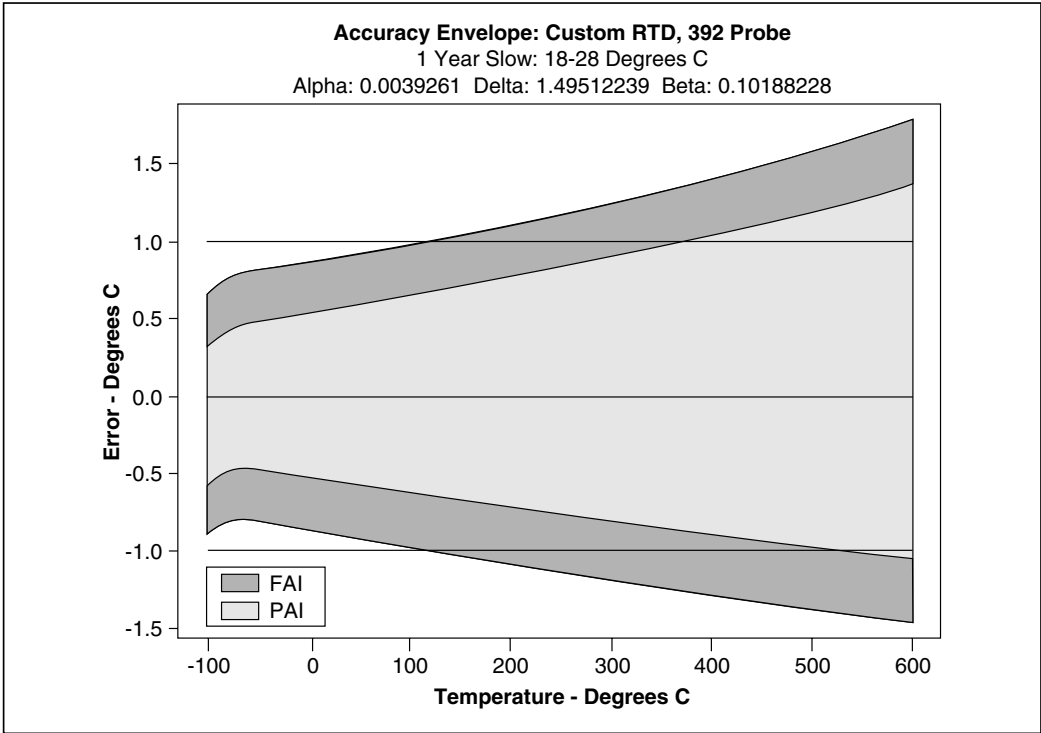

Figure D-4. 392 RTD

alg64f.eps

Appendix E

Computed Channel Equations

Introduction

An equation is converted into a stored binary format which is sent to the 2680 Series or NetDAQ instrument where the calculations are performed during the processing of each scan. Constants are passed to the instrument as single precision (4 byte) floating point numbers which have a maximum magnitude of 3.402823E38. Calculations and intermediate values in the instrument use double precision (8 bytes) in order to preserve resolution. The resulting computed channel value is a single precision floating point number. When the result is $>9999.9E+6$ or $<-9999.9E+6$, Fluke DAQ displays +OL or -OL for that channel, and changes the channel value to $+1.0E+9$ or $-1.0E+9$, according to the sign.

The instrument traps math errors such as divide by zero and log (0) and returns a non-numeric result which the Fluke DAQ reports as +OL. If a the value of a reference channel is non-numeric (indicating an open thermocouple or overload), the value $+1.0E+9$ will be returned for the computed channel.

Computed channel equations must observe the following syntax:

- White space is allowed, but not required, between symbols.
- White space and parentheses do contribute to the 250 character limit for the text string, but do not contribute to the size of the stored binary equation (all stored binary equations for a 2680 Series instrument cannot exceed 6000 bytes).
- Alphabetic characters may be in upper or lower case.

The symbols used in the syntax definition have the following meanings:

- $\langle \rangle$ enclose an element which needs further definition
- $\{ \}$ enclose elements that may be present zero or more times
- $[]$ enclose elements that may be present zero or one time

| separates alternative elements
 " " enclose literal characters or strings which must appear as shown (except for case)

() enclose groups of elements to clarify the scope of other symbols

<equation>	=	<add-term> { (“+” “-”) <add-term> }
<add-term>	=	<mul-term> { (“*” “/”) <mul-term> }
<mul-term>	=	<exp-term> { (“**”) <exp-term> }
<exp-term>	=	[(“+” “-”) <operand>]
<operand>	=	<channel> <alarm status> <constant> <function> (“<equation> “) “TOT” “TS”
<channel>	=	“C” <digit> <digit> <digit>
<alarm status>	=	“A” <digit> <digit> <digit>
<constant>	=	<mantissa> [<exponent>]
<mantissa>	=	({ <digit> } “.” <digit> { <digit> }) (<digit> { <digit> } [“.” { <digit> }])
<exponent>	=	“E” [“+” “-”] <digit> { <digit> }
<function>	=	<function-name> (“<equation> “)
<function-name>	=	“ABS” “EXP” “INT” “LN” “LOG” “SQR” “TOT” “TS”

Note

The NetDAQ 2640A and 2645A use one or two digit channel numbers. For example, the syntax is “C”<digit>[<digit>]. NetDAQ does not provide the alarm status (A###), totalizer (“TOT”), or the time of scan (“TS”) values for computed channel equations.

Appendix F

Data File Format

Introduction

The ASCII (CSV) data file is a text file in comma-separated ASCII format. The ASCII format is compatible with data analysis and management software and tools running on the same or other computers. CSV data files can be created by FlukeDAQ software in real-time, for example, while scanning, or after scanning, or after scanning has stopped with the Export function or with the PC Card Get Scans function on the 2686A.

File Format

The comma separated ASCII file format is as follows (<EOL> means “end of line”, a <CR><LF> sequence):

```
"File name string" <EOL>
>Date and time file was created" <EOL>
"File Comment" (< 70 character string) <EOL>
Number of Columns (including timestamp) <EOL>
Channel Number strings (comma separated GCN strings) <DOL>
Channel Units string (comma-separated strings) <EOL>
(Optional) Channel Label strings (if “Insert Labels” is selected) <EOL>
Scan Record 1 <EOL>
.
.
Scan Record n <EOL>
```

Data files from a single module or instrument contain channel readings from that source. Data files from a group of modules or instruments contain the time tag from the Master source and data from all sources in the group.

Each scan record consists of the scan time tag and a comma separated list of channel readings (including the DIO word, totalizer, alarm1 and alarm2). The time tag format is in Excel/Lotus Serial Number Date format, which is the number since midnight, January 1, 1900.

For example, 37890.12345679 - indicates September 26, 2003 04/29/94 2:57:46.667 (AM).

Strings in the data file are quoted to allow direct importation into Microsoft Excel and other data analysis and presentation packages.

Appendix G

Ethernet Cabling

Introduction

This appendix details the unshielded twisted-pair (UTP) cables used for 10/100BaseT Ethernet interconnection. UTP cable configurations are summarized in Figure G-1.

UTP Cables

There are two types of UTP cables: patch cord cables and direct connection cables.

Patch cord cables connect an instrument or host computer to an existing 10/100BaseT hub, usually via a network outlet. A patch cord cable has straight-through by pin-to-pin connections (see Figure G-1).

Direct connection cables are used to make a direct connection between an instrument and a host computer. A direct connection cable has the receive (RX) and transmit (TX) signal lines crossed. These cables are also known as crossover or cross-wired cables. This allows the RX line input to become a TX output, and vice versa (see Figure G-1). This signal reversal is a requirement when making a direct connection between an instrument and host computer. Be sure you use twisted-pairs for the RX and TX lines.

Note

Be sure to use CAT5 or better cable for a 100 Mbs network connection.

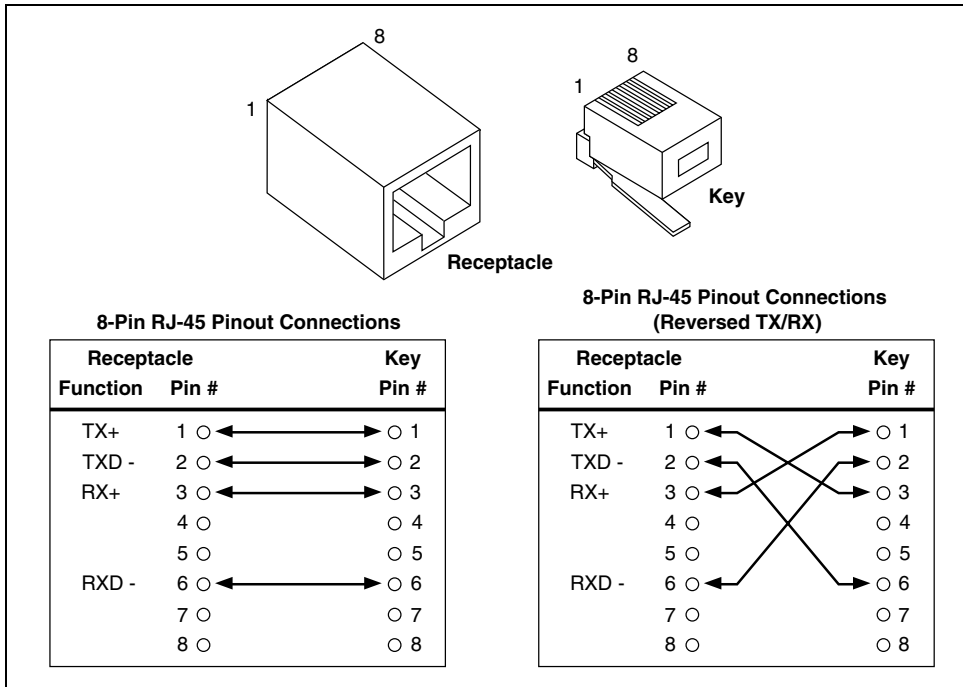

alg72f.eps

Figure G-1. 10/100BaseT Ethernet Cables

Appendix H

Network Considerations

Introduction

This tutorial provides information on commonly used Network communication technology and describe how to get started using the 2680 Series instruments. It's not necessary to know the details of Network communication methods in order to use 2680 Series instruments effectively.

The 2680 Series instrument and host computer software use Ethernet wiring and low level protocols, TCP/IP high level protocols, and the WINSOCK application interface layer. These are all public domain, non-proprietary standards with multiple-company support. Use of these non-proprietary protocols and hardware ensures that 2680 Series instruments and software will operate on most installed networks and have the lowest possible cost using off-the-shelf commercial networking products. Read Network Primer later in this Chapter for more information on these standards.

2680 Series and Your Network Administrator

If you plan to communicate between your host PC and the 2680 Series instruments on a network that is totally isolated from any other network communication devices, you can install the network and set up the instruments without consulting Network Administration. However, if you're going to communicate on an existing network, you need to coordinate this with your Network Administrator. Specifically, you need to ask the following questions before installing and setting up your instruments and host PC:

1. What values should I use for my IP addresses, and Subnet Mask? Does the Socket Port Number need to be changed from the default (4369)?
2. Does the network contain more than one subnet? If so, what's the IP address of my default gateway or router device?

3. Will all the routers route IP packets?
4. What are my domain and host names (optional)?

The minimum information you need to get is the IP Addresses for the PC and the instruments. If your network contains more than one subnet and you want to place the PC and one or more instruments in different subnets, you must also set the default gateway address and subnet mask on both the 2680 Series instrument and the PC.

The PC may use DHCP to get an IP address, subnet mask, and default gateway address automatically on the network.

Your Network Administrator may also need to know the Ethernet addresses of the PC Ethernet adapter and each 2680 Series instrument that you will attach to the network. Obtain the Ethernet address of the PC by running the hardware setup program supplied with the adapter hardware. Obtain the address of the 2680 Series instruments by using the front panel controls.

Read Network Primer for more information on IP addressing and the other information needed to operate 2680 Series on a general network.

Network Primer

In the early days of computer networking, vendors used many proprietary communication schemes. These forced users to purchase equipment and software from one or a few companies. As networking became more popular, users placed pressure on vendors to establish standards to allow interoperation of various types of computers, operating system software, and interface hardware.

One of these standardization efforts was started by the DARPA agency of the U.S. Defense department. Another was headed up by the DEC and Xerox companies. This effort resulted in the Ethernet wiring and low-level protocol scheme. The DARPA effort resulted in the TCP/IP high-level protocols. Ethernet became an international standard by the efforts of the IEEE-802.3 committee. TCP/IP is the protocol used on the international Internet Network and is supported by consensus of the users of that network (many thousands of hosts).

The Sockets API was developed at U.C. Berkeley and was widely adopted by the UNIX community to support direct Host-to-Host communication within a TCP/IP network. WINSOCK is an MS Windows Dynamic Link Library (DLL) version of the original UNIX Sockets library and has been standardized by a large number of PC Software and Hardware Vendors. WINSOCK has been included with Windows since the introduction of Windows 95 and Windows NT 4.0.

To reduce the complexity of network schemes and to encourage interoperation between varieties of networks, the protocols are built up of several layers that are isolated from each other by well-described interfaces. Usually, the lowest layers of the protocol are implemented in hardware logic on the interface circuits used by

the computers and other devices attached to the network wiring. The Ethernet standard consists of a set of low-level addressing and data transmission protocols that run on several different wiring schemes.

Computers on a network are usually referred to as a “host.” The 2680 Series instruments are hosts in this context. Instruments that facilitate communication between different sections of a network are called by names that indicate their function, for example, routers, bridges, repeaters, etc.

Physical Layer Wiring Schemes Supported by 2680 Series

The 2680 Series supports the most common wiring scheme used in Ethernet networks: 10/100BaseT (or UTP).

The 10/100BaseT wiring method uses two or four pairs of twisted wires. It is also referred to as Unshielded Twisted Pair (UTP) wiring. This wiring method supports only two connections to any one run of wire. To support more than two connections, an active instrument called a "hub" must be used.

A hub is an active device that supports multiple 10/100BaseT connections. The network host attached to each connection of the hub may communicate with every other host attached to the hub. Hubs also may allow other types of cable connections, such as 10Base2 and 10Base5 (fat coax). This is done to allow a hub to communicate with other network hosts, such as other hubs, routers, and bridges. A hub is sometimes referred to as a network switch.

If you want to use 10/100BaseT wiring without a hub (to connect one 2680 Series instrument and one PC), you must use a special 10/100BaseT cable. This is necessary because both hosts transmit and receive on the same pair of wires within the cable. To operate correctly in a direct wiring situation, these pairs must be crossed in the cable, so that the transmitter on one end is connected to the receiver on the other.

The 10/100BaseT wiring method is very popular because the wire is inexpensive to purchase and install, the use of a hub allows some protection from malfunctioning network hosts, and this type of wiring is easier for network administrators to manage and control.

Network Interconnection Devices

The following basic devices are used in networks to extend, partition, and interconnect networks:

- A repeater is a device used to physically isolate and extend the length of a network segment, but it does not divide the network into subnets.
- A hub is a device that allows communication among multiple 10/100BaseT network hosts and allows these hosts to communicate with other Ethernet wiring. Some hubs also perform Router functions.

- A *Bridge* is used on Ethernet networks to isolate two portions of the network at the Frame level (see Basic Network Packet and Frame Contents later in this appendix). This is done to minimize transmission collisions, but the two portions isolated by a Bridge remain on the same subnet. A Bridge also acts as a Repeater.
- A *Router* is used to isolate two portions of the network into subnets, as described in IP Addresses and Segmented Networks in this appendix. A Router also acts as a Bridge. Make sure your Router will route IP packets if you want to place the PC and 2680 Series instruments in different subnets.
- A *Gateway* is used to connect two networks with different architecture and protocols. For example, a Gateway could be used to connect an Ethernet to an X.25 net running on public telephone wiring. Gateways also perform Router, Bridge, and Repeater functions.

The operation of 2680 Series software and instruments should be unaffected by a properly designed network using any of these network devices. However, you must use extra care when setting up PCs and 2680 Series instruments in a network containing multiple subnets (net containing one or more routers and/or gateways). The IP addresses assigned to the PC and instruments must be carefully selected in this case. See IP Addresses and Segmented Networks for more information on IP address assignment.

When a Bridge, Router, or Gateway is used in a network containing 2680 Series instruments and hosts, be sure to reboot the host PC whenever an instrument is moved from one section of the net to another. This is required to allow the network hardware devices to initialize bridging and routing tables.

Also, when a 2680 Series instrument is used in a different subnet from the PC, the Routers and Gateways used to connect the subnets must be able to route IP packets. The default gateway addresses on the 2680 Series instrument and PC must be set properly as well.

Basic Network Packet and Frame Contents

Network messages consist of short (mostly less than 1 KB) hunks of data, surrounded by header and error detection information used by the protocols. The message, together with the protocol information, is called a "Packet." When physical network information (clock synchronization, error detection, etc.) is wrapped around the packet, it is called a "Frame." The interface hardware adds and strips off the Frame information around the packet. So, unless you're doing low-level analysis of network traffic, you never need to deal with Frame information.

For any protocol, the Packet consists of a destination address, a source address, some protocol type information, a message length field, and error detection information.

The TCP/IP protocol adds additional fields to the packet for message sequence determination and application port ID. The sequence number allows multi-packet messages to be assembled into the correct order. The port ID specifies which application running on a system is sending or receiving the message. Support of port IDs allow multi-tasking within a computer system, with messages being sent and received from the individual task.

In the TCP/IP protocol, error detection is supported by adding a checksum of the data in the packet to the end of each packet. Using this checksum, the receiving system can detect a bad packet and request a re-transmit (using the source address).

Each *Host* (device attached to the network wiring) in an Ethernet network has a unique address that is assigned by the interface hardware vendor. Each vendor is assigned a block of addresses and it is required that each device produced have a unique Ethernet address. Users of the TCP/IP protocol very rarely need to know or deal with the Ethernet address.

When TCP/IP is used, each host is also assigned a unique IP address, but this address is assigned by the user when the TCP/IP protocol software is initialized. In contrast to the Ethernet address, IP addresses have a structure that can be used by Network Management to facilitate breaking the network into segments (subnets) that make better use of the available data communication capacity (bandwidth). Use of IP addressing and the network segmentation scheme is described in IP Addresses and Segmented Networks in this appendix.

The relationship between a host's Ethernet address and its IP address is established by the TCP/IP protocol software. No user interaction is needed to establish this relationship. However, some network management systems require that the Ethernet address of each network host be kept in a data base. So, it is sometimes necessary to communicate the Ethernet addresses of all devices on the network to the Network Administrator.

IP Addresses and Segmented Networks

If all networks consisted of a few computers and other devices attached to each other locally, use of IP addressing and network segmentation schemes would not be necessary. However, networks have evolved past simple work groups into campus-wide, inter-campus, and even international interconnect schemes. This makes it necessary to divide the network into subnets.

The IP address provides two pieces of information: the *network ID* and the *host ID*. The network ID must be unique among all network subnets within a connected Internet. It identifies the network subnet to which a host is connected. The host ID must be unique among hosts within a network subnet and identifies the host within the subnet.

Network subnets connected to the public Internet must obtain an official network ID from a registrar approved by the *Internet Network Information Center* (<http://www.internic.net/>) to preserve the unique network ID's within the Internet. However, if you never intend to connect to the Internet, you're free to select your own network IDs.

The IP address consists of four numbers. Each of these four numbers can have a value in the range 1 to 254. An IP address is written in the form w.x.y.z. For example, "198.178.246.10" (or "C6.B2.F6.0A" in hexadecimal) is a valid IP address.

There are three commonly used classes of IP address assignment as follows:

Class	w Value	Net ID	Host ID	Available Subnets	Available Hosts
A	1 to 126	w	x, y, z	126	16777214
B	128 to 191	w, x	y, z	16384	65534
C	192 to 223	w, x, y	z	2097151	254

The following are reserved addresses and may not be assigned to hosts:

127.0.0.0

128.0.0.0

191.255.0.0

192.0.0.0

223.255.255.0

w = 224 through 255 with x, y, and z equal to any value

Most IP subnets have Class B or C Net IDs because there are quite a few of these available. You may be able to get a Class A Net ID, but there are so few of these available (only 126 world-wide) that they are rarely issued and most are already assigned.

Most companies get one or more Class C assignments, which means that there is a limit of 254 hosts per network subnet.

The TCP/IP software separates the Net ID portion of the IP address from the Host ID portion using the user-assigned Subnet Mask. This mask looks like an IP address, but has a bit set in each bit position of the portion of the IP address that is in the Net ID portion. For example, the Subnet Mask 255.255.255.0 sets the Net ID portion to be the higher order 24 bits of the IP address (a class C address). Using the Subnet Mask, the TCP/IP software is able to detect if a destination address is in the local subnet or if the packet must be sent to another subnet through a Router or Gateway.

Networks are segmented by use of an active device called a *Router* (*Gateways* and *hubs* sometimes have router capabilities.) When a host on one subnet wants to send a message to a host on another subnet (the Net ID sections of the IP source and destination are different), the Router is used to deliver the packet to the other network subnet.

2680 Series instruments are shipped with a default IP address of 198.178.246.*bcn*, where *bcn* is the base channel number assigned to the instrument. This is a Class C Net ID assigned to the Fluke Corporation, so it is highly unlikely that it will overlap with a Net ID in use at your company. However, if you want to attach a 2680 Series instrument to an existing network, you should check with your Network Administrator before using the default IP address or assigning a new IP address to a 2680 Series instrument or PC.

When assigning the IP address to your PC, unless your network contains a Router, you must use the same Net ID used by the 2680 Series instruments (for example, 198.178.246.*z*). If you do this, you should set *z* to a number that does not interfere with the instruments. Because the BCN can range from 1-99, you should set *z* of the IP address of your PC in the range 101-254. The Subnet Mask assigned to the PC should be 255.255.255.0.

If your network contains more than one subnet, and you want to communicate with a 2680 Series instrument in another subnet, you need to set the default gateway address in both the PC and 2680 Series to the address of the local router. The TCI/IP stack will detect that the destination address for a packet is in a different subnet (via the subnet mask) and send the packet to the default gateway address where the router will route it to the proper subnet.

For example, if you have three 2680 Series instruments with *bcn*'s 1, 2, and 3, and a single PC, you could set the following IP addresses:

2680 Series #1	198.178.246.1
2680 Series #2	198.178.246.2
2680 Series #3	198.178.246.3
Host PC	198.178.246.101

This would place all three instruments and the PC in the same subnet (net ID 198.178.246).

During initial operation of the TCP/IP software the IP section builds a table that contains the correspondence between the IP address and Ethernet address of each host. This is done via the Address Resolution Protocol (ARP). To do this, the IP software sends out a broadcast frame that every TCP/IP host and router receives. This frame contains a request for the host with the unknown IP address to return a frame to the ARP requester. This response frame contains the Ethernet address of the sourcing host, and this information is then added to the address correspondence table. All communication with a host can then be done with information from the table.

The operation of ARP also initializes the routing tables in bridges, routers, and gateway devices on the net. These tables are used to determine the section of the network to which a frame should be sent.

Ethernet Adapter Hardware for the PC

To communicate via the Ethernet network, each PC must be equipped with an Ethernet adapter. There are several types of adapters available (e. g. internal interface boards (ISA or PCI), PCMCIA interface cards, and USB adapters). Some PCs are equipped with an Ethernet adapter by the manufacturer, but often adapters must be added after purchase.

Installation of an Ethernet adapter is quite simple. Windows NT, and later versions of Windows can install commonly used adapters without using the adapter's installation software.

During the installation of an internal interface board on an ISA bus computer, you may need to make several detailed configuration decisions. An interrupt line (IRQ) is assigned, port addresses selected, and the network connection type selected. Be sure to record these configuration values because you might need them when installing the network interface software. Installation of a PCI interface board is similar, but is usually more automatic.

During installation of a PC Card or USB interface, few, if any decisions need to be made. These devices make use of already established interfaces to the computer bus.

Drivers

A driver is the low-level software within the PC that communicates directly with the interface adapter hardware. Drivers cover up the specific nature of the hardware interface and allow the protocol software to be unaware of the type of hardware being used.

Drivers are usually written and supplied by the adapter vendor. Windows 95, Windows NT, and later versions of Windows supply drivers for commonly used adapters. Windows built-in networking typically uses NDIS or ODI drivers. Some

third-party networking software may use packet drivers. For information on packet drivers, contact the networking software supplier.

Both ODI and NDIS are multi-protocol, packet driver standards. They both allow operation of more than one set of protocol software "over" the driver at the same time. Use of this feature will be discussed in the protocol section below.

The ODI standard was defined by Novell for use with the NetWare line of networking software. It supports the native IPX/SPX protocol of NetWare and other protocols, such as TCP/IP.

NDIS was defined by 3COM and Microsoft for use with the LAN Manager networking software. It has since become commonly used by other network operating systems, including the Windows built-in networking software. It also supports multiple protocols, including IPX/SPX and TCP/IP.

ODI and NDIS drivers are usually loaded automatically by Windows, but may be included in a `DEVICE=` line in the `config.sys` file.

The built-in Windows networking driver is controlled by the Network applet in the Control Panel. With other networking software, the setup information for NDIS drivers is contained in a file called `protocol.ini` that must be in the same directory from which the driver is loaded. This file contains sections describing the driver characteristics and the protocols that may be operating over the driver. For example, a driver characteristic section might look like this:

```
[EtherLinkII]
DRIVERNAME=ELNKII$
INTERRUPT=5
TRANCEIVER=INTERNAL
IOADDRESS=0x300
```

While a protocol section might look like the following:

```
[NETMANAGE]
DRIVERNAME=NETMNG$
BINDINGS=EtherLinkII
```

These two `protocol.ini` file sections describe a hardware driver characteristic for a 3COM EtherLink II hardware card and specifies that the Net Manager protocol stack should bind with the EtherLink II driver.

The setup information for ODI drivers is contained in a file called `net.cfg` that must be in the Novell directory (the driver must be there too). This file contains sections describing the driver characteristics and the protocols that may be operating over the driver. For example, a driver characteristic section might look like the following:

Link Support

```
Buffers 8 1589
MemPool 4096
```

```
Protocol IPX
    Bind EXP16ODI
Protocol
    Bind EXP16ODI
    ip_address 198.178.246.101
Link Driver EXP16ODI
    Port 300
    Frame Ethernet_802.3
    Frame Ethernet_II
    Protocol IPX Ethernet_802.3
```

This net .cfg file describes a hardware driver characteristic for an Intel EtherExpress 16C hardware card and specifies that the IPX and TCP/IP protocol stacks should bind with the EtherExpress driver.

TCP/IP Protocol Stack

A protocol stack is a group of interacting programs that implement the various functions of the network communication protocol. They are usually arranged in a hierarchy of low to higher level functions, so the collection is called a *stack*.

Windows 95, Windows NT, and later versions of Windows supply a TCP/IP protocol stack. Novell sells an optional package for NetWare that includes a TCP/IP stack. TCP/IP protocol packages with included WINSOCK DLLs can also be purchased from a variety of third-party sources.

The *Transmission Control Protocol/Internet Protocol* (TCP/IP) has evolved as a networking protocol that supports communication among diverse computers and devices (at U.C. Berkeley there once was a TCP/IP-connected Coke machine). The TCP/IP protocol can be used to communicate between programs running on many different computer systems, running under many different operating systems, and even running on several different physical network types (Ethernet being only one of the many types supported).

The TCP/IP protocol stack is isolated from the underlying network hardware by a device driver. Applications use TCP/IP resources via one of the several Application Programming Interfaces (API) that are commonly supported by network software vendors. The API used by the 2680 Series software is WINSOCK. There are also API's for file transfer (FTP) and file sharing (NFS and others).

You rarely need to know the details of the TCP/IP protocol. In summary, TCP/IP enables two computer systems to establish a connection that allows data to be exchanged. Data to be transmitted is broken up into manageable chunks (packets) by the TCP portion of TCP/IP. TCP also reconstructs the data at the receiving end

by merging the chunks back together in the correct order. TCP also assures error-free communication by use of a checksum within each packet. Finally, TCP uses the Port ID to specify the specific application within each system that is sending and receiving the data.

The IP portion of the TCP/IP protocol simply addresses, sends, and receives packets. It uses the IP address, the Subnet Mask, and the Default Gateway information. The IP address is described in IP Addresses and Segmented Networks in this appendix.

The subnet mask is used to separate the network ID from the host ID in an IP address. For example: if the IP address of a 2680 Series address was 198.178.246.10, and a class C network ID was active, the subnet mask would be 255.255.255.0. When this mask is applied to the address, the network ID is extracted as 198.178.246 and the host ID as 10.

The default gateway information is only used when your network contains more than one subnet, or is connected directly to the Internet. When the network ID of the source and destination address of a packet are different (hosts on different network segments), the packet is forwarded to the default gateway for delivery. The default gateway has knowledge of the network IDs of the other network segments, so it forwards the packet to other gateways on the network until the packet is delivered to the gateway attached to the destination segment with the matching network ID. This process is generally referred to as *routing the packet*, and devices that do this are also referred to as *Routers* or *Gateways*.

In many modern networks, the use of subnet masking and the default gateway is not necessary. These networks contain routers and gateways that support the Proxy ARP protocol. In this protocol, the routing path between any two hosts is automatically established by the routers during the ARP process. As a result, the user doesn't need to manually enter the subnet mask and default gateway information.

When the TCP/IP protocol stack software starts operation, it communicates with an NDIS or ODI driver in a process called *Binding*. During this process, the stack tells the driver which protocol it is handling. In this way, a driver can direct packets to more than one protocol stack. For example, it is quite common to have the Novell IPX/SPX protocol stack and the TCP/IP protocol stack operating over the same ODI multi-protocol driver.

WINSOCK DLL and Application Programming Interface

The Fluke DAQ software uses the TCP/IP protocol via a set of resources contained in a `winsock.dll` (`WINSOCK32.DLL` for 32-bit operation). This DLL contains a set of functions that support two-way communication between two hosts on the network. Of course, both hosts must support the TCP/IP protocol for a WINSOCK connection to be successful.

WINSOCK isolates the 2680 Series software from the specific implementation of TCP/IP operating in the PC. WINSOCK's interface to applications has been standardized by a committee of many different PC hardware and software vendors. This makes it possible to operate 2680 Series software over WINSOCK's from different software vendors.

Windows 95, Windows NT, and later versions of Windows provide a WINSOCK as part of the TCP/IP protocol.

Notes to Network Administrators

The 2680 Series product line consists of the 2680A (Data Acquisition System) and the 2686A (Data Logging System) instruments, the PC software, and some options. The instruments communicate with the PC using the TCP/IP protocol and the Ethernet physical network. Using proper Gateway devices, the PC could be on almost any physical network that is capable of carrying or tunneling TCP/IP packets and can gate to an Ethernet.

2680 Series devices use fixed IP addresses. They support user entry of the subnet mask and the default gateway. On networks that contain routers and gateways and support the Proxy ARP protocol or have static routing tables, you don't have to use these parameters. In the Proxy ARP protocol, the routing path between any two hosts is automatically established by the routers during the ARP process.

The 2680 Series PC software communicates with the 2680 Series instruments in a totally peer-to-peer manner. Operation of the instruments and software require no server support. As a result, as long as your network can carry and route TCP/IP packets, you should have no interaction between communication with the 2680 Series instruments and other traffic on the network.

The PC software runs in the 32-bit Windows environment and is designed to operate over any `winsock.dll` that supports version 1.1 of the WINSOCK standard. If your PCs already has a `winsock.dll` and TCP/IP stack loaded, you should use that. In Novell environments, you may want to use the LAN Workplace product from Novell.

Whichever `winsock.dll` that you use, make sure that there's only one file with this name in any directory specified in your PATH. WINSOCK libraries are specifically matched to the underlying TCP/IP software and are not

interchangeable between software vendors. If the wrong `winsoc.dll` is found during startup, it will be loaded and the network interface will not operate.

The 2680 Series instruments have a unshielded twisted pair (10/100BaseT) connector for network connection. It automatically selects 100 Mbs or 10 Mbs to match the speed of the network port to which it is connected.

If you are already using the TCP/IP protocol for client/server activities on your network, you may want to review the socket port assignment for the 2680 Series instruments and PC software. If you already have a service assigned to the socket port that is used as the default in the 2680 Series products, you may have to change the port used by 2680 Series. The list of supported services is usually in the “SERVICES” file in the directory that contains the TCP/IP stack software.

Again, if you are already using TCP/IP, you must assign IP addresses to the instruments (and PCs of course) in accordance with your established subnet scheme. If you install the Fluke DAQ software for “general network” operation, you are free to select any IP address for the PC and instruments. With the isolated network operation, you are limited to using the 198.178.246.0 subnet (Class C subnet assigned to the Fluke Corporation) for both the PC and instruments.

If your network contains routers, bridges, gateways, or other devices that divide the network into subnets, and you intend to have the PC on a different subnet from the 2680 Series instrument(s), you need to make sure that the instruments can route IP packets. This is especially true on Novell networks, where the network may contain devices that can route only IPX packets.

The PC software uses the Address Resolution Protocol (ARP) to establish the relationship between the physical address and IP address of the 2680 Series instruments. The ARP protocol uses broadcast messages. So, your routers must be set up to pass ARP broadcasts to all subnets containing 2680 Series instruments.

Running Two Network Cards in a PC

There are cases when you may want to operate more than one network interface on your PC. You can do this if you're careful in setting up the adapters and configuring the software.

One instance when you might want to use two adapters in your PC is when you want to communicate with the 2680 Series instruments on a network that is separate from your general, multipurpose network. Another is when your general network uses other than Ethernet hardware (such as Token Ring).

Use of two network adapters will allow higher throughput when communicating at high speed with a set of 2680 Series instruments on one network and logging data to a file server over the other network.

When setting up two network adapters in a single PC, make sure that the hardware resource setups do not overlap. For example, each ISA interface adapter needs a

unique interrupt level (IRQ) and port address. This is sometimes hard to do because of the limited number of IRQ levels available in the PC hardware, so be careful.

If you're using two ISA bus Ethernet adapter cards, make sure that the IRQ level and port addresses don't overlap. Also make sure that you add the I/O address to the end of the packet driver load line, in the driver section of the `protocol.ini` file for the NDIS driver, or in the driver section of the `net.cfg` file for the ODI driver.

Troubleshooting Information

This section presents some information about what to do if you cannot successfully communicate between your PC and 2680 Series instruments.

1. Bind fails during PC boot.

Check that the information in the driver section of the `protocol.ini` file associated with the NDIS driver, matches the setup of the Ethernet adapter.

Check for misspelled words in the `protocol.ini` file (NDIS driver). Make sure that the `BINDINGS=` line in the `[NETMANAGE]` section contains the name of the correct driver section.

Check that the soft interrupt specified for use by the network interface driver is the same as specified for use by the protocol software. Make sure that this interrupt is not being used by another software package (i.e. another hardware driver).

2. Network software loads and binds properly, but Fluke DAQ cannot communicate with the instrument.

Use the communication configuration dialog and the instrument front panel interface to check that the Base Channel Number (BCN), IP address, Socket Port Number, and Instrument Type are all correct for each instrument.

If General Networking mode is selected, check that the subnet of the PC is the same as the subnet of each instrument (see IP Addresses and Segmented Networks in this appendix). If the subnets are not the same, check the router connecting the subnets to make sure it can route IP packets. Also check the 2680 Series instrument and the PC default gateway addresses to make sure they are set correctly.

Make sure that the link indicator (LED on the rear panel) is lit continuously. If it is not, make sure that connection to the hub is correct and that the hub port is active. The link indicator on the 2680 Series instruments is red for 10 Mbs and green for 100 Mbs operation.

If you have replaced an instrument with another with the same IP address (same BCN in the isolated network mode), you must reboot your PC. The TCP/IP software builds a table of the relationship between an instrument IP address and its Ethernet address. If you attach a new device to the network with an IP address that has been previously used, the relationship between the IP and Ethernet address will be wrong, causing communication with that instrument to fail. Rebooting the PC clears the IP/Ethernet address relationship table (the ARP table).

Make sure that there is only one TCP/IP stack software package running on this PC.

3. Instrument to PC communication starts OK, but there are frequent communication interruptions reported.

There may be times on a very heavily loaded general network where it is impossible to maintain high enough speed communication with the instrument to avoid communication interruptions. In this case, consider moving the instrument to an isolated network or a different subnet.

4. Fluke DAQ can not keep up with the scan rate selected in the instruments. This is indicated by the count of the number of scans in the instrument increasing continually, to the maximum count, during a data acquisition run. Once the maximum count is reached scan data may be lost.

Move your instrument to a less loaded subnet of your network or isolate the 2680 Series instruments on their own network.

If possible, increase the scan interval.

Make sure that there are few or no other Windows applications running at the same time as Fluke DAQ.

Upgrade to a faster PC and disk drive and increase the amount of RAM in your PC.

Disable the Windows Screen Saver function or make sure that it doesn't activate during data collection.

Close any dialog boxes that you have open in Fluke DAQ. Avoid operations which open dialog boxes, such as configuring an instrument, while logging data at high speed.

Use of disk caching utilities increases throughput to the data files. However, data could be lost if the PC crashed suddenly due to power failure or malfunction.

Make sure the disk drive that you're writing the data files to is not fragmented. Disk fragmentation develops during a long period of writing and deleting files on the disk. Use a defragmentation utility to reduce this problem.

If you're using a general network that is loaded by other communication, isolate your instruments and host computer onto separate wiring and a separate host computer interface adapter from general network communication. If you must still communicate via the general network, consider installing two network adapters in your host computer and communicate only with 2680 Series instruments on one adapter and wiring.

6. Interaction with advanced display adapter driver packages.

A very common software interaction exists between network support software and advanced display adapter driver and support packages. If your network software doesn't load or operate properly, try selecting the standard display driver in Windows Setup under the control panel. If the problems go away, contact your display adapter vendor for the latest version of their display adapter driver and associated support software. If using the latest version doesn't fix the problems, you may have to use a less capable display adapter driver package when running the 2680 Series and other networking software.

Handling Token Ring Networks

If you need to install your 2680 Series instrument on an existing token ring network, your network must contain a Gateway device (see Network Interconnection Devices in this appendix). The Gateway must support both Ethernet and Token Ring subnets, and must be capable of routing IP packets between these two subnets. You will need to consult with your Network Administrator about setting up the routing tables in the Ethernet to Token Ring Gateway device to allow proper routing of IP packets.

Appendix I

Error Codes

Introduction

This appendix describes error codes that may appear in the user software.

Error Codes

Table I-1. Error Codes

Error Code	Explanation
-1	Invalid request number
-2	Invalid parameter or number of parameters
-3	Instrument is busy
-4	Command cannot be executed while scanning is enabled
-5	Command cannot be executed while scanning is disabled.
-6	Command cannot be executed because no channels are configured
-7	Command cannot be executed because the specified channel is not configured
-8	No input module in the specified slot
-9	Non-volatile storage is corrupted
-10	No spy measurements are available
-11	Enable scanning time is >24 hours in the future
-12	No reference junction measurement is available

Table I-1 Error Codes (cont.)

Error Code	Explanation
-13	Serial pass thru state already enabled
-14	Serial pass thru state disabled
-15	Serial pass thru receive error
-16	Serial pass thru state is busy
-17	Configuration mismatch prevented scan data from being appended to existing data already on care
-18	No output module is installed
-19	PC card is full
-20	No PC card is inserted or available
-21	Could not read/write to PC card
-22	Can't get more than 5000 scans at a time from the PC card
-1001	Error opening network configuration file
-1002	Configuration file has different fields
-1003	No BCN number defined
-1004	Calling an incorrect version of communication layer
-1005	WINSOCK.DLL has already unloaded
-1006	Cannot open socket
-1007	Null pointer to data to be sent
-1008	Stream buffer full
-1009	The command sent cannot be verified
-1010	Packet header checksum error
-1011	WINSOCK.DLL not found
-1012	Socket read error
-1013	Socket send error
-1014	Connection is down
-1015	Timeout has occurred
-1016	Invalid socket parameter
-1017	General WINSOCK related error
-1018	WINSOCK.DLL already loaded

Table I-1 Error Codes (cont.)

Error Code	Explanation
-1019	WINSOCK.DLL found, but could not be initialized
-2001	During initialization, Toolbox already initialized
-2002	Toolbox not yet initialized
-2003	BCN is not in a valid range (1-99)
-2004	Bad internal Window Toolbox timeout
-2005	Communications already opened for this BCN
-2006	Channel number out of range
-2007	Communications not open to the instrument
-2008	Trying to create a configuration for a BCN that already has a configuration
-2009	Tried to create more than the maximum number of configurations
-2010	BCN not registered in the CCF
-2011	Out of memory error returned from Toolbox
-2012	CCF doesn't exist or cannot be read
-2013	Cannot create or write the CCF
-2014	BCN cannot be found in the CCF
-2015	Illegal TCP/IP port number
-2016	Invalid model number
-2017	Invalid path provided for loading CCF file
-2018	CCF file damaged or corrupted
-2019	Attempted to set an invalid Network mode
-2020	Network is in General mode and there is no IP address entered for the instrument
-2021	Model of instrument and model of instrument stored in CCF do not match
-2022	Requested more than the maximum number of scans
-2023	Bad system time on PC
-2024	The model/version inquiry returned an unknown model number
-2025	Configuration is invalid

Table I-1 Error Codes (cont.)

Error Code	Explanation
-2026	Not all communication ports are closed
-2027	Timeout occurred during network operation
-2028	Error returned from instrument. Either someone is using the instrument or the wrong TCP port number is being used in General Network mode.
-2029	Toolbox function is being called while another Toolbox function is processing
-2030	Bad baud rate given when enabling Pass Thru mode on the secondary interface port
-2031	Buffer size exceeds the maximum buffer limit
-2032	Bad parameter value sent to flxConfixSet() or Get()
-2033	Bad model for this function
-2034	Bad PC card file

Index

—1—

10/100BaseT (twisted-pair) Ethernet wiring ,
interconnection, 2-50

—2—

2-Wire resistance accuracy test
FAI module, 4-22
PAI module, 4-21

—4—

4-Wire resistance accuracy test
FAI module, 4-28
PAI module, 4-24

—A—

AC fuse, 4-7
AC power, operating using, 2-6
Accessories, options and, 1-18
Accuracy performance tests, 4-13
Alarm
 master, 1-9, 2-10
 trigger, 1-10
Alarm dialog, 3-12
Alarm/trigger I/O connections, 2-8
Alarms, 1-9
Analog channel, 1-11
Analog channel integrity test, 4-20
Asynchronous device operations, 1-14

—B—

Base channel number, reviewing and
setting, 2-31
Basic network packet and frame
contents, H-4
Block Diagrams, A-30

—C—

Calibration, 4-35
Capabilities, device, 1-5
Channel
 computed, 1-11
 monitoring, 1-10
 monitoring, analog, 1-11
 numbering, 1-10
Channel, analog, 1-11
Cleaning, 4-6
Common mode voltage, 2-7
Communications
 RS-232, 1-17
Computed channel, 1-11
Computed channels
 defining an equation, E-1
Configuration dialogs, 3-11
Configuration dialogs, 3-9
Configuration, power-on, 2-24
Configuring the performance test setup, 4-9
Connecting to a power source and device
 grounding, 2-5
Connections
 alarm/trigger I/O, 2-8

- digital I/O module, 2-15
- universal input module, 2-12
- Controls
 - front panel, 2-17
 - rear panel, 2-22
- Controls and indicators, 2-17
- Crosstalk considerations, 2-15, B-2
- Custom-385 RTD, D-2

—D—

- Data file format, F-1
- DC fuse, 4-9
- DC power, operating using, 2-7
- Device
 - unpacking and inspecting, 2-5
- Device and host computer
 - interconnection, 2-49
- Device features and capabilities, 1-5
- Device grounding, 2-5
- Diagnostics, 4-3
- Digital I/O, 1-12, 2-16
- Digital I/O connector module, 2-15
- Digital input/output tests, 4-29
- DIO relay/fuse tests, 4-30
- Display
 - variations in the, 4-35
- Displaying
 - digital I/O status, 2-27
 - monitor channel, 2-25
 - totalizer status, 2-30
- Driver
 - packet, H-9
- Drivers, H-8

—E—

- Effects of internal noise in ac
 - measurements, C-1
- Error codes, 4-3
- Ethernet adapter installation, 2-47
- Ethernet address, viewing, 2-44
- Ethernet cabling, 2-49, G-1
- Ethernet port selection, 1-14
- External trigger, 1-9
- External trigger wiring, group device, 2-10

—F—

- Features, device, 1-5
- File format, F-1
- Fixed-385 RTD, D-1
- Fluke DAQ
 - Alarm dialog, 3-12
 - checking operational status, 3-8
 - Communication dialogs, 3-11
 - Configuration dialogs, 3-9
 - configuring a computed channel, 3-24
 - inserting a device, 3-13
 - inserting and configuring a channel, 3-22
 - inserting and configuring a module, 3-18
 - installing, 3-3
 - Mail and Web Settings dialogs, 3-12
 - Managing Your Network, 3-13
 - Security dialogs, 3-11
 - security features, 3-41
 - starting a configuration scan, 3-30
 - starting a device scan, 3-31
 - starting scan using Spy, 3-32
 - subdirectories, 3-4
 - toolbar, 3-5
 - Trend dialog, 3-12
 - using equations with computed
 - channels, 3-28
 - viewing alarms, 3-39
 - viewing collected data, 3-35
 - viewing module measurement data, 3-33
 - web and alarm mail settings, 3-42
 - workspace area, 3-7
- Fluke, contacting, 1-3
- Frequency accuracy test, 4-19
- Front panel controls, 2-17
- Front panel indicators, 2-19
- Fuse replacement
 - AC fuse, 4-7
 - DC fuse, 4-9

—G—

- General network IP address, reviewing and
 - setting, 2-41
- General network operation, 1-14

General network socket port, reviewing and setting, 2-40
Grounding and common mode voltage, 2-7
Group device operations, 1-15
Group device, external trigger wiring for, 2-10

—H—

Host computer Ethernet adapter installation, 2-47
Host computer networking parameters, setting, 2-53
Host computer networking software, installing, 2-52
Host computer requirements, 1-17

—I—

I/O, Digital, 1-12
Indicators
 front panel, 2-19
 rear panel, 2-23
Initializing the performance test setup, 4-11
Input, trigger, 1-8
Installation
 Ethernet adapter, 2-47
 host computer Ethernet adapter, 2-47
 host computer networking software, 2-52
 testing, 2-54
Installing Fluke DAQ software, 3-3
Interconnection
 device and host computer, 2-49
Interconnection using 10/100BaseT (twisted-pair) Ethernet wiring, 2-50
interface, PC Card, 1-8, 2-46
Interval trigger, 1-9
IP address for default gateway, 2-42
IP address for device, setting, 2-42
IP address for host computer, setting, 2-53
IP addresses and segmented networks, H-5
Isolated network operation, 1-14
Isolated network type, reviewing and setting, 2-35

—L—

Line frequency, reviewing and setting, 2-33
Linearization, RTD, D-1

—M—

Mail and Web Settings dialogs, 3-12
Maintenance, 4-3
Master alarm, 1-9, 2-10
Master alarm output tests, 4-14
Monitoring
 channel, 1-11, 2-25
 digital I/O status, 2-27
 totalizer status, 2-30
Mx + B Scaling, 1-11

—N—

Network Administrator, H-1
Network administrators, notes to, H-12
Network cards, two in one PC, H-13
Network considerations, H-1
Network interconnection devices, H-3
Network interface hardware (PC), H-8
Network primer, H-2
Network problems, troubleshooting, 2-58
Noise and shielding, B-2
Noise considerations, B-1
Numbering, channel, 1-10

—O—

Open thermocouple response test, 4-20
Operation, preparing for, 2-3
Options and accessories, 1-18
Options, power-on, 2-24
Output, relay, 1-12
Output, trigger, 1-8

—P—

PC Card options, reviewing and setting, 2-46
PC Card Options, setting, 2-46
Performance test, 4-9
Physical layer wiring schemes, H-3
Positioning and rack mounting, 2-5
Power

- AC connection, 2-6
- DC connection, 2-7
- Power source, connecting to and device grounding, 2-5
- Power-on options, 2-24
- Preparing for operation, 2-3

—R—

- Rack mounting, 2-5
- Rear panel controls, 2-22
- Rear panel indicators, 2-23
- Relay output, 1-12
- Relays, 2-17
- Replacement parts, 4-36
- RS-232 Commands
 - *RST, J-2
 - *TST, J-2
 - CAL_DATE?, J-3
 - command summary, J-1
 - DIO, J-3
 - DIO?, J-3
 - MAOUT, J-4
 - RELAY, J-4
 - RELAY?, J-4
 - SELFTEST?, J-5
 - SERIAL?, J-5
 - TOT?, J-5
 - TOTCFG, J-5
 - TOTCFG?, J-6
 - TOTINIT, J-6
 - TRIN?, J-6
 - TROUT, J-6
- RS-232, interface, 1-17
- RTD
 - custom-385, D-2
 - fixed-385, D-1
 - using custom-385 with other platinum RTDs, D-3
- RTD linearization, D-1

—S—

- Scaling, $Mx + B$, 1-11
- Security dialogs, 3-11
- Security, Fluke DAQ, 3-41

- Segmented networks, IP addresses and, H-5
- Self-test diagnostic, 4-3
- Service, 4-36
- Setting host computer networking parameters, 2-53
- Shielded wiring, 2-15
- Shielding considerations, B-1
- Specifications
 - 2680A/2686A, general, A-2
 - communication I/O, A-5
 - digital input/output, A-28
 - digital relay, A-29
 - FAI A/D 2-wire resistance measurement, A-23
 - FAI A/D 4-wire resistance measurement, A-22
 - FAI A/D 4-wire RTD measurement, A-23
 - FAI A/D AC voltage measurement, A-20
 - FAI A/D DC voltage measurement, A-18
 - FAI A/D frequency measurement, A-27
 - FAI A/D thermocouple measurement, A-24
 - master alarm output, A-5
 - PAI A/D 2-wire resistance measurement, A-12
 - PAI A/D 2-wire RTD measurement, A-13
 - PAI A/D 4-wire resistance measurement, A-11
 - PAI A/D 4-wire RTD measurement, A-13
 - PAI A/D AC voltage measurement, A-8
 - PAI A/D DC voltage measurement, 1-6
 - PAI A/D frequency measurement, A-17
 - PAI A/D thermocouple measurement, A-14
 - PC Card storage capacity, A-5
 - real-time clock and calendar, A-3
 - totalizer input, A-29
 - trigger in, A-4
 - trigger out, A-4
- Static versus dynamic measurements, B-1
- Subnet mask and default gateway, reviewing and setting, 2-42
- System operation, 1-14

—T—

TCP/IP protocol stack, H-10
TCP/IP software
 Windows, H-10
Test
 2-Wire resistance accuracy
 FAI module, 4-22
 PAI module, 4-21
 4-Wire resistance accuracy
 FAI module, 4-28
 PAI module, 4-24
 analog channel integrity, 4-20
 dc accuracy test (FAI Module), 4-17
 dc accuracy test (PAI Module), 4-16
 digital input/output, 4-29
 DIO relay/fuse, 4-30
 frequency accuracy, 4-19
 master alarm output, 4-14
 open thermocouple response, 4-20
 performance, 4-9
 totalizer, 4-31
 trigger input, 4-15
 trigger output, 4-15
 volts AC accuracy test, 4-18
Test setup
 initializing the performance, 4-11
Test setup, configuring, 4-9
Testing and troubleshooting, 2-54
Testing the Installation, 2-54
Token ring networks, H-16
Totalizer, 1-12, 2-17
 enable, 2-17
Totalizer tests, 4-31
Trend dialog, 3-12
Trigger input, 1-8, 2-8

Trigger input tests, 4-15
Trigger output, 1-8
Trigger output tests, 4-15
Trigger, alarm, 1-10
Trigger, external, 1-9
Trigger, interval, 1-9
Troubleshooting, H-14
Troubleshooting network problems, 2-58
Troubleshooting, testing and, 2-54
True-RMS measurements, C-1

—U—

Universal input module analog
 connections, 2-12
Unpacking and inspecting the device, 2-5
Using the Fluke DAQ toolbar, 3-5
UTP cables, G-1

—V—

Variations in the display, 4-35
Viewing the device Ethernet address, 2-44
Volts ac accuracy test, 4-18
Volts dc accuracy test
 FAI module, 4-17
 PAI module, 4-16

—W—

Waveform comparison (true rms vs average
 responding), C-2
Web and alarm mail settings,
 configuring, 3-42
WINSOCK DLL and application
 programming interface, H-12
Wiring, shielded, 2-15

